

HÜCO®

Automotive

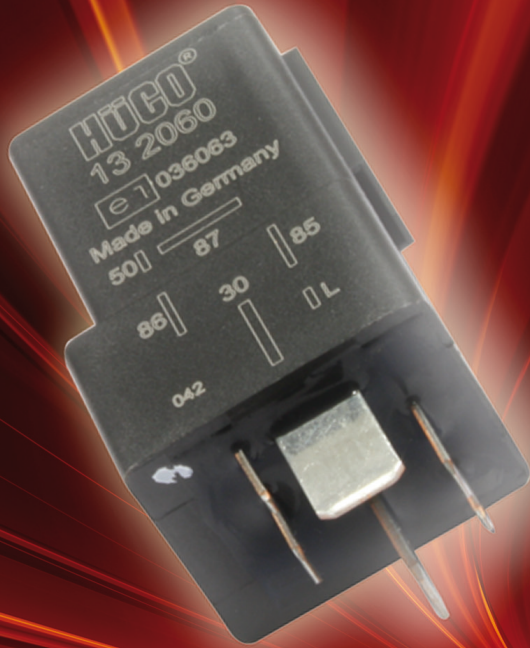

Relais / Relays Pumpen / Pumps

KRAFTSTOFFPUMPENRELAIS/FUEL PUMP RELAYS
GLÜHZEITRELAIS/GLOW PLUG CONTROLLERS
ELEKTRISCHE KRAFTSTOFFPUMPEN/ELECTRONIC FUEL PUMPS



HÜCO®

HÜCO Automotive GmbH

Eugen-Gerstenmaier-Str. 8
Postfach 12 28
32326 Espelkamp / Germany

Telefon +49 (0) 57 72 / 5 67 - 890
Telefax +49 (0) 57 72 / 5 67 - 985
E-Mail info@hueco.com
Internet www.hueco.com



subject to our guarantee terms
gemäß unseren Bedingungen



Im Bereich Automobiltechnologie steht Sicherheit an oberster Stelle.

Sicherheit in der Logistik ist die Grundlage erfolgreicher Produktion. Sicherheit in der Technik ist die Basis für einen erfolgreichen Vertrieb. Und das reibungslose Zusammenspiel von Lieferanten und Kunden gibt Sicherheit im täglichen Geschäft.

Doch wie sicher können Sie sich sein?

Kunden der HÜCO Automotive GmbH haben hier ihren entscheidenden Vorteil entdeckt; ein Produkt auf das man sich verlässt, und einen Lieferanten, dem man vertraut. Unser guter Ruf ist unser größtes Kapital - und der ist uns etwas wert. Produktionsbegleitende Qualitätssicherung und absolute Liefertreue sichern unseren Erfolg und damit den Erfolg unserer Kunden. Darum ist die HÜCO Automotive GmbH ein langjähriger Partner der Automobilindustrie.

75% Exportanteil und ein ständig wachsender Anteil am Weltmarkt bedeuten Verantwortung, und der ist sich die HÜCO Automotive GmbH bewusst.

Vertrauen fordert Verantwortung.

Die Herstellung hochwertiger Ersatzteile für den internationalen Markt für Fahrzeugelektronik ist die Aufgabe, der HÜCO sich seit über 30 Jahren erfolgreich stellt. Ob Regler oder Gleichrichter, Glühzeitrelais oder Drosselklappensensoren, Zündmodule, Zündspulen und Luftmassenmesser, Produkte der HÜCO Automotive GmbH sind immer eine sichere Alternative.

Und dafür tun wir etwas. HÜCO Automotive ist Mitglied im VDA (Verband der Automobilindustrie) und beim ZVEI (Zentralverband Elektronik und Elektroindustrie). Unser Werk in Deutschland, sowie auch unser Werk in Indien sind zertifiziert nach DIN EN ISO 9001:2000 und nach DIN ISO TS 16949:2009. Als einer der größten internationalen Hersteller im Aftermarket von Ersatzteilen für europäische und japanische Fahrzeuge liegt unser besonderes Augenmerk auf der Qualität der HÜCO Produkte und der Qualität des HÜCO Kundenservice.

Verantwortung verlangt Qualität.

Mit 4500m² Produktions- und Logistikfläche und 1500m² Bürofläche für Konstruktion, Entwicklung und Administration ist HÜCO Automotive für einen stetigen Expansionskurs auch in der Zukunft bestens gerüstet. Rund 170 hochqualifizierte Mitarbeiter im In- und Ausland schaffen Produkte, Service und Qualität und tragen damit den Erfolg von HÜCO Automotive. Denn unser Erfolg ist der Erfolg unserer Kunden.

Qualität schenkt Erfolg.

Hinweis

Die in den HÜCO Katalogen, CD-Rom und im Internet angegebenen OE Namen und Nummern dienen ausschließlich dem Vergleich. HÜCO übernimmt keine Garantie für die Richtigkeit der angegebenen Nummern und Anwendungen. Bilder und Zeichnungen entsprechen nicht in allen Fällen den zugeordneten Beschreibungen. Technische Änderungen vorbehalten.

HÜCO - at the forefront of automotive technology.

Here at HÜCO we strive to deliver the best possible service to our customers. We realise that reliability in the logistics and in our products combined with transparent cooperation between ourselves and the customer gives certainty in your daily business.

But how can you be sure?

Existing customers of HÜCO Automotive GmbH have already discovered this important advantage; a product you can rely on and a supplier you can trust. Our reputation is our most important asset and we value it greatly. Stringent quality control throughout the production process and fulfilment of delivery times ensure our success and that of our customers. This is what has established HÜCO as a premier partner in the automotive industry since our foundation.

HÜCO exports over 75% of its production and plays an important role in the constantly evolving world market, a responsibility that HÜCO is acutely aware of.

Confidence requires responsibility.

HÜCO has been a successful manufacturer of high-quality spare parts for the international automotive market for more than 30 years. Regulators, rectifiers, relays, ignition modules, ignitions coils, air flow meters or throttle-position sensors from HÜCO Automotive GmbH are always a reliable option.

And this is what we are working towards. HÜCO Automotive is a member of the VDA (Association of the Automotive Industry) and ZVEI (Central Association for Electronics and the Electronic Industry) and has been certified to DIN EN ISO 9001: 2000 for many years. HÜCO Automotive and Hueco electronic (India) Pvt. Ltd. are both certified according to DIN ISO TS 16949:2009.

As one of the leading international manufacturers for the Aftermarket of spare parts for European and Japanese vehicles we attach great importance to the quality of HÜCO products and HÜCO customer service.

Responsibility requires quality.

With a production area of 4500m² and 1500m² area for design, development and administration, HÜCO Automotive is well prepared for continuous future expansion. There are approximately 170 highly qualified and skilled employees at home and abroad who create products, service and quality and contribute to the success of HÜCO Automotive GmbH. Our success is the success of our customers.

Quality brings success.

Disclaimer

The information provided in the HÜCO catalogue, CD-Rom and in the Internet is for reference only. HÜCO assumes no responsibility for the correctness of the indicated OE names and numbers and applications. Photos and drawings do not always correspond to the descriptions they are assigned to. Subject to technical modification.

Informationssysteme

HÜCO hält eine Vielzahl von Informationssystemen für Sie bereit, mit deren Hilfe Sie sowohl einen Überblick über das komplette Produktprogramm, als auch über produktspezifische Informationen erhalten.

Der direkte Draht

Ein Anruf, eine Anfrage per Fax oder eMail genügen und Sie bekommen schnellstmöglich eine Antwort auf alle Fragen zu den Liefermöglichkeiten oder den HÜCO Produkten.

Internet

Schnell und immer aktuell - so stellt sich die Homepage der HÜCO dar. Wir informieren Sie über unsere Produkte und das Unternehmen. Im Bereich des Online Katalogs haben wir umfangreiche Suchmöglichkeiten für Sie implementiert.

Information systems

HÜCO offers you a variety of information systems that give you not only an overview of our complete product range but also contain specific information on our products.

Direct line

Just give us a call, send us a fax or email and we will respond to your queries regarding the HÜCO product range or delivery times as quickly as possible.

Internet

Our homepage is fast and up-to-date . We inform you about our products and the company. Our online catalogue has extensive search options.

www.hueco.com



Printmedien

Verschiedene Kataloge und Flyer sowie eine CD-ROM, geben Ihnen einen Überblick über die unterschiedlichen Produktlinien im Bereich der Fahrzeugelektronik.

Promotional Material

A variety of catalogues and brochures as well as a CD-ROM provide information about the different product lines in the automotive electronic range.

Nummernverzeichnis Reference List	6
Neu in diesem Katalog New in this catalogue	7
Nummernvergleichsliste Cross Reference List	8-13
Kraftstoffpumpenrelais Fuel Pump Relays	14-18
Glühzeitrelais Glow Plug Controllers	19-38
Elektrische Kraftstoffpumpen Electric Fuel Pumps	39-46
Anwendungsliste Application List	47-115
Allgemeine Verkaufs- und Lieferbedingungen / Garantiebedingungen 01/2011 Sales and Supply Conditions / Guarantee Terms 01/2011	116-119
EMV/EMC, EU-Direktive 2009/19/EG EMV/EMC, EEC-directive 2009/19/EG	120

Nummernverzeichnis Reference List

HÜCO-NO.	SEITE PAGE	HÜCO-NO.	SEITE PAGE
132000	15	132080	28
132001	15	132081	28
132010	15	132082	29
132011	16	132083	29
132014	16	132084	29
132019	16	132085	30
132020	16	132088	25
132021	17	132090	24
132022	17	132104	24
132023	17	132105	24
132030	33	132106	24
132031	34	132107	24
132032	34	132108	24
132033	35	132109	24
132034	35	132121	31
132035	36	132122	32
132036	36	132123	32
132037	37	132127	25
132038	34	132128	25
132040	18	132129	25
132041	18	132160	37
132045	23	132164	38
132050	26	132165	33
132051	26	133000	44
132052	27	133001	44
132053	27	133002	45
132057	27	133008	44
132060	22	133010	45
132061	23	133030	45
132062	23	133038	46
132063	23	133040	46
132064	22		
132065	22		
132067	22		
132071	30		
132074	31		
132075	32		
132079	31		

Neu / New

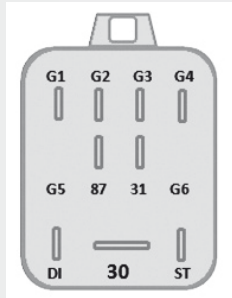

HÜCO No.	Seite / Page
132104	24
132105	24
132106	24
132107	24
132108	24
132109	24

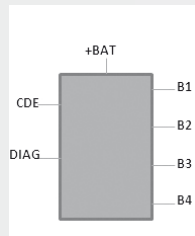
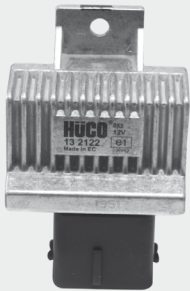

HÜCO No.	Seite / Page
132122	32

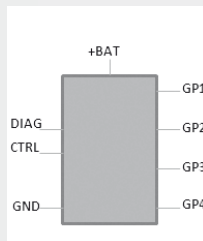

HÜCO No.	Seite / Page
132123	32

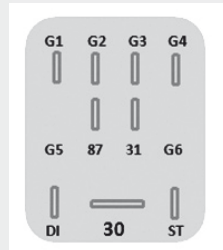

HÜCO No.	Seite / Page
132127	25
132128	25
132129	25



HÜCO No.	Seite / Page
132165	33

Nummernvergleichsliste Cross Reference List

Hersteller Manufacturers	Original No.	HÜCO-NO.	SEITE PAGE	Hersteller Manufacturers	Original No.	HÜCO-NO.	SEITE PAGE
AGRIA	44360	132052	27	BOSCH	0280230009	132040	18
ALFA ROMEO	116851104300	132019	16	BOSCH	0280230014	132041	18
ALFA ROMEO	164761113500	132041	18	BOSCH	0280230016	132010	15
ALFA ROMEO	195051104300	132040	18	BOSCH	0280230018	132040	18
ALFA ROMEO	59469230	132041	18	BOSCH	0281003005	132081	28
ALFA ROMEO	605228760	132019	16	BOSCH	0281003006	132083	29
ALFA ROMEO	605343160	132040	18	BOSCH	0281003009	132085	30
ALFA ROMEO	9619039780	132088	25	BOSCH	0281003012	132083	29
ALFA ROMEO	9639912580	132088	25	BOSCH	0281003023	132104	24
ALLIS	9619039780	132088	25	BOSCH	0281003024	132109	24
ALLIS	9639912580	132088	25	BOSCH	0281003027	132105	24
AUDI	171911261	132061	23	BOSCH	0281003038	132106	24
AUDI	171911261A	132061	23	BOSCH	0281003085	132129	25
AUDI	171911261B	132061	23	BOSCH	0281003089	132105	24
AUDI	171911261C	132061	23	BOSCH	0281003094	132104	24
AUDI	171911261D	132061	23	BOSCH	0281003096	132038	34
AUDI	171911261E	132061	23	BOSCH	0281003098	132067	22
AUDI	191911261A	132062	23	BOSCH	0281003099	132062	23
AUDI	191911261C	132062	23	BOSCH	0333402001	132052	27
AUDI	3059060591	132010	15	BOSCH	0333402501	132050	26
AUDI	321906059D	132022	17	BOSCH	0333402501	132081	28
AUDI	321906059E	132022	17	BOSCH	0333402505	132030	33
AUDI	321906059F	132022	17	BOSCH	0333402505	132038	34
AUDI	321906059G	132023	17	BOSCH	0333402506	132030	33
AUDI	321906059H	132020	16	BOSCH	0333402507	132032	34
AUDI	321911261C	132063	23	BOSCH	0333402507	132038	34
AUDI	443906059A	132022	17	BOSCH	0333402508	132032	34
AUDI	443907385	132022	17	BOSCH	0333402509	132081	28
AUDI	443907385B	132023	17	BOSCH	0333402512	132062	23
AUDI	443907385C	132020	16	BOSCH	0333402512	132061	23
AUDI	443907385E	132021	17	BOSCH	0333402513	132052	27
AUDI	443907385F	132021	17	BOSCH	0333402515	132038	34
AUDI	443907385G	132020	16	BOSCH	0333402515	132031	34
AUDI	443907385H	132020	16	BOSCH	0333402516	132031	34
AUDI	443907385J	132021	17	BOSCH	0333402517	132051	26
AUDI	443907385K	132021	17	BOSCH	0333402524	132052	27
AUDI	443911261	132061	23	BOSCH	0333402524	132051	26
AUDI	443911261A	132061	23	BOSCH	0333402525	132057	27
AUDI	443911261C	132062	23	CARTIER	02386	132050	26
AUDI	867911261C	132062	23	CARTIER	02393	132052	27
AUDI	893911261	132061	23	CARTIER	02394	132051	26
AUDI	X03952671	132040	18	CARTIER	02474	132041	18
BERU	0201010031	132062	23	CARTIER	51299011A	132088	25
BERU	0201010079	132160	23	CARTIER	51299037	132088	25
BERU	0210010001	132061	23	Citroen	598119	132081	28
BERU	0522120503	132129	25	Citroen	598124	132083	29
BERU	0522120504	132106	24	CITROEN	598143	132088	25
BERU	0522120505	132107	24	CITROEN	9640469680	132122	32
BERU	0522120702	132128	25	CITROEN	9640469680A	132122	32
BMW	13631276264	132019	16	CITROËN	598115	132051	26
BOSCH	0250201933	132061	23	CITROËN	598116	132080	28
BOSCH	0250201952	132051	26	CITROËN	598119	132081	28
BOSCH	0280230001	132019	16	CITROËN	598120	132080	28
BOSCH	0280230005	132010	15	CITROËN	598121	132085	30
BOSCH	0280230006	132041	18	CITROËN	598124	132083	29

Nummernvergleichsliste Cross Reference List

Hersteller Manufacturers	Original No.	HÜCO-NO.	SEITE PAGE	Hersteller Manufacturers	Original No.	HÜCO-NO.	SEITE PAGE
CITROËN	598126	132085	30	FIAT	1348881080	132088	25
CITROËN	598127	132085	30	FIAT	43423043	132084	29
CITROËN	598131	132088	25	FIAT	46414088	132082	29
CITROËN	598138	132088	25	FIAT	46423043	132084	29
CITROËN	91000409	132041	18	FIAT	46423043	132085	30
CITROËN	91515869	132051	26	FIAT	46428175	132053	27
CITROËN	9151586980	132051	26	FIAT	46438456	132082	29
CITROËN	91541882	132041	18	FIAT	4792112	132051	26
CITROËN	92515867	132051	26	FIAT	5946923	132041	18
CITROËN	92515869	132051	26	FIAT	5973754	132053	27
CITROËN	9549299580	132050	26	FIAT	59737540	132053	27
CITROËN	95496621	132040	18	FIAT	5990986	132051	26
CITROËN	95534787	132050	26	FIAT	60534316	132040	18
CITROËN	96117510	132080	28	FIAT	60800132	132041	18
CITROËN	96141677	132081	28	FIAT	7576067	132040	18
CITROËN	9616280080	132085	30	FIAT	75896560	132053	27
CITROËN	9616582380	132085	30	FIAT	7628059	132040	18
CITROËN	96165824	132083	29	FIAT	7664763	132053	27
CITROËN	96252036	132081	28	FIAT	76647630	132053	27
DELPHI	FDB1082	132010	15	FIAT	7717686	132010	15
DELPHI	HDC101	132050	26	FIAT	7726125	132053	27
DELPHI	HDC102	132051	26	FIAT	7735921	132082	29
DELPHI	HDC103	132052	27	FIAT	7750753	132041	18
DELPHI	HDC104	132061	23	FIAT	7750754	132040	18
DELPHI	HDC105	132065	22	FIAT	961416778	132081	28
DELPHI	HDC106	132060	22	FIAT	9614167780	132081	28
DELPHI	HDC108	132060	22	FIAT	9615938380	132085	30
DELPHI	HDC113	132064	22	FIAT	961595948	132083	29
DELPHI	HDC114	132071	30	FIAT	9619039780	132088	25
DELPHI	HDC116	132030	33	FIAT	9639912580	132088	25
DELPHI	HDC117	132032	34	FORD	1630263	132065	22
DELPHI	HDC118	132031	34	FORD	1630363	132065	22
DELPHI	HDC120	132051	26	FORD	1652479	132067	22
DELPHI	HDC122	132053	27	FORD	6107322	132000	15
DELPHI	HDC124	132075	32	FORD	6132248	132065	22
DELPHI	HDC125	132085	30	FORD	6143688	132060	22
DELPHI	HDC126	132083	29	FORD	6145938	132001	15
DELPHI	HDC127	132062	23	FORD	6171402	132065	22
DELPHI	HDC128	132090	24	FORD	6847572	132090	24
DELPHI	HDC130	132081	28	FORD	6194291	132067	22
DELPHI	HDC131	132034	35	FORD	6756611	132067	22
DELPHI	HDC132	132035	36	FORD	6756612	132067	22
DELPHI	HDC133	132036	37	FORD	82GG9P704AA	132000	15
DELPHI	HDC134	132038	34	FORD	83BB6M092A1A	132060	22
DELPHI	HDC136	132082	29	FORD	83BB6M092AA	132060	22
DELPHI	HDC137	132084	29	FORD	83BB6M092BA	132060	22
DELPHI	HDC140	132037	37	FORD	84FB006M092BA	132065	22
DELPHI	HDC141	132063	23	FORD	84FB006M092CA	132065	22
DELPHI	HDC142	132080	28	FORD	84FB006M092CB	132065	22
FERRARI	124717	132041	18	FORD	84FB6M092BA	132065	22
FERRARI	311609	132050	26	FORD	84FB6M092CA	132065	22
FERRARI	62370600	132040	18	FORD	84FB6M092CB	132065	22
FIAT	05990986	132051	26	FORD	85GG9P704AA	132001	15
FIAT	07664763	132053	27	FORD	88BG8B658AA	132060	22
FIAT	07726125	132053	27	FORD	89FB6M092AA	132067	22

Nummernvergleichsliste Cross Reference List

Hersteller Manufacturers	Original No.	HÜCO-NO.	SEITE PAGE	Hersteller Manufacturers	Original No.	HÜCO-NO.	SEITE PAGE
FORD	90BB6M092AA	132067	22	HELLA	4RV008188041	132034	35
FORD	90BB6M092BA	132067	22	HELLA	4RV008188051	132035	36
FORD	90BB6M092BB	132067	22	HELLA	4RV008188061	132036	36
FORD	90BB6M092CA	132067	22	HELLA	4RV008188071	132037	37
FORD	93BB6M092AA	132090	24	HELLA	4RV008188081	132050	26
FORD	93BB6M092BA	132090	24	HELLA	4RV008188091	132051	26
FORD	V85AB9P704AA	132041	18	HELLA	4RV008188101	132052	27
GENERAL MOTORS	090040992	132060	22	HELLA	4RV008188111	132053	27
GENERAL MOTORS	090228928	132060	22	HELLA	4RV008188151	132057	27
GENERAL MOTORS	090341822	132060	22	HELLA	4RV008188161	132060	22
GENERAL MOTORS	1238539	132014	16	HELLA	4RV008188171	132061	23
GENERAL MOTORS	1238540	132014	16	HELLA	4RV008188181	132062	23
GENERAL MOTORS	1238542	132010	15	HELLA	4RV008188191	132063	23
GENERAL MOTORS	1238549	132014	16	HELLA	4RV008188201	132064	22
GENERAL MOTORS	1238563	132011	16	HELLA	4RV008188211	132065	22
GENERAL MOTORS	1238566	132011	16	HELLA	4RV008188241	132075	32
GENERAL MOTORS	90124673	132011	16	HELLA	4RV008188271	132080	28
GENERAL MOTORS	90158189	132011	16	HELLA	4RV008188281	132081	28
GENERAL MOTORS	90158443	132011	16	HELLA	4RV008188291	132082	29
GENERAL MOTORS	90213542	132010	15	HELLA	4RV008188301	132083	29
GENERAL MOTORS	90225811	132014	16	HELLA	4RV008188311	132084	29
GENERAL MOTORS	90228928	132060	22	HELLA	4RV008188321	132085	30
GENERAL MOTORS	90230894	132014	16	HELLA	4RV008188331	132071	30
GENERAL MOTORS	90240651	132060	22	HELLA	4RV008188371	132038	34
GENERAL MOTORS	90240698	132014	16	HELLA	4RV008188381	132088	25
GENERAL MOTORS	90276101	132060	22	HELLA	4RV008188401	132090	24
GENERAL MOTORS	90341822	132060	22	IVECO	4792112	132051	26
GENERAL MOTORS	90378651	132014	16	IVECO	504013085	132109	24
GENERAL MOTORS	90464952	132045	23	IVECO	5946923	132041	18
GM	09108385	132079	31	IVECO	7750754	132040	18
GM	09110510	132075	32	IVECO	9462703	132051	26
GM	09110721	132074	31	KÄSSBOHRER	737515000	132032	34
GM	9108385	132079	31	KÄSSBOHRER	7375155000	132032	34
GM	9110510	132075	32	KÄSSBOHRER	73751591000	132030	33
GM	9110721	132074	31	LANCIA	46438456	132082	29
GM	91167210	132121	31	LANCIA	5946923	132041	18
GM	9201699	132121	31	LANCIA	9619039780	132088	25
GM	93858431	132122	32	LANCIA	9639912580	132088	25
GM	93862497	132123	32	LUCAS	DSC03	132052	25
HELLA	4RP008188331	132071	30	LUCAS	DSC04	132061	23
HELLA	4RP008189001	132000	15	LUCAS	DSC05	132065	22
HELLA	4RP008189011	132001	15	LUCAS	DSC06	132060	23
HELLA	4RP008189031	132010	15	LUCAS	DSC08	132060	23
HELLA	4RP008189041	132011	16	LUCAS	DSC13	132064	22
HELLA	4RP008189051	132014	16	LUCAS	DSC14	132071	33
HELLA	4RP008189061	132020	16	LUCAS	DSC22	132053	27
HELLA	4RP008189071	132021	17	LUCAS	FDB501	132010	15
HELLA	4RP008189081	132022	16	LUCAS	FDB501	132011	15
HELLA	4RP008189091	132023	17	LUCAS	FDB503	132000	15
HELLA	4RP008189111	132040	18	LUCAS	FDB504	132014	16
HELLA	4RP008189121	132041	18	LUCAS	FDB505	132040	18
HELLA	4RV008188001	132030	33	LUCAS	FDB506	132041	18
HELLA	4RV008188011	132031	34	LUCAS	FDB508	132020	16
HELLA	4RV008188021	132032	34	LUCAS	FDB509	132021	17
HELLA	4RV008188031	132033	35	LUCAS	FDB510	132022	17

Nummernvergleichsliste Cross Reference List

Hersteller Manufacturers	Original No.	HÜCO-NO.	SEITE PAGE	Hersteller Manufacturers	Original No.	HÜCO-NO.	SEITE PAGE
LUCAS	FDB511	132023	17	MERCEDES-BENZ	A0015459732	132030	33
LUCAS	HDC101	132050	26	MERCEDES-BENZ	A0015459832	132032	34
LUCAS	HDC102	132051	26	MERCEDES-BENZ	A0025450532	132030	33
LUCAS	HDC103	132052	27	MERCEDES-BENZ	A0025450632	132032	34
LUCAS	HDC104	132061	23	MERCEDES-BENZ	A0025450832	132030	33
LUCAS	HDC105	132065	22	MERCEDES-BENZ	A0025450932	132032	34
LUCAS	HDC106	132060	22	MERCEDES-BENZ	A0025454232	132031	34
LUCAS	HDC108	132060	22	MERCEDES-BENZ	A0025454332	132031	34
LUCAS	HDC111	132067	22	MERCEDES-BENZ	A0035452532	132033	33
LUCAS	HDC113	132064	22	MERCEDES-BENZ	A0055454032	132036	36
LUCAS	HDC114	132071	30	MERCEDES-BENZ	A0055454132	132030	33
LUCAS	HDC115	132033	35	MERCEDES-BENZ	A0055454532	132033	33
LUCAS	HDC116	132030	33	MERCEDES-BENZ	A0065452232	132164	22
LUCAS	HDC117	132032	34	MERCEDES-BENZ	A0065458832	132035	36
LUCAS	HDC118	132031	34	MERCEDES-BENZ	A0065458932	132034	35
LUCAS	HDC120	132051	26	MERCEDES-BENZ	A0065459032	132036	36
LUCAS	HDC122	132053	27	MERCEDES-BENZ	A0075451632	132037	37
LUCAS	HDC124	132075	32	MERCEDES-BENZ	A0075459832	132034	35
LUCAS	HDC125	132085	30	MERCEDES-BENZ	A0075459932	132036	36
LUCAS	HDC126	132083	29	MERCEDES-BENZ	A0085450032	132035	36
LUCAS	HDC127	132062	23	MERCEDES-BENZ	A0125458832	132160	22
LUCAS	HDC128	132090	24	MERCEDES-BENZ	A0125459032	132037	37
LUCAS	R04090001B	132085	30	MERCEDES-BENZ	A0135452432	132036	36
LUCAS	R04090001D	132085	30	MERCEDES-BENZ	A0155453032	132037	37
LUCAS	R04090002C	132083	29	MERCEDES-BENZ	A0255455432	132038	34
LUCAS	R0409002C	132083	29	MONARK	90290001	132061	23
MAGIRUS-DEUTZ	4792112	132051	26	NAGARES	BDL712	132122	32
MAGNETI MARELLI	REP1A	132050	26	NAGARES	BED712	132121	31
MERCEDES-BENZ	0015450532	132032	34	NAGARES	BRE312	132074	31
MERCEDES-BENZ	0015459732	132030	33	NAGARES	BRE512	132079	31
MERCEDES-BENZ	0015459832	132032	24	NAGARES	BRE612	132074	31
MERCEDES-BENZ	0025450532	132030	33	NAGARES	CEP612	132088	25
MERCEDES-BENZ	0025450632	132032	34	NAGARES	FGPR812	132123	32
MERCEDES-BENZ	0025450832	132030	33	NAGARES	PPX512	132081	28
MERCEDES-BENZ	0025450932	132032	34	NAGARES	TPD1212	132050	26
MERCEDES-BENZ	0025454232	132031	34	NAGARES	TPD512	132051	26
MERCEDES-BENZ	0025454332	132031	34	NAGARES	TPD612	132052	27
MERCEDES-BENZ	0035452532	132033	35	NAGARES	TRM1212	132075	32
MERCEDES-BENZ	0055454032	132036	36	NAGARES	TRMA1212	132075	32
MERCEDES-BENZ	0055454132	132030	33	NAGARES	TRMK1212	132075	32
MERCEDES-BENZ	0055454532	132033	33	NISSAN	11067JD50C	132123	32
MERCEDES-BENZ	0065452232	132164	38	OPEL	1238532	132060	22
MERCEDES-BENZ	0065458832	132035	36	OPEL	1238537	132060	22
MERCEDES-BENZ	0065458932	132034	35	OPEL	1238539	132014	16
MERCEDES-BENZ	0065459032	132036	36	OPEL	1238540	132014	16
MERCEDES-BENZ	0075451632	132037	37	OPEL	1238542	132010	15
MERCEDES-BENZ	0075459832	132034	35	OPEL	1238549	132014	16
MERCEDES-BENZ	0075459932	132036	36	OPEL	1238563	132011	16
MERCEDES-BENZ	0085450032	132035	36	OPEL	1238565	132060	22
MERCEDES-BENZ	0125458832	132160	22	OPEL	1238566	132011	16
MERCEDES-BENZ	0125459032	132037	37	OPEL	1238627	132060	22
MERCEDES-BENZ	0135452432	132036	36	OPEL	1238966	132014	16
MERCEDES-BENZ	0155453032	132037	37	OPEL	2523080A0A	132123	32
MERCEDES-BENZ	0255455432	132038	34	OPEL	4400385	132079	31
MERCEDES-BENZ	A0015450532	132032	34	OPEL	4402510	132075	32

Nummernvergleichsliste Cross Reference List

Hersteller Manufacturers	Original No.	HÜCO-NO.	SEITE PAGE	Hersteller Manufacturers	Original No.	HÜCO-NO.	SEITE PAGE
OPEL	4402721	132074	31	RENAULT	7700757776	132052	27
OPEL	4409990	132121	31	RENAULT	7700790579	132075	32
OPEL	4416764	132122	32	RENAULT	7700851443	132075	32
OPEL	4419200	132123	32	RENAULT	7700863454	132075	32
OPEL	4506156	132121	31	RENAULT	7700867374	132075	32
OPEL	6237339	132045	23	RENAULT	7702089784	132052	27
OPEL	90040992	132060	22	RENAULT	8200859243	132123	32
OPEL	90228928	132060	22	RENAULT	9611751080	132080	28
OPEL	90341822	132060	22	RENAULT	9617240680	132080	28
PARIS-RHONE	102180M	132050	26	ROVER	NCJ100110	132085	30
PARIS-RHONE	102696	132051	26	ROVER	PRC5020	132050	26
PARIS-RHONE	105857	132050	26	SAME	000871074	132052	27
PEUGEOT	145205	132041	18	SEAT	0581CR01	132051	26
PEUGEOT	598110	132050	26	SEAT	0581CR1	132051	26
PEUGEOT	598111	132051	26	SEIM	0587900	132050	26
PEUGEOT	598113	132050	26	SEIM	06421900	132051	26
PEUGEOT	598115	132051	26	SEIM	08110900	132052	27
PEUGEOT	598119	132081	28	SIEMENS	5WK2205	132022	17
PEUGEOT	598121	132085	30	SSANGYONG	6625453032	132036	37
PEUGEOT	598124	132083	29	SSANGYONG	6625453532	132036	36
PEUGEOT	598125	132088	25	STEYR	71618502101	132061	23
PEUGEOT	598126	132085	30	STRIBEL	899063000	132165	22
PEUGEOT	598127	132085	30	STRIBEL	899095000	132108	24
PEUGEOT	598131	132088	25	STRIBEL	899097000	132108	24
PEUGEOT	598138	132088	25	TALBOT	598111	132051	26
PEUGEOT	598143	132088	25	TALBOT	9121586980	132051	26
PEUGEOT	655522	132040	18	TALBOT	9151586980	132051	26
PEUGEOT	655547	132041	18	TALBOT	9251586780	132051	26
PEUGEOT	7920076593	132050	26	TALBOT	9251586980	132051	26
PEUGEOT	9100040980	132041	18	TALBOT	9614167780	132081	28
PEUGEOT	9151586980	132051	26	TALBOT	B515867	132051	26
PEUGEOT	9250883280	132050	26	VAG	038907281A	132104	24
PEUGEOT	9250888280	132050	26	VAG	038907281B	132129	25
PEUGEOT	9251586780	132051	26	VAG	038907281C	132105	24
PEUGEOT	9251586980	132051	26	VAG	038907281D	132106	24
PEUGEOT	95496621	132040	18	VAG	03G907282	132128	25
PEUGEOT	9601329480	132041	18	VAG	03G907282A	132107	24
PEUGEOT	96141677	132081	28	VAG	03L907281	132108	24
PEUGEOT	9616280080	132085	30	VAG	03L907282	132127	25
PEUGEOT	96165824	132083	29	VALEO	102696	132051	26
PEUGEOT	96252036	132081	28	VALEO	245600	132050	26
PEUGEOT	9625203680	132081	28	VALEO	245603	132051	26
PEUGEOT	9640469680	132122	32	VALEO	245604	132052	27
PEUGEOT	9640469680A	132122	32	VALEO	245607	132075	32
PEUGEOT	9999163554	132041	18	VALEO	245609	132080	28
RENAULT	5000409614	132064	22	VALEO	245612	132080	28
RENAULT	7700100703	132074	31	VALEO	245618	132088	25
RENAULT	7700109860	132079	31	VALEO	73100122	132050	26
RENAULT	7700111525	132074	31	VALEO	73101002	132050	26
RENAULT	7700115078	132121	31	VALEO	73103402	132051	26
RENAULT	7700702747	132052	27	VALEO	73104822	132052	27
RENAULT	7700708960	132019	16	VALEO	73104902	132080	28
RENAULT	7700715675	132010	15	VALEO	73105002	132051	26
RENAULT	7700721268	132041	18	VALEO	73506302	132080	28
RENAULT	7700751089	132052	27	VAUXHALL	090040992	132060	22

Nummernvergleichsliste

Cross Reference List

Hersteller Manufacturers	Original No.	HÜCO-NO.	SEITE PAGE	Hersteller Manufacturers	Original No.	HÜCO-NO.	SEITE PAGE
VAUXHALL	090228928	132060	22				
VAUXHALL	090341822	132060	22				
VAUXHALL	091097769	132060	22				
VAUXHALL	091108750	132060	22				
VAUXHALL	90040992	132060	22				
VAUXHALL	90228928	132060	22				
VAUXHALL	90341822	132060	22				
VOLVO	1326730	132010	15				
VOLVO	1363438	132071	30				
VOLVO	285227	132010	15				
VOLVO	3285227	132010	15				
VOLVO	35601160	132060	22				
VOLVO	3650116	132060	22				
VOLVO	9162987	132071	30				
VW	038907281B	132129	25				
VW	03G907282	132128	25				
VW	171911261	132061	23				
VW	171911261A	132061	23				
VW	171911261B	132061	23				
VW	171911261C	132061	23				
VW	171911261D	132061	23				
VW	171911261E	132061	23				
VW	191911261A	132062	23				
VW	191911261C	132062	23				
VW	2D0911253	132165	33				
VW	3059060591	132010	15				
VW	321906059D	132022	17				
VW	321906059E	132022	17				
VW	321906059F	132022	17				
VW	321906059G	132023	17				
VW	321906059H	132020	16				
VW	321911261C	132063	23				
VW	443906059A	132022	17				
VW	443907385	132022	17				
VW	443907385B	132023	17				
VW	443907385C	132020	16				
VW	443907385E	132021	17				
VW	443907385F	132021	17				
VW	443907385G	132020	16				
VW	443907385H	132020	16				
VW	443907385J	132021	17				
VW	443907385K	132021	17				
VW	443911261	132061	23				
VW	443911261A	132061	23				
VW	443911261C	132062	23				
VW	867911261C	132062	23				
VW	893911261	132061	23				
VW	X03952671	132040	18				
WEHRLE	51299007A	132088	25				
WLO	WLO51299023A	132106	24				

Beschreibung Kraftstoffpumpenrelais Description Fuel Pump Relays

Kraftstoffpumpenrelais sind aus Sicherheitsgründen für jedes Fahrzeug vorgeschrieben. Da die Kraftstoffpumpe bei einem Unfall und einer dadurch beschädigten Kraftstoffleitung möglichst keinen Kraftstoff auf die Straße fördern soll, ist das Kraftstoffpumpenrelais mit einer Sicherheitsschaltung versehen.

Über das Relais wird beim Starten des Fahrzeuges die Kraftstoffpumpe eingeschaltet. Die Elektronik im Relais überwacht ständig, ob der Motor läuft. Sollte der Motor z.B. bei einem Unfall stehen bleiben, schaltet das Relais nach ca. 1-2 Sekunden die Pumpe ab.

Fuel pump relays are compulsory safety units for any vehicles. They are provided with a protection circuit, because the fuel pump should not pump any fuel on the street in case of an accident or a damaged fuel pipe.

The fuel pump of the vehicle is switched on via the relay when starting the car's engine. The electronic circuit of the relay checks if the motor is running. In case the motor is suddenly switched off, e.g. in case of an accident, the relay will cut the power supply to the fuel pump within 1-2 seconds.



Kraftstoffpumpenrelais Fuel Pump Relays

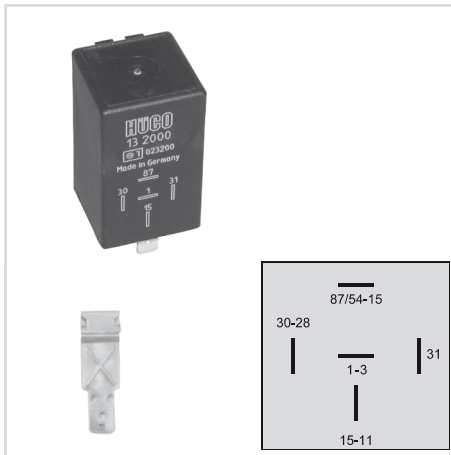

ORIGINAL- UND O.E.M.-NO.

FORD
6107322 82GG9P704AA
HELLA
4RP008189001
LUCAS
FDB503

HÜCO-NO.

13 2000

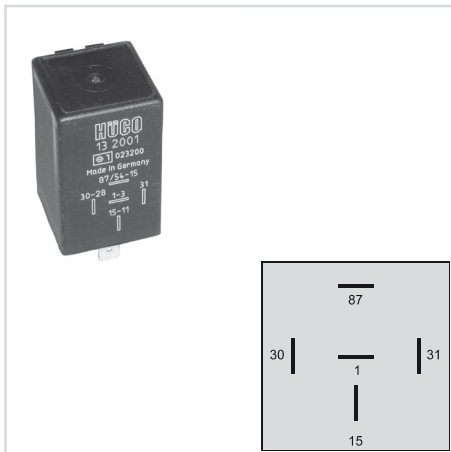

ORIGINAL- UND O.E.M.-NO.

FORD
6145938 85GG9P704AA
HELLA
4RP008189011

HÜCO-NO.

13 2001

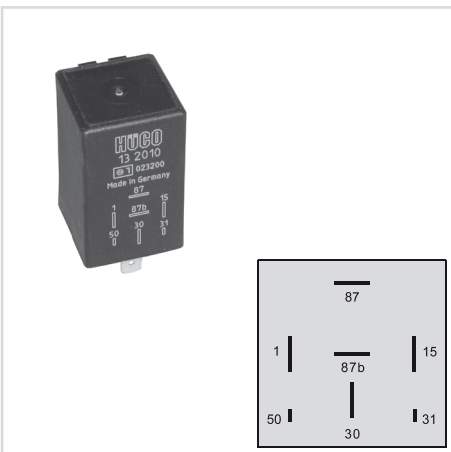

ORIGINAL- UND O.E.M.-NO.

AUDI / VW
3059060591
BOSCH
0280230005 0280230016
DELPHI
FDB1082
FIAT
7717686
GENERAL MOTORS
1238542 90213542
HELLA
4RP008189031
LUCAS
FDB501
OPEL
1238542
RENAULT
7700715675
VOLVO
1326730 285227 3285227

HÜCO-NO.

13 2010

Kraftstoffpumpenrelais Fuel Pump Relays

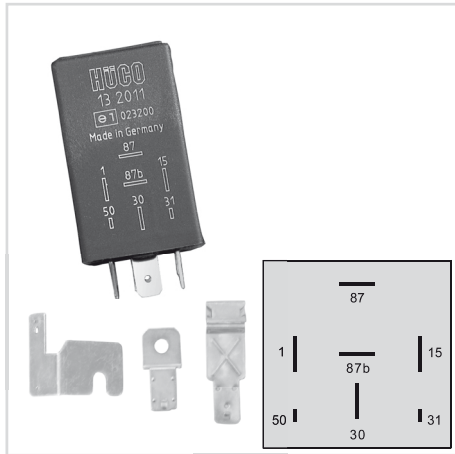

ORIGINAL- UND O.E.M.-NO.

GENERAL MOTORS

1238563 1238566 90124673
90158189 90158443

HELLA
4RP008189041

LUCAS
FDB501

OPEL
1238563 1238566

HÜCO-NO.

13 2011

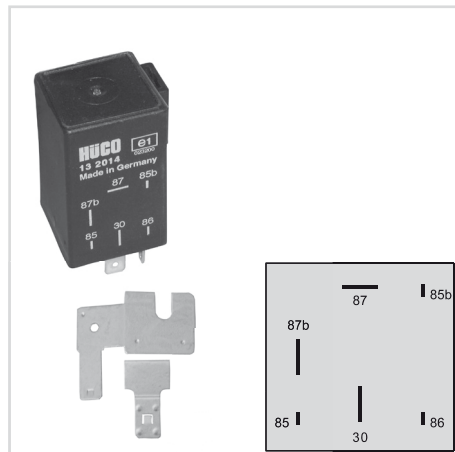

ORIGINAL- UND O.E.M.-NO.

GENERAL MOTORS

1238539 1238540 1238549
90225811 90230894 90240698
90378651

HELLA
4RP008189051

LUCAS
FDB504

OPEL
1238539 1238540 1238549
1238966

HÜCO-NO.

13 2014

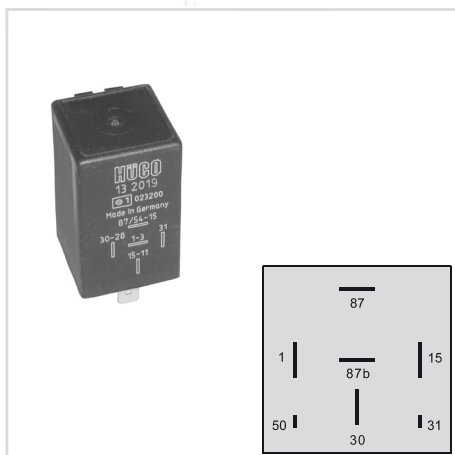

ORIGINAL- UND O.E.M.-NO.

ALFA ROMEO

116851104300 605228760

BMW
13631276264

BOSCH
0280230001

FIAT
60522876

RENAULT
7700708960

HÜCO-NO.

13 2019

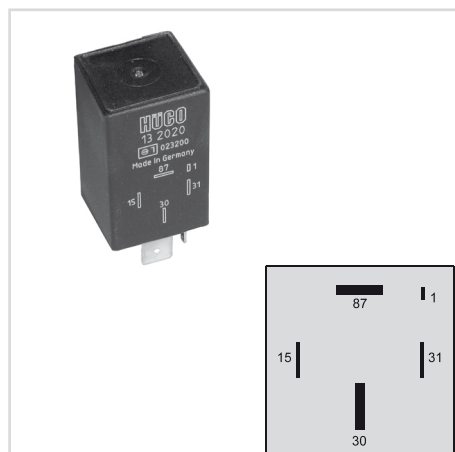

ORIGINAL- UND O.E.M.-NO.

AUDI / VW

321906059H 443907385C 443907385G
443907385H

HELLA
4RP008189061

LUCAS
FDB508

HÜCO-NO.

13 2020

Kraftstoffpumpenrelais

Fuel Pump Relays

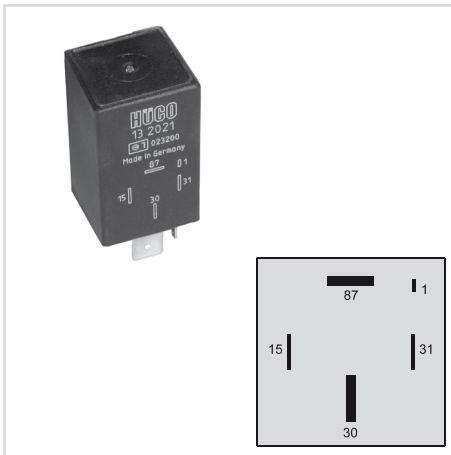

ORIGINAL- UND O.E.M.-NO.

AUDI / VW
 443907385E 443907385F 443907385J
 443907385K
HELLA
 4RP008189071
LUCAS
 FDB509

HÜCO-NO.

13 2021

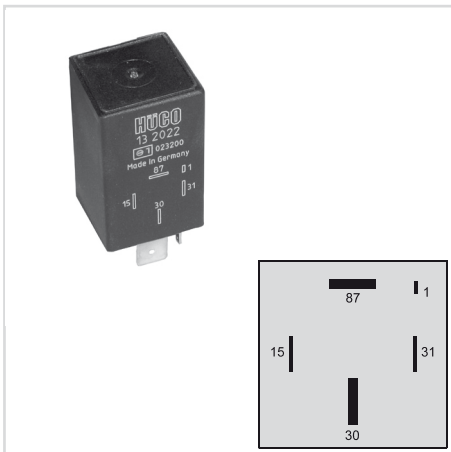

ORIGINAL- UND O.E.M.-NO.

AUDI / VW
 321906059D 321906059E 321906059F
 443906059A 443907385
HELLA
 4RP008189081
LUCAS
 FDB510
SIEMENS
 5WK2205

HÜCO-NO.

13 2022



ORIGINAL- UND O.E.M.-NO.

AUDI / VW
 321906059G 443907385B
HELLA
 4RP008189091
LUCAS
 FDB511

HÜCO-NO.

13 2023

Kraftstoffpumpenrelais Fuel Pump Relays

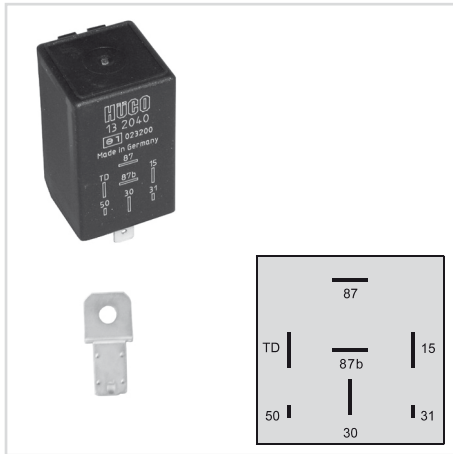

ORIGINAL- UND O.E.M.-NO.

HÜCO-NO.

ALFA ROMEO		
195051104300	605343160	
AUDI		
X03952671		
BOSCH		
0280230009	0280230018	
CITROËN		
95496621		
FERRARI		
62370600		
FIAT		
60534316	7576067	7628059
7750754		
HELLA		
4RP008189111		
IVECO		
7750754		
LUCAS		
FDB505		
PEUGEOT		
655522	95496621	

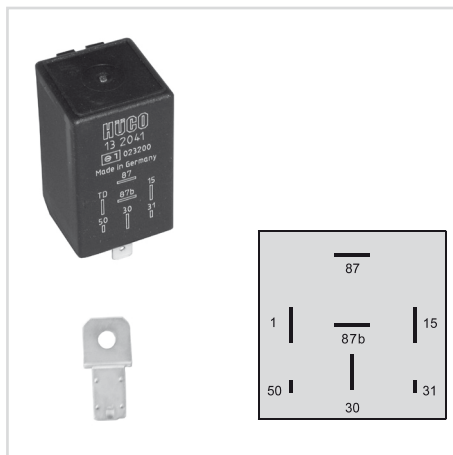

ORIGINAL- UND O.E.M.-NO.

HÜCO-NO.

ALFA ROMEO		
164761113500	59469230	
BOSCH		
0280230006	0280230014	
CARTIER		
2474		
CITROËN		
91000409	91541882	
FERRARI		
124717		
FIAT		
5946923	60800132	7750753
FORD		
V85AB9P704AA		
HELLA		
4RP008189121		
IVECO		
5946923		
LANCIA		
5946923		
LUCAS		
FDB506		
PEUGEOT		
145205	655547	9100040980
9601329480	9999163554	
RENAULT		
7700721268		

Glühzeitrelais Diesel / Glow Plug Controllers

Beschreibung / Description

Funktion

Dieselmotoren sind so genannte Selbstzünder. Das heißt, dass keine zusätzliche Energiequelle benötigt wird, um das Gemisch im Zylinder zu zünden. Das Luft-/Diesel-Gemisch wird im Zylinder hoch verdichtet. Dadurch entsteht eine so hohe Temperatur, dass sich das Gemisch von selbst entzündet und zur Explosion kommt. Dieser Vorgang läuft jedoch nur bei einem heißen Motor problemlos ab. Bei kalten Temperaturen ist das Luft-/Diesel-Gemisch nicht so zündfreudig. Zur sicheren Verbrennung bei kaltem Motor werden als Zündhilfe Glühkerzen (je eine pro Zylinder) eingesetzt. Die Glühkerze erhöht vor dem Starten des Motors die Temperatur im Brennraum des Zylinders. An der Spitze erreicht die Glühkerze eine Temperatur von bis 1.000 °C. Dadurch kann das Luft-/Diesel-Gemisch selbst bei niedrigen Temperaturen sicher zum Explodieren gebracht werden.

Die benötigte Zeit für das „Vorglühen“ sind je nach verwendeter Glühkerze unterschiedlich. Es gibt Schnellglühkerzen, die eine Vorglühzeit von nur wenigen Sekunden benötigen. Andere Glühkerzen müssen bei niedrigen Umgebungstemperaturen bis zu 15 Sekunden vorgeglüht werden. Das Glühzeitrelais hat die Aufgabe, das Ein- und Ausschalten des Stromes für die Glühkerzen und die Zeitsteuerung zu übernehmen.

Für das Ein- und Ausschalten des Stroms für die Glühkerzen sind im Glühzeitrelais (Steuergerät für die Glühzeit) Schalter verbaut – so genannte Leistungsrelais. Glühkerzen benötigen, wenn sie bereits heiß sind, einen Strom von ca. 10 Ampere. In der Einschaltphase (bei kalter Glühwendel) ist der Strom jedoch wesentlich höher. Bei einem 4-Zylinder Motor müssen die Leistungsrelais Ströme von bis zu 80 Ampere schalten können. Bei 6- oder 8-Zylinder Motoren entsprechend mehr. Oft werden deshalb die anzusteuern Glühkerzen auf zwei Stromkreise aufgeteilt. Entsprechend befinden sich dann innerhalb des Glühzeitrelais zwei Leistungsrelais.

Bei der Zeitsteuerung müssen mehrere Phasen berücksichtigt werden:

1. Die Vorglühzeit. Die Vorglühzeit ist abhängig vom Motor-Typ, den verwendeten Glühkerzen und der mit Hilfe eines Sensors gemessenen Umgebungstemperatur. Die Temperatursensoren können sich je nach Relais-Typ sowohl im Relais selbst, als auch extern, etwa im Kühlmittelkreislauf befinden. Im Winter, bei Minusgraden, ist die Vorglühzeit wesentlich länger als im Sommer bei z.B. +30 °C. Während der Vorglühzeit leuchtet die Vorglüh-Kontrolllampe im Armaturenbrett. Bei einigen Fahrzeugen beginnt die Vorglühzeit bereits, wenn der Fahrer die Fahrertür öffnet.

2. Die Bereitstellungszeit. Sie beginnt direkt nach der Vorglühzeit. Die Kontrolllampe geht nun aus, die Glühkerzen bleiben jedoch für ein paar weitere Sekunden eingeschaltet. In dieser Zeit sollte der Motor vom Fahrer gestartet werden.

3. Die Nachglühzeit. Die Nachglühzeit wurde bei neueren Fahrzeugen eingeführt. Erforderlich wurde dies durch die immer strengeren Abgasnormen und der damit notwendigen Optimierung der Verbrennungsabläufe im Zylinder. Die Glühkerzen bleiben während der Nachglühzeit auch bei laufendem Motor weiter eingeschaltet. Die Länge der Nachglühzeit ist abhängig vom Motor-Typ und der Motortemperatur. Für diese Funktion kommen nur spezielle „nachglühfähige“ Glühkerzen zum Einsatz.

Varianten

Auch wenn die technische Grundfunktion immer die Gleiche ist, gibt es Glühzeitrelais in vielen unterschiedlichen Varianten. Sowohl die Größen der Gehäuse, die Anschlussstecker als auch die Befestigungsart sind unterschiedlich. Allein für die in Europa hergestellten Fahrzeuge gibt es über 100 verschiedene Relais-Typen. Es gibt auch Vorglühsysteme, bei denen die Funktion der Zeitsteuerung vom Motorsteuergerät übernommen wird. Das Glühzeitrelais hat dann lediglich die Aufgabe, die erforderlichen hohen Ströme für die Glühkerzen zu schalten.

Vollelektronische Glühzeitrelais

Bei diesen modernen Typen der Glühzeitrelais ist alles anders. Sie sind diagnosefähig und an die On Board Diagnose (OBD) angeschlossen. Vollelektronische Glühzeitrelais sind Steuergeräte, die über einen Daten-Bus mit dem Motorsteuergerät verbunden

Funktion

Diesel engines are so called self-igniting engines. That means that they don't require an additional energy source to ignite the diesel/air mixture in the cylinder. The diesel/air mixture is compressed so highly within the cylinder that a high temperature results in a self-ignition of the mixture and thus an "explosion". This procedure however only occurs within an already hot or warm engine. Whenever the engine temperature is colder glow plugs ensure the ignition process can start accordingly. The glow plugs (1 per cylinder) pre-heat the temperature within the ignition chamber of the individual cylinder. The tip of the glow plug reaches a temperature of approx. 1000°C. This ensures a reliable ignition process of the air/diesel mixture even during very low temperatures.

The required time for the pre-heating of the glow plugs varies depending on which type of glow plug is used. High speed glow plugs only require a pre-heating time of a few seconds; others must be pre-heated up to 15 seconds when experiencing low ambient temperatures. The glow plug controller regulates the on/off switching of the required electricity and thus the pre-heating time itself.

Switches (power relays) located within the glow plug relay are responsible for turning the electric current of the glow plugs on and off. A current of approx. 10 Ampere is necessary for an already hot glow plug. However, in case the engine is cold, the necessary current is much higher. The power relay needs to be able to switch a current of up to 80 Ampere in case of a 4 cylinder engine. For 6 or 8 cylinder engines it's even higher. It's often the case that the electricity is split into 2 individual circuits. In these cases the glow plug relay will contain 2 separate power relays.

During the time control several phases must be considered:

1. Pre-Heating Time

The pre-heating depends on the motor type, the used glow plugs and the ambient temperature measured with a sensor. The temperature sensors can be located in the relay – or in an external position such as within the cooling cycle. In winter months with sub-zero temperatures the pre-heating time is much longer than in summer months with temperatures up to +30°C. During the pre-heating time the pre-heating lamp in the car's dashboard is active. Some passenger cars even start the pre-heating time once the driver's door has been opened.

2. Supply Time

The supply time begins directly after the pre-heating time. The control lamp is switched off; however the glow plugs themselves remain active for a few more seconds. At this point the driver should start the car's engine.

3. Post-Heating Time

Post-Heating was established for newer car models in order to optimize the combustion sequences within the engine and thus ensure better and lower exhaust gas emissions. The glow plugs are switched on during the post-heating time while the engine is running. The duration of the post-heating time is dependent on factors such as engine temperature or the type of engine itself. Special glow plugs, so-called posting-glowing types, are required in these cases.

Variants

Even if the technical basis function is always the same, you can find glow plug controllers in many different variants. Both the sizes of the housing, the connectors and the type of mounting are different. However for the vehicles manufactured in Europe there are over 100 different relay types. There are also pre-heating systems where the function of the timing is taken over by the engine controller. Then the glow plug controller only has the function to switch the necessary high current for the glow plugs.

Full electronic glow plug controller

With these modern types of glow plug controllers everything is different. They are diagnosticable and attached to the On Board Diagnosis (OBD). Full electronic glow plug controllers are connected with the engine

sind. Das Motorsteuergerät gibt die Befehle für das Ein- und Ausschalten. Außerdem wird gemessen, ob nach dem Einschalten einer Glühkerze tatsächlich ein genügend hoher Strom fließt. Dies wird dann über ein Quittungssignal dem Motorsteuergerät zurückgemeldet. Sollte ein zu hoher Strom (z.B. bei einem Kurzschluss im Kabel oder Glühkerze) erkannt werden, wird der entsprechende Stromzweig abgeschaltet, um eine Zerstörung der Elektronik zu verhindern.

Eine weitere Besonderheit vollelektronischer Glühzeitrelais ist, dass keine Relais mehr zum Ein- und Ausschalten verwendet werden, sondern Leistungstransistoren (elektronische Schalter). Dadurch kann der Strom für die Glühkerzen nicht nur ein- und ausgeschaltet, sondern auch die Stromstärke verändert werden. Dieses geschieht durch ein veränderbares Tastverhältnis. Das heißt, dass der Strom während der Stromregelphase in sehr kurzen Zeitintervallen ein- und ausgeschaltet wird. Ist die Einschaltzeit länger als die Ausschaltzeit, erhält die Glühkerze mehr Leistung und wird heißer. Umgekehrt wird die Glühkerze weniger heiß, wenn die Einschaltzeiten kürzer sind als die Ausschaltzeiten.

Glühzeitrelais werden an den unterschiedlichsten Stellen im Fahrzeug verbaut. Steckrelais sind vorwiegend im zentralen Relaiskasten zu finden. Relais, die keine Steckkontakte für die Zuleitung zu den Glühkerzen haben, sondern Kabelschuhe die angeschraubt werden, sind im Motorraum zu finden. Diese Relais sind direkt am Spritzblech oder mit speziellen Befestigungswinkeln an der Karosserie angeschraubt.

controller via data bus. The engine controller transmits the instructions for switching on or off. It is also measured if enough current is flowing after switching on a glow plug. The engine controller is informed about this via acknowledgement signal. If a current is too high (e.g. in case of a short circuit in the cable or glow plug) this should be recognized, the appropriate branch circuit is switched off in order to avoid destruction of electronic.

Another characteristic of all electronic glow plug controllers is, that there is no need for a relay to switch the glow plug controller off an on, but power transistors (electronic switches). Thus the current can not only be switched on and off but also changed in amperage. This is done via a changable duty cycle. This means the current is switched on and off during the current cycle control in short time intervalls. If the „on-time“ is longer than the „out-time“ the glow plug gets more power and becomes hotter. The glow plug is turned aroundl less hot if the „on-time“ is shorter than the „off-time“.

Glow plug controllers are mounted into different places of the car. Plug-in relays can be found in the central relay box. Relays without plug-in contact for glow plug controllers, but plug contacts to be screwed are found in the engine compartement. These relays are screwed directly at the splash guard or with special attaching brackets onto the body.

Glühzeitrelais Diesel Glow Plug Controllers

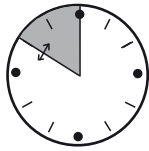
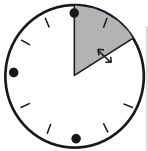
HÜCO NO.	Vorglühzeit preheating time in sec bei +20°C in sec at +20°C		Nachglühzeit / postheating time mit/with		Temperatur- messung/ temperature measurement		Besonderheit characteristic
					intern internal	extern external	
13 2030	<9			●	●		mit Fehlererkennung / with defect warning
13 2031	<9			●	●		mit Fehlererkennung / with defect warning
13 2032	<9			●	●		mit Fehlererkennung / with defect warning
13 2033	<9			●	●		mit Fehlererkennung / with defect warning
13 2034	<9		●			●	mit Fehlererkennung / with defect warning
13 2035	<9		●			●	mit Fehlererkennung / with defect warning
13 2036	<9		●			●	mit Fehlererkennung / with defect warning
13 2037	<9		●			●	mit Fehlererkennung / with defect warning
13 2038	<7		●		●		
13 2045	<5			●	●		
13 2050	<14			●	●		
13 2051	<8			●	●		
13 2052	<9			●	●		
13 2053	<7		●		●		
13 2057	<5		●		●		
13 2060	<8			●	●		
13 2061	<8		●			●	
13 2062	<7		●			●	
13 2063	<18			●		●	
13 2064	<13			●	●		
13 2065	<8		●		●		
13 2067	<6		●		●		
13 2071	<12		●			●	
13 2074					●		Ansteuerung über Motorelektronik / Control over motor electronics mit Fehlererkennung / with defect warning
13 2075	<10		●			●	getaktete Nachglühzeit / pulse & post heating time
13 2079					●		Ansteuerung über Motorelektronik / Control over motor electronics mit Fehlererkennung / with defect warning
13 2080	<10			●	●		Kodierung am Stecker / coding at plug
13 2081	<7		●		●		mit Nachglühunterbrechung / with post heating cut out
13 2082	<9		●			●	
13 2083	<8		●			●	
13 2084	<12		●		●		
13 2085	<8		●			●	mit Nachglühunterbrechung / with post heating cut out
13 2088			●		●		
13 2090	<7		●		●		Ansteuerung über Motorelektronik / Control over motor electronics
13 2104					●		Ansteuerung über Motorelektronik / Control over motor electronics mit Fehlererkennung / with defect warning
13 2105					●		Ansteuerung über Motorelektronik / Control over motor electronics mit Fehlererkennung / with defect warning
13 2106					●		Ansteuerung über Motorelektronik / Control over motor electronics mit Fehlererkennung / with defect warning
13 2107					●		Ansteuerung über Motorelektronik / Control over motor electronics mit Fehlererkennung / with defect warning
13 2108					●		Ansteuerung über Motorelektronik / Control over motor electronics mit Fehlererkennung / with defect warning
13 2109					●		Ansteuerung über Motorelektronik / Control over motor electronics mit Fehlererkennung / with defect warning
13 2121					●		Ansteuerung über Motorelektronik / Control over motor electronics mit Fehlererkennung / with defect warning
13 2122					●		Ansteuerung über Motorelektronik / Control over motor electronics mit Fehlererkennung / with defect warning
13 2123					●		Ansteuerung über Motorelektronik / Control over motor electronics mit Fehlererkennung / with defect warning
13 2127					●		Ansteuerung über Motorelektronik / Control over motor electronics mit Fehlererkennung / with defect warning
13 2128					●		Ansteuerung über Motorelektronik / Control over motor electronics mit Fehlererkennung / with defect warning
13 2129					●		Ansteuerung über Motorelektronik / Control over motor electronics mit Fehlererkennung / with defect warning
13 2160	<9		●			●	
13 2165						●	Steuerung über Temp. Sensor / Control over temp. sensor

Technische Änderungen vorbehalten - Subject to technical modifications

Glühzeitrelais Diesel Glow Plug Controllers

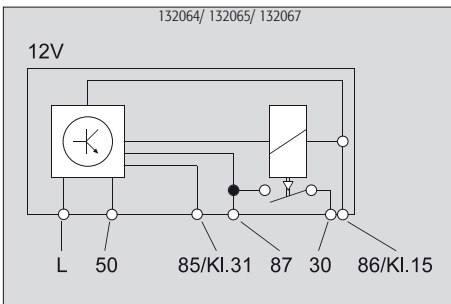
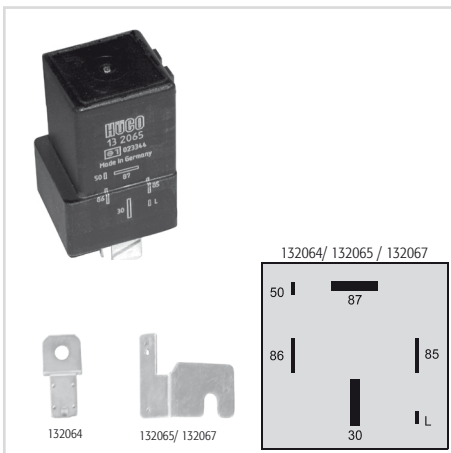
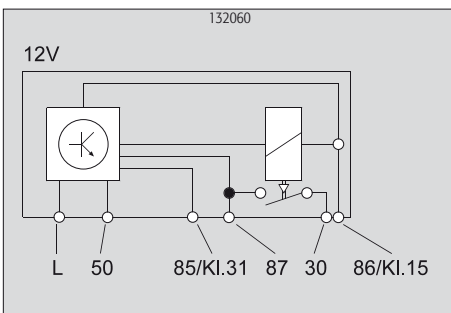
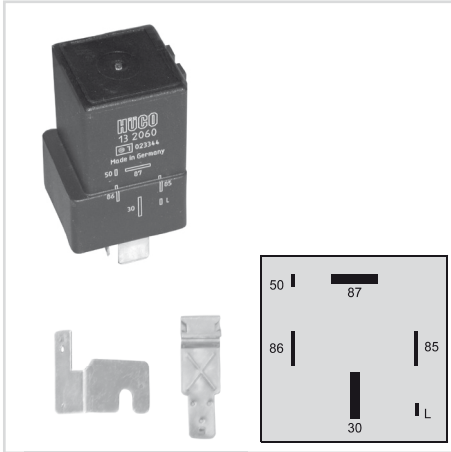

ORIGINAL- UND O.E.M.-NO.

HÜCO-NO.

DELPHI			
HDC106	HDC108		
FORD			
6143688	83BB6M092A1A	83BB6M092AA	
83BB6M092BA	88BG8B658AA		
GENERAL MOTORS			
90040992	90228928	90341822	90228928
90240651	90276101	90341822	
HELLA			
4RV008188161			
LUCAS			
DSC06	DSC08	HDC106	HDC108
OPEL			
1238532	1238537	1238565	1238627
90040992	90228928	90341822	
VAUXHALL			
90040992	90228928	90341822	91097769
91108750	90040992	90228928	90341822
VOLVO			
35601160	3650116		

13 2060

ORIGINAL- UND O.E.M.-NO.

HÜCO-NO.

DELPHI		
HDC113		
HELLA		
4RV008188201		
LUCAS		
DSC13	HDC113	
RENAULT		
5000409614		

13 2064

DELPHI

HDC105

FORD

1630263

6171402

84FB006M092CB

84FB6M092CB

HELLA

4RV008188211

LUCAS

DSC05

1630363

84FB006M092BA

84FB6M092BA

HDC105

6132248

84FB006M092CA

84FB6M092CA

mit Nachglühzeit / with post heating time

HÜCO-NO.

13 2065

BOSCH

0281003098

FORD

1652479

6756612

90BB6M092BA

LUCAS

DSC11

6194291

89FB6M092AA

90BB6M092BB

HDC111

6756611

90BB6M092AA

90BB6M092CA

mit Nachglühzeit / with post heating time

HÜCO-NO.

13 2067

Glühzeitrelais Diesel Glow Plug Controllers

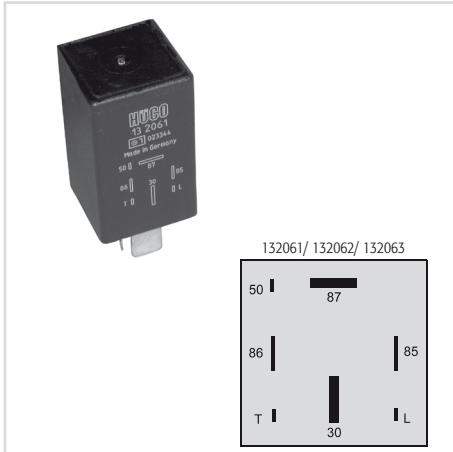

ORIGINAL- UND O.E.M.-NO.

AUDI / VW
 171911261 171911261A 171911261B
 171911261C 171911261D 171911261E
 443911261 443911261A 893911261

BERU
 0210010001

BOSCH
 0250201933 0333402512

DELPHI
 HDC104

HELLA
 4RV008188171

LUCAS
 DSC04 HDC104

MONARK
 90290001

STEYR
 71618502101

HÜCO-NO.

13 2061

mit Nachglühzeit / with post heating time

AUDI / VW
 191911261A 191911261C 443911261C
 867911261C

BERU
 0201010031

BOSCH
 0281003099 0333402512

DELPHI
 HDC127

HELLA
 4RV008188181

LUCAS
 HDC127

HÜCO-NO.

13 2062

mit Nachglühzeit / with post heating time

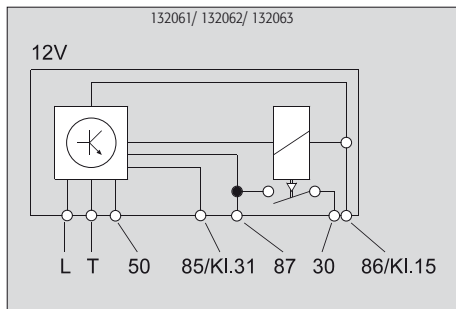

AUDI / VW
 321911261C

DELPHI
 HDC141

HELLA
 4RV008188191

HÜCO-NO.

13 2063

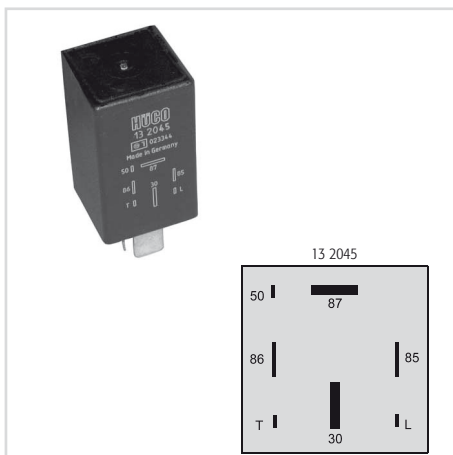

ORIGINAL- UND O.E.M.-NO.

GENERAL MOTORS
 90464952

OPEL
 6237339

HÜCO-NO.

13 2045

Glühzeitrelais Diesel Glow Plug Controllers

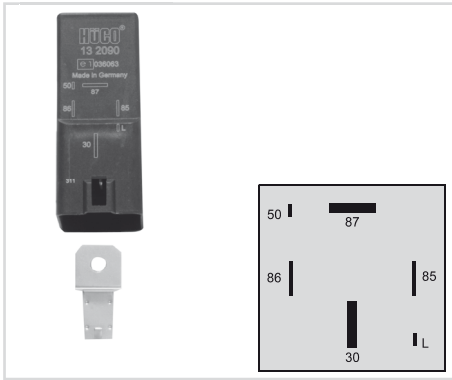

ORIGINAL- UND O.E.M.-NO.

DELPHI
HDC128
FORD
6847572 93BB6M092AA
93BB6092BA
HELLA
4RV008188401
LUCAS
HDC128

HÜCO-NO.

13 2090

mit Nachglühzeit / with post heating time



132104/132105/132106/132107/132108/132109

ORIGINAL- UND O.E.M.-NO.

BOSCH
0281003023 0281003094
VAG
038907281A

HÜCO-NO.

13 2104

in Vorbereitung /
under development

**NEU /
NEW**

Für Niederspannungskerzen mit 4,4 bzw. 5 V / For low voltage glow plugs with 4,4 or 5 V

BOSCH
281003027 281003089
VAG
038907281C

HÜCO-NO.

13 2105

in Vorbereitung /
under development

**NEU /
NEW**

Für Niederspannungskerzen mit 4,4 bzw. 5 V / For low voltage glow plugs with 4,4 or 5 V

BERU
522120504
BOSCH
281003038
VAG
038907281D
WLO
WLO51299023A

HÜCO-NO.

13 2106

in Vorbereitung /
under development

**NEU /
NEW**

Für Niederspannungskerzen mit 4,4 bzw. 5 V / For low voltage glow plugs with 4,4 or 5 V

BERU
522120505
VAG
03G907282A

HÜCO-NO.

13 2107

in Vorbereitung /
under development

**NEU /
NEW**

Für Niederspannungskerzen mit 4,4 bzw. 5 V / For low voltage glow plugs with 4,4 or 5 V

STRIBEL
899095000 899097000
VAG
03L907281

HÜCO-NO.

13 2108

in Vorbereitung /
under development

**NEU /
NEW**

Für Niederspannungskerzen mit 4,4 bzw. 5 V / For low voltage glow plugs with 4,4 or 5 V

BOSCH
281003024
IVECO
504013085

HÜCO-NO.

13 2109

in Vorbereitung /
under development

**NEU /
NEW**

Für Niederspannungskerzen mit 4,4 bzw. 5 V / For low voltage glow plugs with 4,4 or 5 V

Glühzeitrelais Diesel Glow Plug Controllers

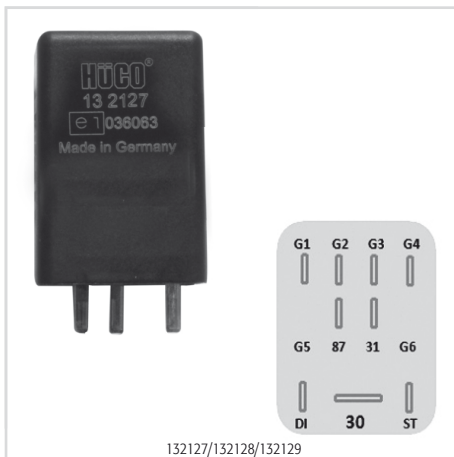

VAG
03L907282

Für Niederspannungskerzen mit 4,4 bzw. 5 V / For low voltage glow plugs with 4,4 or 5 V

BERU
0522120702
VAG
03G907282
VW
03G907282

Für Niederspannungskerzen mit 4,4 bzw. 5 V / For low voltage glow plugs with 4,4 or 5 V

BERU
0522120503
BOSCH
0281003085
VAG
038907281B
VW
038907281B

Für Niederspannungskerzen mit 4,4 bzw. 5 V / For low voltage glow plugs with 4,4 or 5 V

HÜCO-NO.
13 2127
in Vorbereitung /
under development

**NEU /
NEW**

HÜCO-NO.
13 2128
in Vorbereitung /
under development

**NEU /
NEW**

HÜCO-NO.
13 2129
in Vorbereitung /
under development

**NEU /
NEW**



ORIGINAL- UND O.E.M.-NO.

HÜCO-NO.

ALFA ROMEO			
9619039780	9639912580		
ALLIS			
9619039780	9639912580		
CARTIER			
51299011A	51299037		
CITROEN			
598143			
CITROËN			
598131	598138		
FIAT			
1348881080	9619039780	9639912580	
HELLA			
4RV008188381			
LANCIA			
9619039780	9639912580		
NAGARES			
CEP612			
PEUGEOT			
598125	598131	598138	598143
VALEO			
245618			
WEHRLE			
51299007A			

13 2088

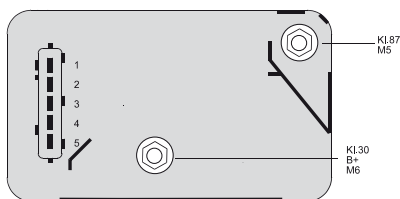

132088	1	=	Kl. 31
	2	=	n.c.
	3	=	Kl. 15
	4	=	Steuersignal In
	5	=	Steuersignal Out

Glühzeitrelais Diesel Glow Plug Controllers

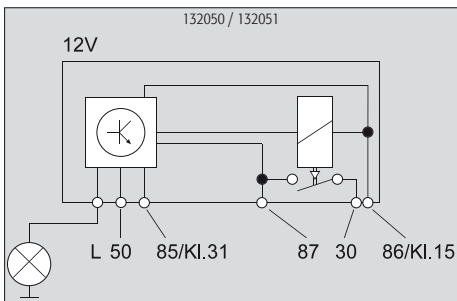
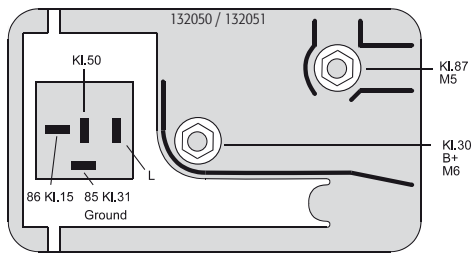

ORIGINAL- UND O.E.M.-NO.

HÜCO-NO.

BOSCH		
0333402501		
CARTIER		
2386		
CITROËN		
9549299580	95534787	
DELPHI		
HDC101		
FERRARI		
311609		
HELLA		
4RV008188081		
LUCAS		
HDC101		
MAGNETI MARELLI		
REP1A		
NAGARES		
TPD1212		
PARIS-RHONE		
102180M	105857	
PEUGEOT		
598110	598113	7920076593
9250883280	9250888280	
ROVER		
PRC5020		
SEIM		
587900		
VALEO		
245600	73100122	73101002

BOSCH		
0250201952	0333402517	0333402524
CARTIER		
2394		
CITROËN		
598115	91515869	9151586980
92515867	92515869	
DELPHI		
HDC102	HDC120	
FIAT		
5990986	4792112	5990986
HELLA		
4RV008188091		
IVECO		
4792112	9462703	
LUCAS		
HDC102	HDC120	
MAGIRUS-DEUTZ		
4792112		
NAGARES		
TPD512		
PARIS-RHONE		
102696		
PEUGEOT		
598111	598115	9151586980
9251586780	9251586980	
SEAT		
0581CR01	0581CR1	
SEIM		
6421900		
TALBOT		
598111	9121586980	9151586980
9251586780	9251586980	B515867
VALEO		
102696	245603	73103402
73105002		

HÜCO-NO.

13 2051

Glühzeitrelais Diesel Glow Plug Controllers

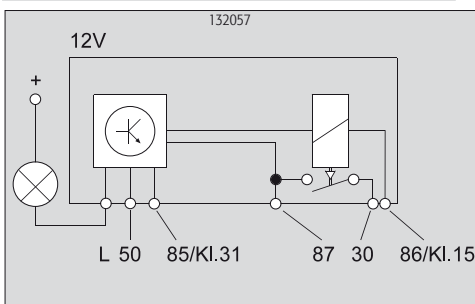
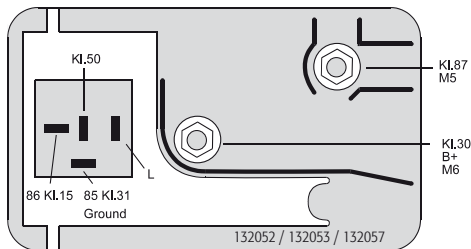
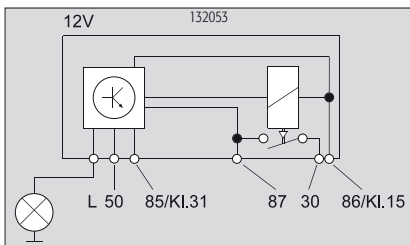
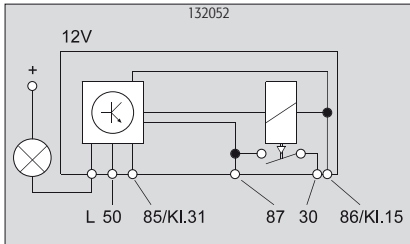

ORIGINAL- UND O.E.M.-NO.

HÜCO-NO.

AGRIA			
44360			
BOSCH			
0333402001	0333402513	0333402524	
CARTIER			
2393			
DELPHI			
HDC103			
HELLA			
4RV008188101			
LUCAS			
DSC03	HDC103		
NAGARES			
TPD612			
RENAULT			
7700702747	7700751089	7700757776	
7702089784			
SAME			
871074			
SEIM			
8110900			
VALEO			
245604	73104822		

HÜCO-NO.

DELPHI			
HDC122			
FIAT			
46428175	5973754	59737540	
75896560	7664763	76647630	
7726125			
HELLA			
4RV008188111			
LUCAS			
DSC22	HDC122		

mit Nachglühzeit / with post heating time

ORIGINAL- UND O.E.M.-NO.

HÜCO-NO.

BOSCH	
0333402525	

13 2057

mit Nachglühzeit / with post heating time

Glühzeitrelais Diesel Glow Plug Controllers



ORIGINAL- UND O.E.M.-NO.

HÜCO-NO.

CITROËN		
598116	598120	96117510
DELPHI		
HDC142		
HELLA		
4RV008188271		
RENAULT		
9611751080	9617240680	
VALEO		
245609	245612	73104902
73506302		

13 2080

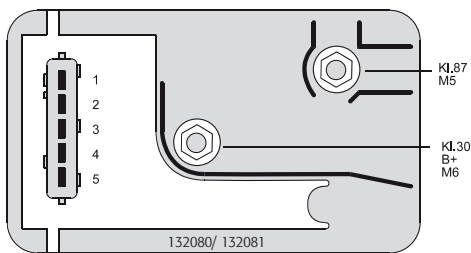

132080	1 = 85/Kl. 31
	2 = n.c.
	3 = 86/Kl. 15
	4 = Kl. 50
	5 = L/Lampe

HÜCO-NO.

13 2081

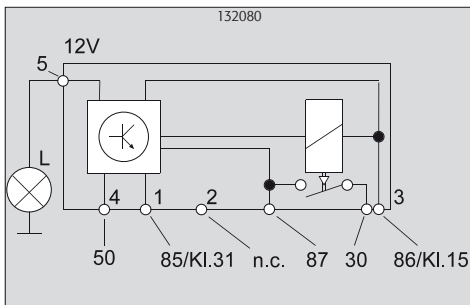

BOSCH		
0281003005	0333402501	0333402509
Citroen		
598119		
CITROËN		
598119	96141677	96252036
DELPHI		
HDC130		
FIAT		
961416778	9614167780	
HELLA		
4RV008188281		
NAGARES		
PPX512		
PEUGEOT		
598119	96141677	96252036
9625203680		
TALBOT		
9614167780		

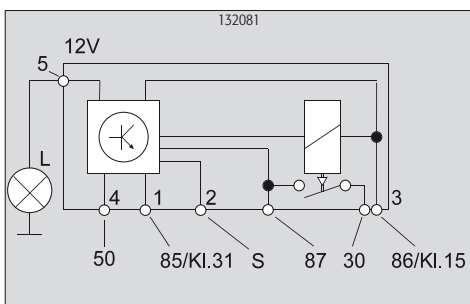

132081	1 = 85/Kl. 31
	2 = S
	3 = 86/Kl. 15
	4 = Kl. 50
	5 = L/Lampe

mit Nachglühzeit / with post heating time

Glühzeitrelais Diesel Glow Plug Controllers



ORIGINAL- UND O.E.M.-NO.

HÜCO-NO.

DELPHI
HDC136
FIAT
46414088 46438456 7735921
HELLA
4RV008188291
LANCIA
46438456

13 2082

mit Nachglühzeit / with post heating time

HÜCO-NO.

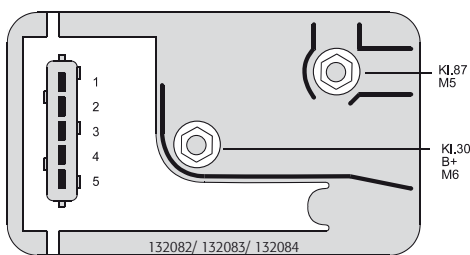

BOSCH
0281003006 0281003012
Citroen
598124
CITROËN
598124 96165824
DELPHI
HDC126
FIAT
961595948
HELLA
4RV008188301
LUCAS
HDC126 R04090002C R0409002C
PEUGEOT
598124 96165824

13 2083

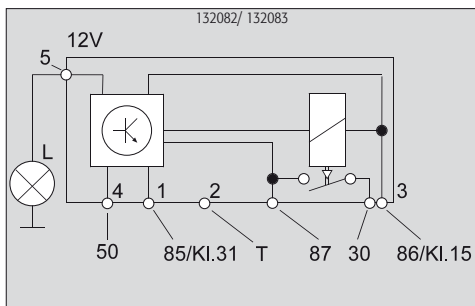

132082/ 132083	1 = 85/K1.31
	2 = T/NTC
	3 = 86/K1.15
	4 = Kl. 50
	5 = L/Lampe

mit Nachglühzeit / with post heating time

HÜCO-NO.

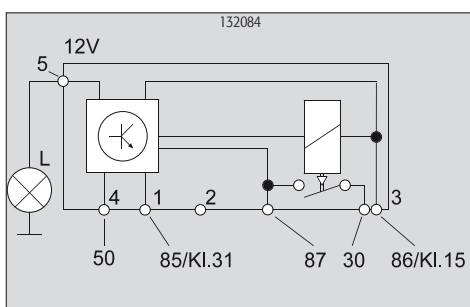

DELPHI
HDC137
FIAT
43423043 46423043
HELLA
4RV008188311

13 2084

132084	1 = 85/K1.31
	2 = n.c.
	3 = 86/K1.15
	4 = Kl. 50
	5 = L/Lampe

Glühzeitrelais Diesel Glow Plug Controllers

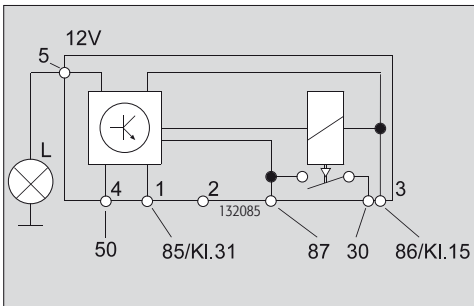
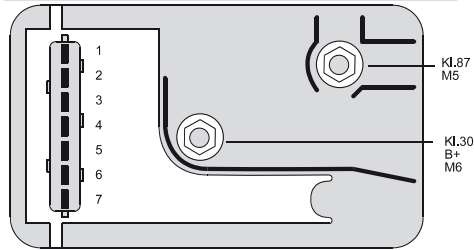

ORIGINAL- UND O.E.M.-NO.

HÜCO-NO.

BOSCH		
0281003009		
CITROËN		
598121	598126	598127
9616280080	9616582380	
DELPHI		
HDC125		
FIAT		
46423043	9615938380	
HELLA		
4RV008188321		
LUCAS		
HDC125	R04090001B	R04090001D
PEUGEOT		
598121	598126	598127
9616280080		
ROVER		
NCJ100110		

13 2085

132085	1 = 85/Kl. 31
	2 = T/NTC
	3 = 86/Kl. 15
	4 = Kl. 50
	5 = L/Lamp
	6 = n.c.
	7 = S Nachglühunterbrechung

mit Nachglühzeit / with post heating time

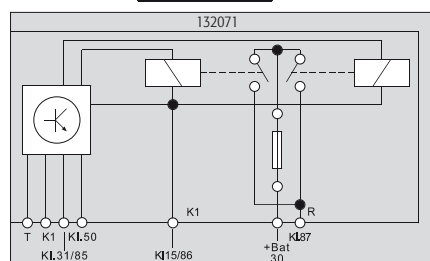
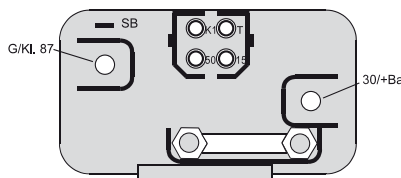

ORIGINAL- UND O.E.M.-NO.

HÜCO-NO.

DELPHI	
HDC114	
HELLA	
4RP008188331	4RV008188331
LUCAS	
DSC14	HDC114
VOLVO	
1363438	9162987

13 2071

132071	15 = 86/Kl. 15
	50 = Kl. 50
	T = T/NTC
	K1 = K/LAMPE
	SB = 85/Kl. 31
	G = Kl. 87

mit Nachglühzeit / with post heating time

Glühzeitrelais Diesel Glow Plug Controllers

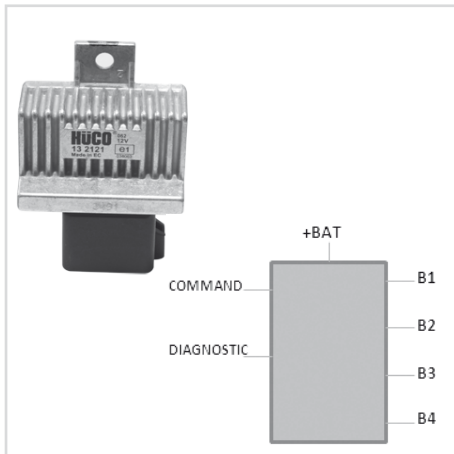

ORIGINAL- UND O.E.M.-NO.

HÜCO-NO.

GM
 91167210 9201699
NAGARES
 BED712
OPEL
 4409990 4506156
RENAULT
 7700115078

13 2121

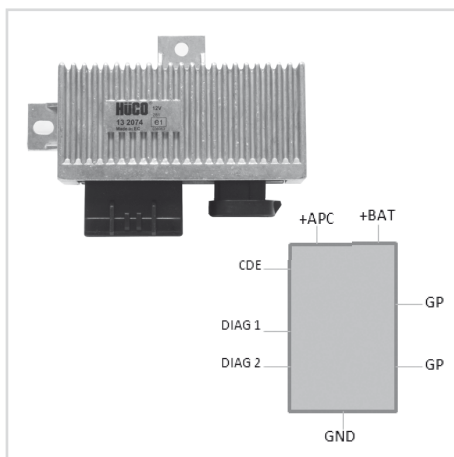

ORIGINAL- UND O.E.M.-NO.

HÜCO-NO.

GM
 9110721 9110721
NAGARES
 BRE312 BRE612
OPEL
 4402721
RENAULT
 7700100703 7700111525

13 2074

mit Nachglühzeit / with post heating time

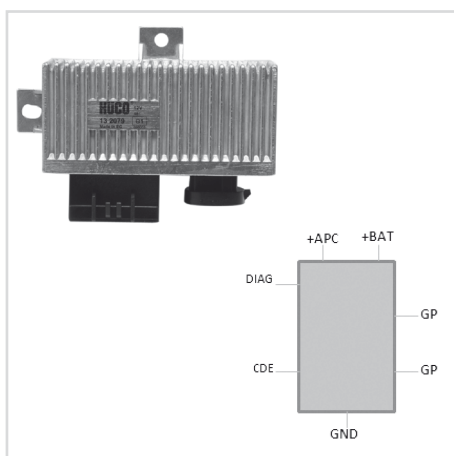

ORIGINAL- UND O.E.M.-NO.

HÜCO-NO.

GM
 9108385 9108385
NAGARES
 BRE512
OPEL
 4400385
RENAULT
 7700109860

13 2079

mit Nachglühzeit / with post heating time

Glühzeitrelais Diesel Glow Plug Controllers

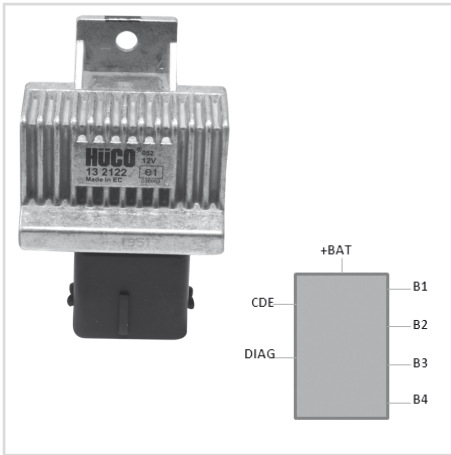

ORIGINAL- UND O.E.M.-NO.

HÜCO-NO.

CITROEN
9640469680 9640469680A
GM
93858431
NAGARES
BDL712
OPEL
4416764
PEUGEOT
9640469680 9640469680A

13 2122

**NEU /
NEW**

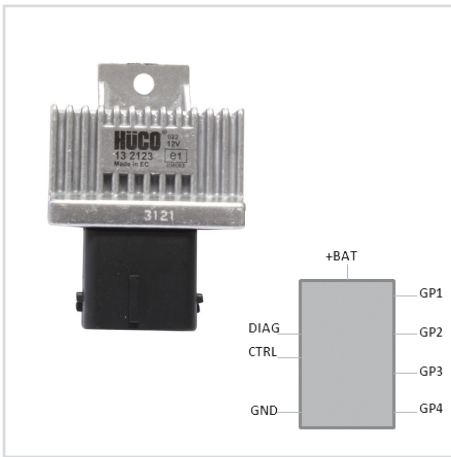

ORIGINAL- UND O.E.M.-NO.

HÜCO-NO.

GM
93862497
NISSAN
11067JD50C
OPEL
2523080A0A 4419200
RENAULT
8200859243

13 2123

**NEU /
NEW**



ORIGINAL- UND O.E.M.-NO.

HÜCO-NO.

DELPHI
HDC124
GM
9110510 9110510
HELLA
4RV008188241
LUCAS
HDC124
NAGARES
TRM1212 TRMA1212 TRMK1212
OPEL
4402510
RENAULT
7700790579 7700851443 7700863454
7700867374
VALEO
245607

13 2075

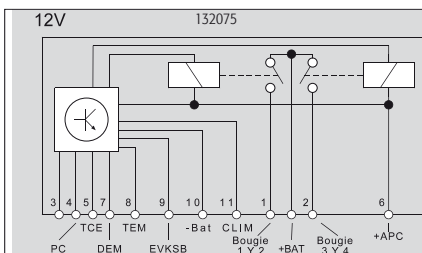
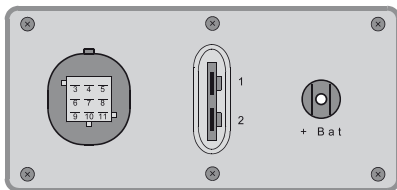

132075	+ BAT	=	Kl. 30
	1 Bougie 1Y2	=	Kl. 87
	2 Bougie 3Y4	=	Kl. 87
	3	=	n.c.
	4 PC	=	Volllastschalter
	5 TEC	=	Thermoschalter
	6 +Apc	=	86/Kl. 15
	7 DEM	=	Kl. 50
	8 TEM	=	Lampe
	9 EVKSB	=	el. Kaltstartventil
	10 - BAT	=	85/Kl. 31
	11 Clim	=	Klimaanlage

mit Nachglühzeit / with post heating time

Glühzeitrelais Diesel Glow Plug Controllers



ORIGINAL- UND O.E.M.-NO.

STRIBEL
899063000
VW
2D0911253

HÜCO-NO.

13 2165

**NEU /
NEW**

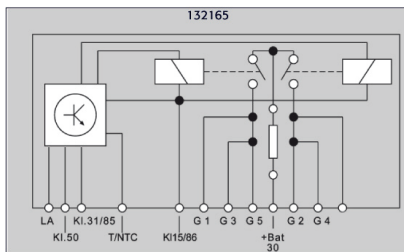
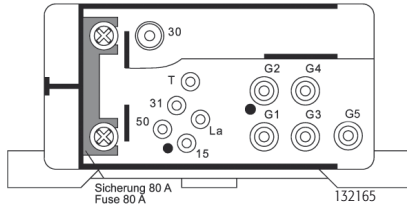

ORIGINAL- UND O.E.M.-NO.

BOSCH
0333402505 0333402506
DELPHI
HDC116
HELLA
4RV008188001
KÄSSBOHRER
73751591000
LUCAS
HDC116
MERCEDES-BENZ
0015459732 0025450532 0025450832
55454132 A0015459732
A0025450532

HÜCO-NO.

13 2030

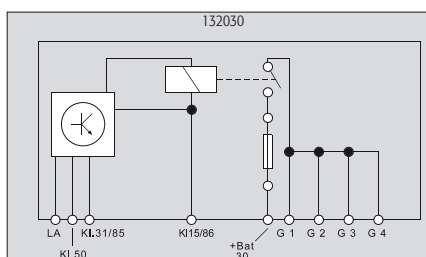
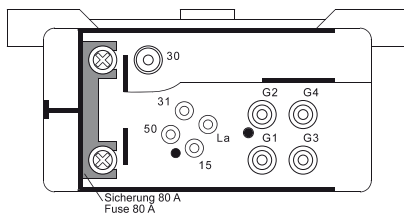

Glühzeitrelais Diesel Glow Plug Controllers

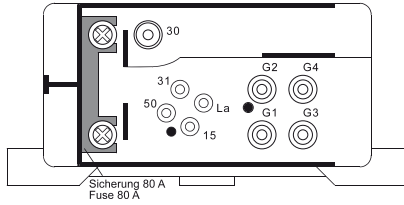

132031

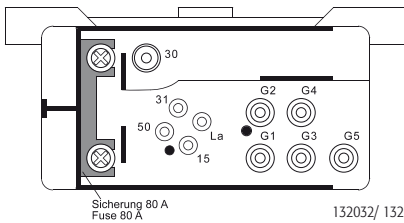
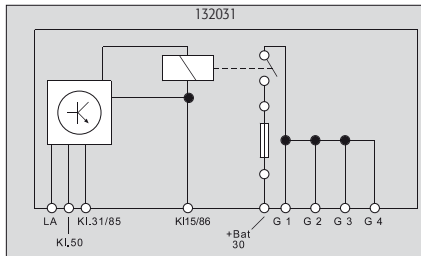

132032/ 132038

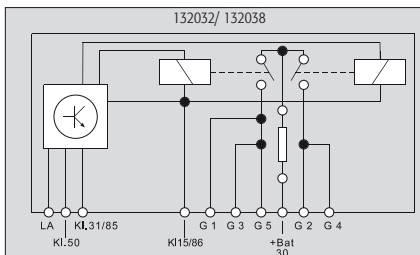

ORIGINAL- UND O.E.M.-NO.

BOSCH			
0333402515	0333402516		
DELPHI			
HDC118			
HELLA			
4RV008188011			
LUCAS			
HDC118			
MERCEDES-BENZ			
0025454232	0025454332	A0025454232	
A0025454332			

HÜCO-NO.

13 2031

ORIGINAL- UND O.E.M.-NO.

BOSCH			
0333402507	0333402508		
DELPHI			
HDC117			
HELLA			
4RV008188021			
KÄSSBOHRER			
737515000	7375155000		
LUCAS			
HDC117			
MERCEDES-BENZ			
0015450532	0015459832	0025450632	
25450932	A0015450532	A0015459832	
A0025450632	A0025450932		

HÜCO-NO.

13 2032

BOSCH			
0281003096	0333402505	0333402507	
0333402515			
DELPHI			
HDC134			
HELLA			
4RV008188371			
MERCEDES-BENZ			
00255455432	A0255455432		

HÜCO-NO.

13 2038

Austausch in Verbindung mit nachglühfähigen Glühkerzen
Exchange in connection with post heating glow plugs

BOSCH	HÜCO	BOSCH	HÜCO
0333402505	13 2030	>>>	0281003096
0333402507	13 2032	>>>	0281003096
			13 2038

mit Nachglühzeit / with post heating time

Glühzeitrelais Diesel Glow Plug Controllers



ORIGINAL- UND O.E.M.-NO.

HÜCO-NO.

HELLA
4RV008188031
LUCAS
HDC115
MERCEDES-BENZ
0035452532 0055454532 A0035452532
A0055454532

13 2033

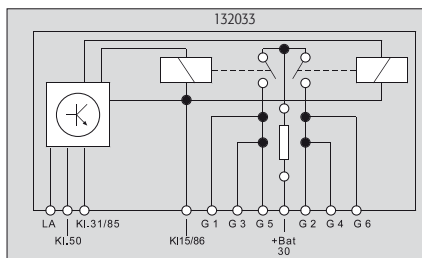
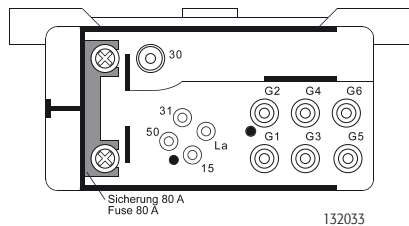

ORIGINAL- UND O.E.M.-NO.

HÜCO-NO.

DELPHI
HDC131
HELLA
4RV008188041
MERCEDES-BENZ
0065458932 0075459832 A0065458932
A0075459832

13 2034

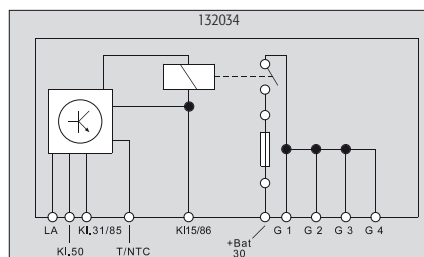
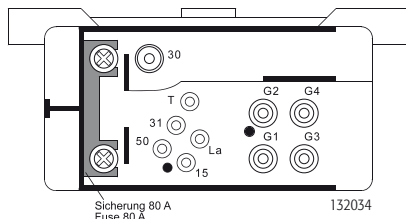

mit Nachglühzeit / with post heating time

Glühzeitrelais Diesel Glow Plug Controllers



ORIGINAL- UND O.E.M.-NO.

HÜCO-NO.

DELPHI
 HDC132
HELLA
 4RV008188051
MERCEDES-BENZ
 0065458832 0085450032 A0065458832
 A0085450032

13 2035

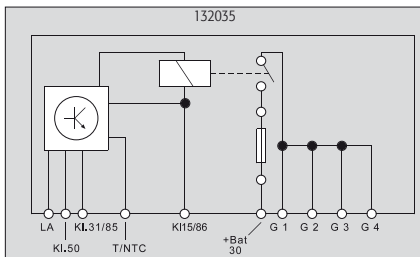
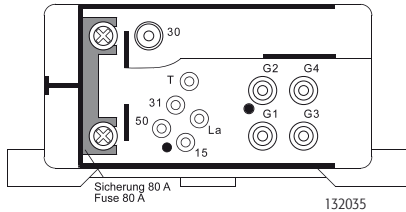

mit Nachglühzeit / with post heating time



ORIGINAL- UND O.E.M.-NO.

HÜCO-NO.

DELPHI
 HDC133
HELLA
 4RV008188061
MERCEDES-BENZ
 0055454032 0065459032 0075459932
 135452432 A0055454032 A0065459032
 A0075459932 A0135452432
SSANGYONG
 6625453032 6625453532

13 2036

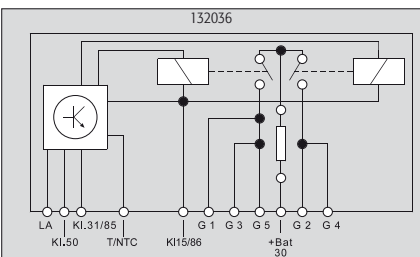
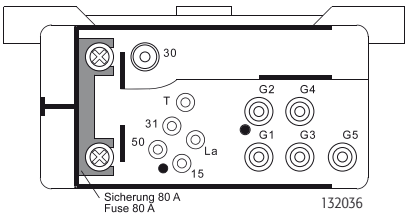

mit Nachglühzeit / with post heating time

Glühzeitrelais Diesel Glow Plug Controllers



ORIGINAL- UND O.E.M.-NO.

HÜCO-NO.

DELPHI
 HDC140
HELLA
 4RV008188071
MERCEDES-BENZ
 0075451632 0125459032 155453032
 A0075451632 A0125459032 A0155453032

13 2037

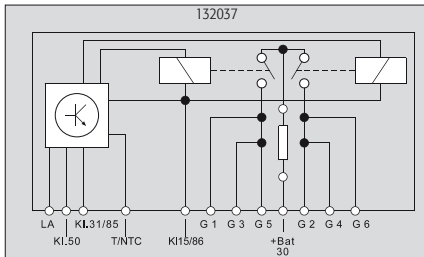
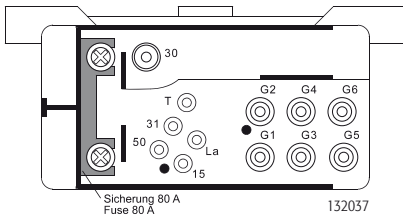

mit Nachglühzeit / with post heating time



ORIGINAL- UND O.E.M.-NO.

HÜCO-NO.

BERU
 0201010079
MERCEDES-BENZ
 0125458832 A0125458832

13 2160

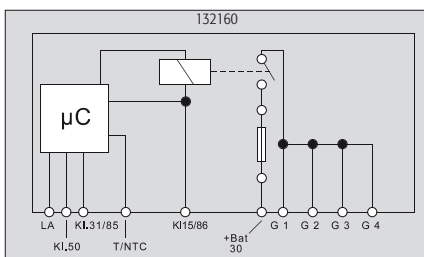
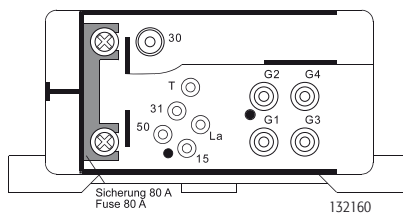

mit Nachglühzeit / with post heating time

Glühzeitrelais Diesel Glow Plug Controllers



ORIGINAL- UND O.E.M.-NO.

HÜCO-NO.

MERCEDES BENZ
0065452232

13 2164

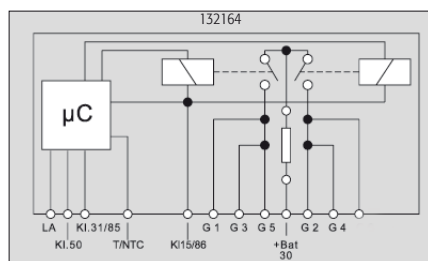
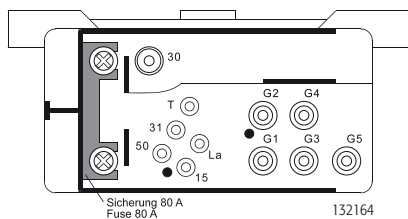

mit Nachglühzeit / with post heating time

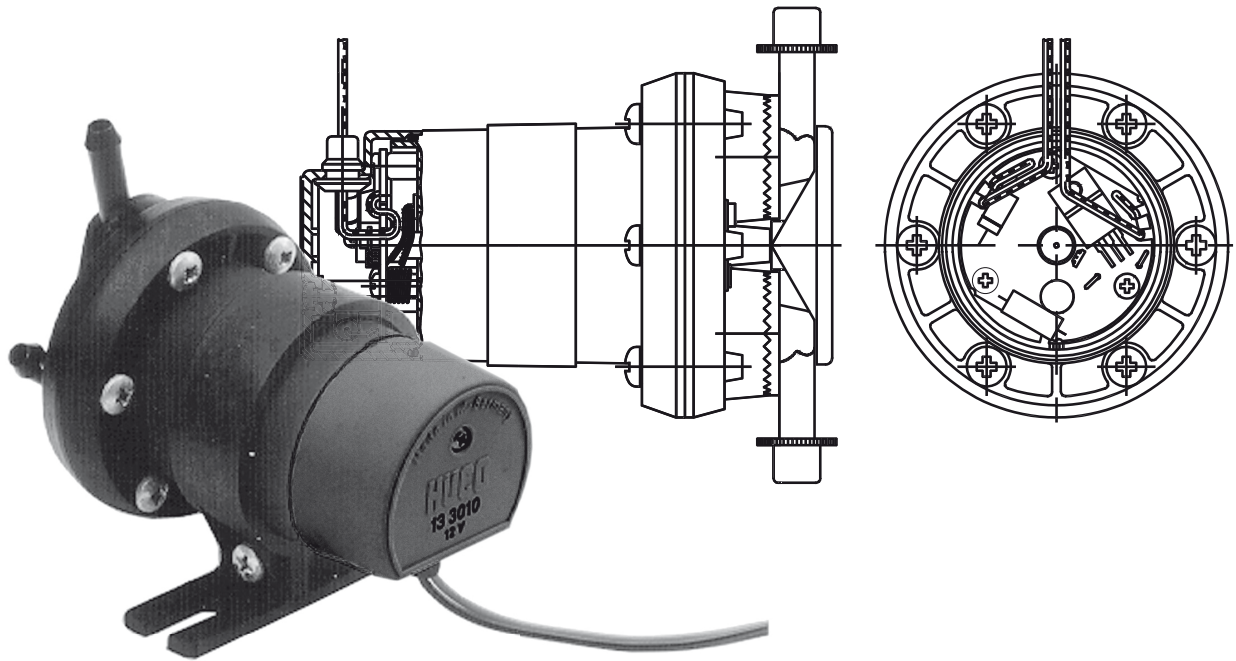

Seite/Page

Anwenderinformationen
Features and Benefits

40

Anwendungsbeispiele
Examples for Application

41

Technische Information
Technical Information

42

Die Kraftstoffpumpe
The Fuel Pump

43

Elektrische Kraftstoffpumpen
Electric Fuel Pumps

44-46

Einsatzgebiete der HÜCO Kraftstoffpumpen

- Ersatz für mechanische Förderpumpen in allen Fahrzeugen (nicht als Einspritzpumpe, Einbau im Motorraum)
- Ersatz für elektrische Förderpumpen in allen Fahrzeugen (nicht als Einspritzpumpe, Einbau in Tanknähe) für Zusatzheizungen und Kühlanlagen.
Bei besonderen Umweltbedingungen
 - a) Wenn Kraftstoffe mit Alkoholzusatz verwendet werden
 - b) In warmen Ländern, wenn der Kraftstoff zur Blasenbildung neigt
 - c) In Hochländern (über 1000 m)
- Für industrielle Anwendungen zur Förderung unterschiedlicher flüssiger Stoffe
 - a) Ottomotor-Kraftstoffe: Super, Normal
 - b) Mischkraftstoffe: Methanol, Äthanol
 - c) Diesekraftstoff

Vorteile der HÜCO Kraftstoffpumpen

- Die Pumpe fördert nur soviel Kraftstoff wie benötigt wird und schaltet ab wenn kein Bedarf besteht. (Energieeinsparung)
- Die Pumpe kann Kraftstoff selbst ansaugen und muss deshalb nicht unterhalb des Tanks angeordnet werden.
- Lange Lebensdauer, da keine Verschleißteile
- Konstante Funktionssicherheit über Jahre
- Geringe Laufgeräusche
- Große Leistung
- Geringes Gewicht
- Die Pumpe ist korrosionsbeständig
- Die Pumpe ist beständig gegen Methanol- und Äthanolkraftstoffe
- Die Pumpe schaltet elektronisch und verursacht keine Funkstörung

Montagehinweise:

- Prüfen Sie, ob Sie die richtige Pumpe haben:
Saugpumpe - für die Montage im Motorraum, jedoch nicht im Bereich der Motorstrahlungswärme
Druckpumpe - für Montage in Tanknähe
- Einbaulage beliebig
- Auf richtige Polarität achten:
Rotes Kabel = (+) Schwarzes Kabel = (-)
- Bei Einsatz der elektrischen Kraftstoffpumpe in Fahrzeugen mit Vergasermotor ist eine Sicherheitsabschaltung zu verwenden. Die Sicherheitsabschaltung schaltet die elektrische Kraftstoffförderpumpe ab, wenn bei einem Unfall des Fahrzeuges der Motor bei eingeschalteter Zündung zum Stehen kommt. Eine Sicherheitsabschaltung ist im Handel erhältlich, z.B. Benzinpumpenrelais 132000, 132001, 132020 der Fa. HÜCO

Applications for HÜCO fuel pumps

- To replace mechanical pumps in all vehicles (except for injection pumps, fitted near the engine)
- To replace electrical pumps in all vehicles (except for injection pumps, fitted near the fuel tank)
- In additional heater and cooling systems under certain environmental conditions
 - a) when alcohol/ fuel compounds are utilized
 - b) in hot regions where fuel easily evaporates
 - c) in regions located above 1.000 m
- For industrial applications whenever liquid has to be delivered
 - a) Ottomotor-fuels: premium gas, regular gas
 - b) mixed-fuels: methanol, ethanol
 - c) Diesel fuel

Advantages of the HÜCO fuel pumps

- The pump is self-priming and stops when no fuel is needed (energy saving)
- Needs not necessarily be fitted below the tank (self-priming)
- Extended working life since the pump is not affected by wear and tear
- Perfect functioning over many years
- Low operating noise
- High performance
- Low weight
- The pump is corrosion- proof
- The pump is resistant to methanol and ethanol
- The pump is switched electronically and excludes any radio interference

Fitting Instructions:

- Check whether you have the correct pump:
Suction Pump - for mounting in engine compartment, however not in the area of engine radiant heat
Pressure Pump - for mounting near the tank
- Optional fitting position
- Pay attention to the correct polarity:
Red cable = (+) Black cable = (-)
- When mounting the electrical fuel pump into vehicles with carburettor motors a safety switch has to be used. When the engine of the vehicle comes to a stop in case of an accident and the ignition is still switched-on, the safety switch cuts-off the electrical fuel pump. A safety switch is available on the market, i. e. fuel pump relais 132000, 132001, 132020 from HÜCO

Anwendungsbeispiele Examples for Application

Der besondere **Vorteil** der elektrischen **HÜCO Kraftstoffpumpen** liegt darin, dass damit mechanische und elektrische Förderpumpen ersetzt werden können (ausgenommen Einspritzpumpen).

Einsatz von Pumpen unter erschwerten Bedingungen oder mit größerem Fördervolumen, z.B. im LKW, Landmaschinen, zur Versorgung von Kühlanlagen, Zusatzheizungen in Booten, Stromaggregaten etc.

Bei der Auswahl der richtigen Pumpe sollte folgendes Prinzip angewandt werden:

The particular **advantage** of the **HÜCO Fuel Pumps** is due to the fact that they can replace mechanic and electric fuel pumps (except injection pumps).

Application of pumps under difficult conditions or for higher outputs, e. g. in lorries, agricultural machines, for supply of cooling systems, additional heaters, in boats, generating units etc.

The following principle should be used when choosing the suitable pump:

Auswahlkriterien Type of Installation		Art der Pumpe Kind of Pump	Typ Type
PKW CAR	Ersatz einer mechanischen/elektrischen Pumpe – Einbau im Motorraum replacement of a mechanic/an electric pump – installation in the motor compartment	Saugpumpe 14 V Suction pump 14 V	13 3010
LKW TRUCK	Ersatz einer mechanischen/elektrischen Pumpe – Einbau im Motorraum replacement of a mechanic/an electric pump – installation in the motor compartment	Saugpumpe 28 V Suction pump 28 V	13 3040
PKW CAR	Ersatz einer elektrischen Pumpe – Einbau in Tanknähe replacement of an electric pump – installation near the tank	Druckpumpe 14 V Pressure pump 14 V	13 3000 13 3008
LKW TRUCK	Ersatz einer elektrischen Pumpe – Einbau in Tanknähe replacement of an electric pump – installation near the tank	Druckpumpe 28 V Pressure pump 28 V	13 3030 13 3038

Förderkurve für:
 Delivery curve for:

Druckpumpen
 pressure pumps

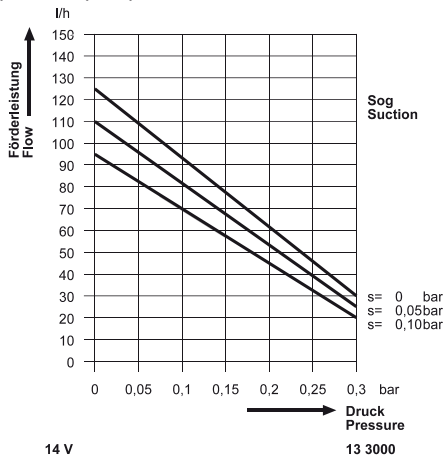

Saugpumpen
 suction pumps

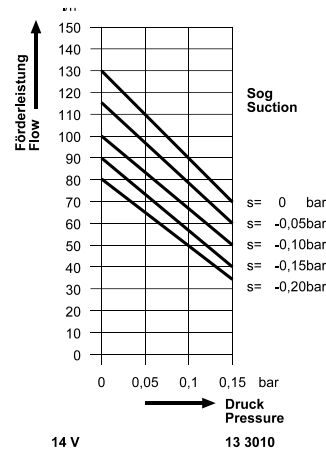

Förderkurve für:
 Delivery curve for:

Druckpumpen 28V
 pressure pumps 28V

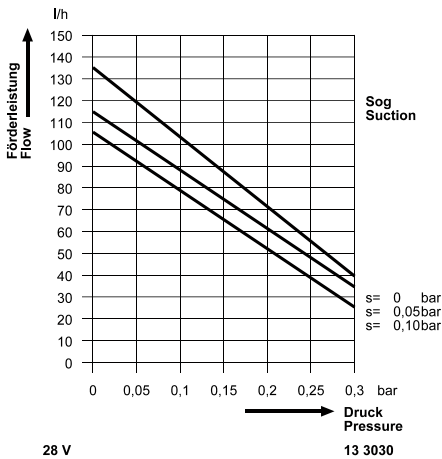

Saugpumpen 28V
 suction pumps 28V

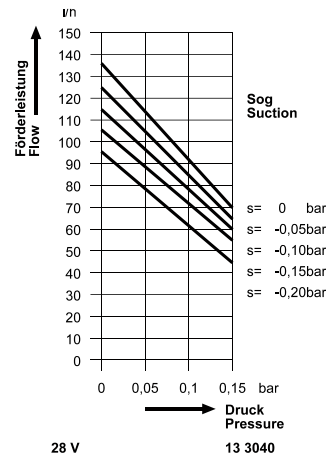

Beispiel für die Ermittlung der
 Förderleistung

Einbauverhältnisse:

Die Pumpe ist ca. 0,7 m oberhalb des Tanks montiert und muß den Kraftstoff ca. 1,3 m hoch in den Vergaser pumpen.

Saughöhe:

= 0,7 m Benzin $\hat{=}$ -0,05 bar

Druckhöhe:

= 1,3 m Benzin $\hat{=}$ 0,10 bar

How to find out the pump's
 delivery capacity

Fitting features:

The pump is fitted approx. 1.3 m below the carburettor and approx. 0,7 m above the tank.

Suction head:

= 0,7 m fuel $\hat{=}$ -0,05 bar

Pressure head:

= 1,3 m fuel $\hat{=}$ 0,10 bar

Verwendete Pumpe:

Druckpumpe 13 3000 / 13 3008

Wir verfolgen die Kennlinie SOG-0,05 bar bis auf eine Druckhöhe von 0,10 bar und können am Schnittpunkt links die Literleistung von 80 l pro Stunde ablesen.

Operating pump:

pressure pump 13 3000 / 13 3008

Follow the curve SUCTION-0.05 bar up to 0,10 bar (= pressure head); you will then find the pump's throughput on the axis left, which is 80 liters/h in the example.

Die Kraftstoffpumpe The Fuel Pump

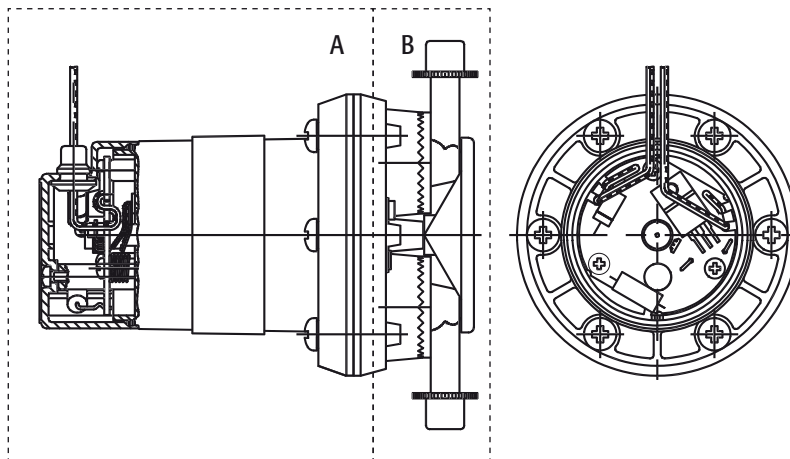

Merkmale

Die **HÜCO** Kraftstoffpumpe ist eine Membranpumpe!
Sie besteht im wesentlichen aus 2 Hauptgruppen:

- a) **Antriebseinheit**
Elektromagnet mit Steuereinheit
- b) **Ventileinheit**
Ventilgehäuse mit Druckventil, Saugventil und Membrane

Arbeitsweise

Bei eingeschalteter Zündung erhält die elektrische Kraftstoffpumpe Spannung und der Elektromagnet zieht die Membrane an. Somit wird Kraftstoff durch das Saugventil in das Ventilgehäuse gesaugt. Die unter der Schutzkappe befindliche Steuereinheit schaltet nun den Strom für die Spule des Elektromagneten ab, und eine hinter der Membrane angeordnete Feder drückt die Membrane zurück. Jetzt wird der Kraftstoff durch das Druckventil herausgedrückt. Die Steuereinheit schaltet nun den Elektromagneten wieder ein, und der Vorgang wiederholt sich.

Wartung und Verschleiß

Die **HÜCO** Kraftstoffpumpe ist wartungs- und nahezu verschleißfrei.

General Remarks

The **HÜCO** Fuel Pump is a so-called diaphragm pump!
The main parts are:

- a) **Drive assembly**
Solenoid with control circuit
- b) **Valve assembly**
Valve housing with pressure valve, suction valve and diaphragm

Function

As soon as the ignition switch is in 'on'-position, voltage is supplied and the plunger of solenoid moves upwards and, consequently, fuel is sucked into the valve housing. While the plunger moves upwards, it triggers a sensorcontact and the current flows through the coil of solenoid will be cut. A spring mounted beneath the diaphragm will now push the diaphragm in its starting position and the fuel is being pushed through the pressure valve. By reaching the initial position the plunger triggers the sensorcontact and the whole workcycle starts over again.

Service and Abrasion

The **HÜCO** Fuel Pump is maintenance-free and almost without abrasion.

Druck- Umrechnungstabelle / Pressure-Conversion table

bar	$\frac{KP}{cm^2}$	AT	TORR	Wassersäule (m) column of water	Benzinsäule (m) column of fuel	Dieselsäule (m) column of Diesel	PSI $\left(\frac{lbs}{Sq. inch}\right)$
0,30	0,30	0,30	225	3,0	4,0	3,4	4,3
0,25	0,25	0,25	187	2,5	3,3	2,8	3,6
0,20	0,20	0,20	150	2,0	2,7	2,2	2,9
0,15	0,15	0,15	112	1,5	2,0	1,7	2,2
0,10	0,10	0,10	75	1,0	1,3	1,1	1,4
0,05	0,05	0,05	37	0,5	0,7	0,6	0,7

Menge- Umrechnungstabelle / Flow-Conversion table

Liter/h	gal/h (US)	gal/h (UK)	Wasser (lbs/h) water (lbs/h)	Benzin (lbs/h) fuel (lbs/h)	Diesel (lbs/h) Diesel fuel (lbs/h)
120	32	26	265	201	239
100	26	22	221	168	199
80	21	17	177	134	159
60	16	13	132	101	120
40	10	9	88	67	80
20	5	4	44	33	40



TECHNISCHE DATEN/ TECHNICAL DATA

HÜCO-NO.

13 3000

Druckpumpe 14 V

geeignet zur Montage in Tanknähe

Förderleistung (l/h): 125
Druckhöhe (Bar): 0,30
Saughöhe (Bar): -0,10
Kraftstoffanschluß: 2 Schlauchanschlüsse
Ø 8 mm, schwenkbar
ca. 220°

Befestigung: mittels Halterung
Abmessungen: 73 x 128 mm
Gewicht: 820 g

Pressure Pump 14 V

fitted near the tank

Fuel delivery capacity (l/h): 125
Pressure head (Bar): 0,30
Suction head (Bar): -0,10
Fuel terminal: 2 tube terminals Ø 8 mm,
approx 220° turnable

Fixing: with bracket
Dimensions: 73 x 128 mm
Weight: 820 g



TECHNISCHE DATEN/ TECHNICAL DATA

HÜCO-NO.

13 3008

Druckpumpe 14 V

wie 13 3000 jedoch

Spezial Pumpe:

Verbindung zwischen Membrane und Antrieb aus Edelstahl.

Geeignet für: Wasser, dünnflüssige und wasserlösliche Flüssigkeiten,
Aromastoffe usw.

Pressure Pump 14 V

as 13 3000 but

Special pump:

Connection between mebrane and drive made of high-grade steel.

Suitable for: Water, thin and water-soluble liquids, flavour substances etc.



HÜCO-NO.

13 3001

Montagehalterung

als Ersatz für Pumpen

13 3000, 13 3008, 13 3010, 13 3030, 13 3038, 13 3040
VPE 1ST.

Mounting holder

as replacement for pumps

13 3000, 13 3008, 13 3010, 13 3030, 13 3038, 13 3040
packing unit 1pce.



TECHNISCHE DATEN/ TECHNICAL DATA

HÜCO-NO.

13 3010

Saugpumpe 14 V

geeignet zur Montage im Motorraum

Förderleistung (l/h): 130
Druckhöhe (Bar): 0,15
Saughöhe (Bar): -0,20
Kraftstoffanschluß: 2 Schlauchanschlüsse
Ø 8 mm, schwenkbar
ca. 220°

Befestigung: mittels Halterung
Abmessungen: 73 x 128 mm
Gewicht: 820 g

Suction Pump 14 V

fitted near the engine

Fuel delivery capacity (l/h): 130
Pressure head (Bar): 0,15
Suction head (Bar): -0,20
Fuel terminal: 2 tube terminals Ø 8 mm,
approx 220° turnable
with bracket

Fixing: mittels Halterung
Dimensions: 73 x 128 mm
Weight: 820 g



TECHNISCHE DATEN/ TECHNICAL DATA

HÜCO-NO.

13 3030

Druckpumpe 28 V

geeignet zur Montage in Tanknähe

Förderleistung (l/h): 125
Druckhöhe (Bar): 0,30
Saughöhe (Bar): -0,10
Kraftstoffanschluß: 2 Schlauchanschlüsse
Ø 8 mm, schwenkbar
ca. 220°

Befestigung: mittels Halterung
Abmessungen: 73 x 128 mm
Gewicht: 800 g

Pressure Pump 28 V

fitted near the tank

Fuel delivery capacity (l/h): 125
Pressure head (Bar): 0,30
Suction head (Bar): -0,10
Fuel terminal: 2 tube terminals Ø 8 mm,
approx 220° turnable
with bracket

Fixing: mittels Halterung
Dimensions: 73 x 128 mm
Weight: 800 g



HÜCO-NO.

13 3002

Schwenkanschluß für Schläuche

als Ersatzteil für

13 3000, 13 3008, 13 3010, 13 3030, 13 3038, 13 3040
VPE 1ST.

Movable connection for hoses

as spare part for

13 3000, 13 3008, 13 3010, 13 3030, 13 3038, 13 3040
packing unit 1pce.



TECHNISCHE DATEN/ TECHNICAL DATA

HÜCO-NO.

13 3038

Druckpumpe 28 V
wie 13 3030 jedoch
Spezial Pumpe:

Verbindung zwischen Membrane und Antrieb aus Edelstahl.

Geeignet für: Wasser, dünnflüssige und wasserlösliche Flüssigkeiten,
Aromastoffe usw.

Pressure Pump 28 V
as 13 3030 but
Special pump:

Connection between diaphragm and drive made of high-grade steel.

Suitable for: Water, thin and water-soluble liquids, flavour substances etc.



TECHNISCHE DATEN/ TECHNICAL DATA

HÜCO-NO.

13 3040

Saugpumpe 28 V
geeignet zur Montage im Motorraum
Förderleistung (l/h): 135
Druckhöhe (Bar): 0,15
Saughöhe (Bar): -0,20
Kraftstoffanschluß: 2 Schlauchanschlüsse Ø 8 mm,
schwenkbar
ca. 220°

Befestigung: mittels Halterung
Abmessungen: 73 x 128 mm
Gewicht: 800 g

Suction Pump 28 V
suitable for near the engine
Fuel delivery capacity (l/h): 135
Pressure head (Bar): 0,15
Suction head (Bar): -0,20
Fuel terminal: 2 tube terminals Ø 8 mm,
approx 220° turnable
with bracket
Fixing: mittels Halterung
Dimensions: 73 x 128 mm
Weight: 800 g



Modell
Model

Motor
Engine



Baujahr
Construction year

HÜCO-NO. Seite
Page

ALFA ROMEO	145 (930) / 1.9 TD	66 kW 1698 cc	10.1994-02.1999	132084	29
ALFA ROMEO	145 (930) / 1.9 TD	66 kW 1929 cc	10.1994-02.1999	132085	30
ALFA ROMEO	146 (930) / 1.9 TD	66 kW 1905 cc	12.1994-02.1999	132084	29
ALFA ROMEO	146 (930) / 1.9 TD	66 kW 1929 cc	12.1994-02.1999	132085	30
ALFA ROMEO	75 (162B) / 1.8 Turbo i.e. (162.B1E)	114 kW 1796 cc	02.1986-01.1990	132040	18
ALFA ROMEO	75 Stufenh. 1.8 Turbo i.e.	114 kW 1779 cc	02.1986-01.1990	132040	18
AUDI	100 (43, C2) / 2.0 D	51 kW 1968 cc	08.1978-07.1982	132062	23
AUDI	100 (43, C2) / 2.0 D	51 kW 1986 cc	08.1978-07.1982	132063	23
AUDI	100 (44, 44Q, C3) / 1.8	55 kW 1781 cc	08.1982-12.1987	132021	17
AUDI	100 (44, 44Q, C3) / 1.8	55 kW 1986 cc	08.1982-12.1987	132020	16
AUDI	100 (44, 44Q, C3) / 1.8	65 kW 1781 cc	02.1986-07.1988	132021	17
AUDI	100 (44, 44Q, C3) / 1.8	65 kW 1997 cc	02.1986-07.1988	132020	16
AUDI	100 (44, 44Q, C3) / 1.8	66 kW 1781 cc	08.1983-07.1989	132020	16
AUDI	100 (44, 44Q, C3) / 1.8	66 kW 1781 cc	08.1983-07.1989	132021	17
AUDI	100 (44, 44Q, C3) / 1.8 quat.	65 kW 1781 cc	08.1986-07.1990	132021	17
AUDI	100 (44, 44Q, C3) / 1.8 quat.	65 kW 2144 cc	08.1986-07.1990	132020	16
AUDI	100 (44, 44Q, C3) / 1.8 quat.	66 kW 1781 cc	10.1984-07.1988	132020	16
AUDI	100 (44, 44Q, C3) / 2.0	83 kW 1422 cc	08.1986-11.1987	132021	17
AUDI	100 (44, 44Q, C3) / 2.0 D	51 kW 1905 cc	08.1982-07.1988	132061	23
AUDI	100 (44, 44Q, C3) / 2.0 D	51 kW 1986 cc	08.1982-07.1988	132062	23
AUDI	100 (44, 44Q, C3) / 2.0 D	51 kW 1986 cc	08.1982-07.1988	132063	23
AUDI	100 (44, 44Q, C3) / 2.0 D Turbo	64 kW 1986 cc	08.1982-02.1988	132061	23
AUDI	100 (44, 44Q, C3) / 2.0 D Turbo	64 kW 1986 cc	08.1982-02.1988	132062	23
AUDI	100 (44, 44Q, C3) / 2.0 D Turbo	64 kW 1986 cc	08.1982-02.1988	132063	23
AUDI	100 (44, 44Q, C3) / 2.0 D Turbo	74 kW 1986 cc	03.1988-11.1990	132062	23
AUDI	100 (44, 44Q, C3) / 2.0 D Turbo	74 kW 1986 cc	03.1988-11.1990	132063	23
AUDI	100 (44, 44Q, C3) / 2.0 D Turbo	74 kW 1986 cc (NC)	03.1988-11.1990	132061	23
AUDI	100 (44, 44Q, C3) / 2.4 D	60 kW 2370 cc	08.1989-07.1991	132062	23
AUDI	100 (44, 44Q, C3) / 2.4 D	60 kW 2370 cc	08.1989-07.1991	132063	23
AUDI	100 (44, 44Q, C3) / 2.4 D	60 kW 2497 cc	08.1989-07.1991	132061	23
AUDI	100 (44, 44Q, C3) / 2.5 TDI	88 kW 1986 cc	01.1990-11.1990	132061	23
AUDI	100 (4A, C4) / 2.4 D	60 kW 2370 cc (AAS)	12.1990-06.1994	132061	23
AUDI	100 (4A, C4) / 2.5 TDI	85 kW 2461 cc (AAT)	12.1990-06.1994	132061	23
AUDI	100 Avant / 1.8 quat. KAT	66 kW 1598 cc	08.1985-10.1990	132020	16
AUDI	100 Avant (43, C2) / 2.0 D	51 kW 1986 cc	08.1978-02.1983	132063	23
AUDI	100 Avant (43, C2) / 2.0 D	51 kW 2497 cc	08.1978-02.1983	132062	23
AUDI	100 Avant (44, 44Q, C3) / 1.8	55 kW 1781 cc	08.1982-12.1987	132021	17
AUDI	100 Avant (44, 44Q, C3) / 1.8	55 kW 1994 cc	08.1982-12.1987	132020	16
AUDI	100 Avant (44, 44Q, C3) / 1.8	66 kW 1781 cc	08.1983-07.1989	132021	17
AUDI	100 Avant (44, 44Q, C3) / 1.8	66 kW 1997 cc	08.1983-07.1989	132020	16
AUDI	100 Avant (44, 44Q, C3) / 1.8 quat.	66 kW 1781 cc	10.1984-07.1988	132020	16
AUDI	100 Avant (44, 44Q, C3) / 2.0 D	51 kW 1986 cc	03.1983-11.1990	132063	23
AUDI	100 Avant (44, 44Q, C3) / 2.0 D	51 kW 2969 cc	03.1983-11.1990	132062	23
AUDI	100 Avant (44, 44Q, C3) / 2.0 E	85 kW 2260 cc	01.1985-12.1987	132021	17
AUDI	100 Avant (44, 44Q, C3) / 2.0 TD	64 kW 1753 cc	03.1983-10.1987	132061	23
AUDI	100 Avant (44, 44Q, C3) / 2.0 TD	64 kW 1986 cc	03.1983-10.1987	132062	23
AUDI	100 Avant (44, 44Q, C3) / 2.0 TD	64 kW 1986 cc	03.1983-10.1987	132063	23
AUDI	100 Avant (44, 44Q, C3) / 2.0 TD	74 kW 1986 cc (NC)	03.1988-11.1990	132061	23
AUDI	100 Avant (44, 44Q, C3) / 2.1	100 kW 1997 cc	08.1982-07.1984	132021	17
AUDI	100 Avant (44, 44Q, C3) / 2.4 D	60 kW 2370 cc	08.1989-11.1990	132061	23
AUDI	100 Avant (44, 44Q, C3) / 2.4 D	60 kW 2370 cc	08.1989-11.1990	132062	23
AUDI	100 Avant (44, 44Q, C3) / 2.4 D	60 kW 2370 cc	08.1989-11.1990	132063	23
AUDI	100 Avant (44, 44Q, C3) / 2.5 TDI	88 kW 1986 cc	01.1990-11.1990	132061	23
AUDI	100 Avant (4A, C4) / 2.4 D	60 kW 2370 cc (AAS)	12.1990-06.1994	132061	23
AUDI	100 Avant (4A, C4) / 2.5 TDI	85 kW 2461 cc (AAT)	12.1990-06.1994	132061	23
AUDI	100 Stufenh. (43, C2) / 2.0 D	51 kW 1986 cc	08.1978-07.1982	132062	23
AUDI	100 Stufenh. (43, C2) / 2.0 D	51 kW 1986 cc	08.1978-07.1982	132063	23
AUDI	100 Stufenh. (4A, C4) / 2.4 D	60 kW 2370 cc	12.1990-06.1994	132061	23
AUDI	100 Stufenh. (4A, C4) / 2.5 TDI	85 kW 2461 cc	12.1990-06.1994	132061	23
AUDI	200 (43) / 2.1 5 T	125 kW 2304 cc	10.1979-08.1982	132021	17
AUDI	200 Stufenh. (43) / 2.1 5 T	125 kW 2144 cc	10.1979-08.1982	132021	17
AUDI	80 (81, 85, B2) / 1.6 D	40 kW 1588 cc	08.1980-08.1986	132062	23
AUDI	80 (81, 85, B2) / 1.6 D	40 kW 1588 cc	08.1980-08.1986	132063	23
AUDI	80 (81, 85, B2) / 1.6 D	40 kW 1781 cc	08.1980-08.1986	132061	23
AUDI	80 (81, 85, B2) / 1.6 TD	51 kW 1588 cc	08.1981-05.1986	132062	23
AUDI	80 (81, 85, B2) / 1.6 TD	51 kW 1588 cc	08.1981-05.1986	132063	23
AUDI	80 (81, 85, B2) / 1.8	65 kW 1396 cc	02.1986-07.1986	132020	16



	Modell Model	Motor Engine	 Baujahr Construction year	HÜCO-NO.	Seite Page
AUDI	80 (81, 85, B2) / 1.8	66 kW 1781 cc	01.1983-08.1986	132021	17
AUDI	80 (81, 85, B2) / 1.8	68 kW 1910 cc	08.1983-08.1986	132021	17
AUDI	80 (81, 85, B2) / 1.8 CC quat. (85Q)	66 kW 1781 cc	08.1984-08.1986	132021	17
AUDI	80 (81, 85, B2) / 1.8 CC quat. (85Q)	66 kW 1968 cc	08.1984-08.1986	132020	16
AUDI	80 (81, 85, B2) / 1.8 CC quat. (85Q)	68 kW 1910 cc	08.1985-08.1986	132020	16
AUDI	80 (81, 85, B2) / 1.8 GTE	81 kW 1781 cc	08.1985-07.1986	132023	17
AUDI	80 (81, 85, B2) / 1.8 GTE	82 kW 1753 cc	10.1984-08.1986	132023	17
AUDI	80 (81, 85, B2) / 1.8 GTE quat.	81 kW 1598 cc	03.1985-08.1986	132020	16
AUDI	80 (81, 85, B2) / 1.8 GTE quat.	81 kW 1781 cc	03.1985-08.1986	132023	17
AUDI	80 (81, 85, B2) / 1.8 GTE quat.	82 kW 1781 cc	08.1984-08.1986	132023	17
AUDI	80 (81, 85, B2) / 1.8 GTE quat.	82 kW 2500 cc	08.1984-08.1986	132020	16
AUDI	80 (89, 89Q, 8A, B3) / 1.6 D	40 kW 1588 cc	09.1986-08.1991	132063	23
AUDI	80 (89, 89Q, 8A, B3) / 1.6 D	40 kW 1598 cc	09.1986-08.1991	132062	23
AUDI	80 (89, 89Q, 8A, B3) / 1.6 TD	59 kW 1588 cc	09.1986-08.1991	132062	23
AUDI	80 (89, 89Q, 8A, B3) / 1.6 TD	59 kW 1588 cc	09.1986-08.1991	132063	23
AUDI	80 (89, 89Q, 8A, B3) / 1.6 TD	59 kW 1588 cc (SB)	09.1986-08.1991	132061	23
AUDI	80 (89, 89Q, 8A, B3) / 1.8	55 kW 2299 cc	10.1986-01.1990	132020	16
AUDI	80 (89, 89Q, 8A, B3) / 1.8	83 kW 1968 cc	09.1986-07.1988	132020	16
AUDI	80 (89, 89Q, 8A, B3) / 1.8 E	82 kW 1968 cc	06.1986-08.1991	132020	16
AUDI	80 (89, 89Q, 8A, B3) / 1.8 quat.	83 kW 1781 cc	09.1986-08.1990	132020	16
AUDI	80 (89, 89Q, 8A, B3) / 1.8 S	65 kW 1781 cc	09.1986-12.1990	132020	16
AUDI	80 (89, 89Q, 8A, B3) / 1.8 S	66 kW 1781 cc	09.1986-10.1991	132020	16
AUDI	80 (89, 89Q, 8A, B3) / 1.8 S quat.	65 kW 1870 cc	09.1986-07.1990	132020	16
AUDI	80 (89, 89Q, 8A, B3) / 1.8 S quat.	66 kW 1781 cc	09.1986-09.1991	132020	16
AUDI	80 (89, 89Q, 8A, B3) / 1.9 D	50 kW 1588 cc	08.1989-08.1991	132061	23
AUDI	80 (89, 89Q, 8A, B3) / 1.9 D	50 kW 1896 cc	08.1989-08.1991	132062	23
AUDI	80 (89, 89Q, 8A, B3) / 1.9 D	50 kW 1896 cc	08.1989-08.1991	132063	23
AUDI	80 (8C, B4) / 1.9 TD	55 kW 1896 cc (AAZ)	09.1991-12.1994	132062	23
AUDI	80 Avant (8C, B4) / 1.9 TD	55 kW 1896 cc (AAZ)	09.1991-12.1994	132062	23
AUDI	80 Stufenh. 1.8 CC quat.	66 kW 1781 cc	08.1984-08.1986	132020	16
AUDI	80 Stufenh. 1.8 CC quat.	66 kW 1781 cc	08.1984-08.1986	132021	17
AUDI	80 Stufenh. 1.8 CC quat.	68 kW 1781 cc	08.1985-08.1986	132020	16
AUDI	80 Stufenh. 1.8 GTE quat.	81 kW 1781 cc	03.1985-08.1986	132020	16
AUDI	80 Stufenh. 1.8 GTE quat.	81 kW 1781 cc	03.1985-08.1986	132023	17
AUDI	80 Stufenh. 1.8 GTE quat.	82 kW 1781 cc	08.1984-08.1986	132020	16
AUDI	80 Stufenh. 1.8 GTE quat.	82 kW 1781 cc	08.1984-08.1986	132023	17
AUDI	80 Stufenh. 1.8 quat.	83 kW 1847 cc	09.1986-08.1990	132020	16
AUDI	80 Stufenh. 1.8 S quat.	65 kW 1781 cc	09.1986-07.1990	132020	16
AUDI	80 Stufenh. 1.8 S quat.	66 kW 1781 cc	09.1986-09.1991	132020	16
AUDI	80 Stufenh. (81, 85, B2) / 1.6 D	40 kW 1588 cc	08.1980-08.1986	132061	23
AUDI	80 Stufenh. (81, 85, B2) / 1.6 D	40 kW 1588 cc	08.1980-08.1986	132062	23
AUDI	80 Stufenh. (81, 85, B2) / 1.6 D	40 kW 1588 cc	08.1980-08.1986	132063	23
AUDI	80 Stufenh. (81, 85, B2) / 1.6 TD	51 kW 1588 cc	08.1981-05.1986	132062	23
AUDI	80 Stufenh. (81, 85, B2) / 1.6 TD	51 kW 1588 cc	08.1981-05.1986	132063	23
AUDI	80 Stufenh. (81, 85, B2) / 1.8	65 kW 1781 cc	02.1986-07.1986	132020	16
AUDI	80 Stufenh. (81, 85, B2) / 1.8	66 kW 1781 cc	01.1983-08.1986	132021	17
AUDI	80 Stufenh. (81, 85, B2) / 1.8	68 kW 1781 cc	08.1983-08.1986	132021	17
AUDI	80 Stufenh. (81, 85, B2) / 1.8 GTE	81 kW 1781 cc	08.1985-07.1986	132023	17
AUDI	80 Stufenh. (81, 85, B2) / 1.8 GTE	82 kW 1781 cc	10.1984-08.1986	132023	17
AUDI	80 Stufenh. (89, 89Q, 8A, B3) / 1.6 D	40 kW 1588 cc	09.1986-08.1991	132062	23
AUDI	80 Stufenh. (89, 89Q, 8A, B3) / 1.6 D	40 kW 1588 cc	09.1986-08.1991	132063	23
AUDI	80 Stufenh. (89, 89Q, 8A, B3) / 1.6 TD	59 kW 1588 cc	09.1986-08.1991	132061	23
AUDI	80 Stufenh. (89, 89Q, 8A, B3) / 1.6 TD	59 kW 1588 cc	09.1986-08.1991	132062	23
AUDI	80 Stufenh. (89, 89Q, 8A, B3) / 1.6 TD	59 kW 1588 cc	09.1986-08.1991	132063	23
AUDI	80 Stufenh. (89, 89Q, 8A, B3) / 1.8	55 kW 1781 cc	10.1986-01.1990	132020	16
AUDI	80 Stufenh. (89, 89Q, 8A, B3) / 1.8	83 kW 1847 cc	09.1986-07.1988	132020	16
AUDI	80 Stufenh. (89, 89Q, 8A, B3) / 1.8 E	82 kW 1781 cc	06.1986-08.1991	132020	16
AUDI	80 Stufenh. (89, 89Q, 8A, B3) / 1.8 S	65 kW 1781 cc	09.1986-12.1990	132020	16
AUDI	80 Stufenh. (89, 89Q, 8A, B3) / 1.8 S	66 kW 1781 cc	09.1986-10.1991	132020	16
AUDI	80 Stufenh. (89, 89Q, 8A, B3) / 1.9 D	50 kW 1896 cc	08.1989-08.1991	132061	23
AUDI	80 Stufenh. (89, 89Q, 8A, B3) / 1.9 D	50 kW 1896 cc	08.1989-08.1991	132062	23
AUDI	80 Stufenh. (89, 89Q, 8A, B3) / 1.9 D	50 kW 1896 cc	08.1989-08.1991	132063	23
AUDI	80 Stufenh. (8C, B4) / 1.9 TD	55 kW 1896 cc	09.1991-12.1994	132062	23
AUDI	90 (81, 85, B2) / 1.6 TD	51 kW 1588 cc	10.1985-01.1987	132063	23
AUDI	90 (81, 85, B2) / 1.6 TD	51 kW 1753 cc	10.1985-01.1987	132062	23
AUDI	90 (89, 89Q, 8A, B3) / 1.6 TD	59 kW 1588 cc	04.1987-09.1991	132062	23
AUDI	90 (89, 89Q, 8A, B3) / 1.6 TD	59 kW 1588 cc	04.1987-09.1991	132063	23



Modell
Model

Motor
Engine



Baujahr
Construction year

HÜCO-NO.

Seite
Page

AUDI	90 (89, 89Q, 8A, B3) / 1.6 TD	59 kW 1588 cc (SB)	04.1987-09.1991	132061	23
AUDI	90 (89, 89Q, 8A, B3) / 2.2 E	100 kW 2498 cc	04.1987-07.1991	132021	17
AUDI	90 (89, 89Q, 8A, B3) / 2.2 E quat.	100 kW 2226 cc	04.1987-09.1991	132021	17
AUDI	90 Stufenh. 2.2 E quat.	100 kW 2226 cc	04.1987-09.1991	132021	17
AUDI	90 Stufenh. (81, 85, B2) / 1.6 TD	51 kW 1588 cc	10.1985-01.1987	132062	23
AUDI	90 Stufenh. (81, 85, B2) / 1.6 TD	51 kW 1588 cc	10.1985-01.1987	132063	23
AUDI	90 Stufenh. (89, 89Q, 8A, B3) / 1.6 TD	59 kW 1588 cc	04.1987-09.1991	132061	23
AUDI	90 Stufenh. (89, 89Q, 8A, B3) / 1.6 TD	59 kW 1588 cc	04.1987-09.1991	132062	23
AUDI	90 Stufenh. (89, 89Q, 8A, B3) / 1.6 TD	59 kW 1588 cc	04.1987-09.1991	132063	23
AUDI	90 Stufenh. (89, 89Q, 8A, B3) / 2.2 E	100 kW 2226 cc	04.1987-07.1991	132021	17
AUDI	A1 (8X1) / 1.6 TDI	66 kW 1598 cc (CAYB)	03.2011-	132106	24
AUDI	A1 (8X1) / 1.6 TDI	77 kW 1598 cc	05.2010-	132129	25
AUDI	A1 (8X1) / 1.6 TDI	77 kW 1598 cc (CAYC)	05.2010-	132106	24
AUDI	A1 Sportback (8XA) / 1.6 TDI	66 kW 1598 cc (CAYB)	11.2011-	132106	24
AUDI	A1 Sportback (8XA) / 1.6 TDI	77 kW 1598 cc	11.2011-	132129	25
AUDI	A1 Sportback (8XA) / 1.6 TDI	77 kW 1598 cc (CAYC)	11.2011-	132106	24
AUDI	A2 (8Z0) / 1.4 TDI	55 kW 1422 cc (AMF)	02.2000-08.2005	132128	25
AUDI	A2 (8Z0) / 1.4 TDI	66 kW 1422 cc (ATL)	11.2003-08.2005	132128	25
AUDI	A3 (8L1) / 1.9 TDI	74 kW 1896 cc (AXR)	10.2000-	132128	25
AUDI	A3 (8L1) / 1.9 TDI	96 kW 1896 cc (ASZ)	08.2000-	132105	24
AUDI	A3 (8L1) / 1.9 TDI quat.	96 kW 1896 cc (ASZ)	08.2000-	132105	24
AUDI	A3 (8P1) / 1.6 TDI	66 kW 1598 cc (CAYB)	05.2009-	132106	24
AUDI	A3 (8P1) / 1.6 TDI	77 kW 1598 cc	05.2009-	132129	25
AUDI	A3 (8P1) / 1.6 TDI	77 kW 1598 cc (CAYC)	05.2009-	132106	24
AUDI	A3 (8P1) / 1.9 TDI	77 kW 1896 cc	05.2003-	132106	24
AUDI	A3 (8P1) / 1.9 TDI	77 kW 1896 cc	05.2003-	132107	24
AUDI	A3 (8P1) / 1.9 TDI	77 kW 1896 cc	05.2003-	132128	25
AUDI	A3 (8P1) / 1.9 TDI	77 kW 1896 cc	05.2003-	132129	25
AUDI	A3 (8P1) / 1.9 TDI	77 kW 1896 cc (BKC)	05.2003-	132104	24
AUDI	A3 (8P1) / 2.0 TDI	100 kW 1968 cc	05.2003-	132106	24
AUDI	A3 (8P1) / 2.0 TDI	100 kW 1968 cc	05.2003-	132128	25
AUDI	A3 (8P1) / 2.0 TDI	100 kW 1968 cc	05.2003-	132129	25
AUDI	A3 (8P1) / 2.0 TDI	100 kW 1968 cc (CBAA)	05.2003-	132104	24
AUDI	A3 (8P1) / 2.0 TDI	103 kW 1968 cc	06.2005-	132128	25
AUDI	A3 (8P1) / 2.0 TDI	103 kW 1968 cc (BMM)	06.2005-	132106	24
AUDI	A3 (8P1) / 2.0 TDI	125 kW 1968 cc	03.2006-	132129	25
AUDI	A3 (8P1) / 2.0 TDI	125 kW 1968 cc (CBBB)	03.2006-	132106	24
AUDI	A3 (8P1) / 2.0 TDI 16V	103 kW 1968 cc	05.2003-	132106	24
AUDI	A3 (8P1) / 2.0 TDI 16V	103 kW 1968 cc	05.2003-	132107	24
AUDI	A3 (8P1) / 2.0 TDI 16V	103 kW 1968 cc	05.2003-	132128	25
AUDI	A3 (8P1) / 2.0 TDI 16V	103 kW 1968 cc	05.2003-	132129	25
AUDI	A3 (8P1) / 2.0 TDI 16V	103 kW 1968 cc (CBAB)	05.2003-	132104	24
AUDI	A3 (8P1) / 2.0 TDI 16V quat.	103 kW 1968 cc	08.2004-	132106	24
AUDI	A3 (8P1) / 2.0 TDI 16V quat.	103 kW 1968 cc	08.2004-	132107	24
AUDI	A3 (8P1) / 2.0 TDI 16V quat.	103 kW 1968 cc	08.2004-	132128	25
AUDI	A3 (8P1) / 2.0 TDI 16V quat.	103 kW 1968 cc	08.2004-	132129	25
AUDI	A3 (8P1) / 2.0 TDI 16V quat.	103 kW 1968 cc (CBAB)	08.2004-	132104	24
AUDI	A3 (8P1) / 2.0 TDI quat.	100 kW 1968 cc	05.2003-	132106	24
AUDI	A3 (8P1) / 2.0 TDI quat.	100 kW 1968 cc	05.2003-	132128	25
AUDI	A3 (8P1) / 2.0 TDI quat.	100 kW 1968 cc	05.2003-	132129	25
AUDI	A3 (8P1) / 2.0 TDI quat.	100 kW 1968 cc (AZV)	05.2003-	132104	24
AUDI	A3 (8P1) / 2.0 TDI quat.	103 kW 1968 cc	01.2006-	132128	25
AUDI	A3 (8P1) / 2.0 TDI quat.	103 kW 1968 cc (BMM)	01.2006-	132106	24
AUDI	A3 (8P1) / 2.0 TDI quat.	125 kW 1968 cc	03.2006-	132129	25
AUDI	A3 (8P1) / 2.0 TDI quat.	125 kW 1968 cc (CBBB)	03.2006-	132106	24
AUDI	A3 Cabriolet / 1.6 TDI	77 kW 1598 cc	05.2009-	132129	25
AUDI	A3 Cabriolet / 1.6 TDI	77 kW 1598 cc (CAYC)	05.2009-	132106	24
AUDI	A3 Cabriolet / 1.9 TDI	77 kW 1896 cc	04.2008-	132128	25
AUDI	A3 Cabriolet / 1.9 TDI	77 kW 1896 cc	04.2008-	132129	25
AUDI	A3 Cabriolet / 1.9 TDI	77 kW 1896 cc (BLS)	04.2008-	132106	24
AUDI	A3 Cabriolet / 2.0 TDI	100 kW 1968 cc	04.2008-	132129	25
AUDI	A3 Cabriolet / 2.0 TDI	100 kW 1968 cc (CBAA)	04.2008-	132106	24
AUDI	A3 Cabriolet / 2.0 TDI	103 kW 1968 cc	04.2008-	132129	25
AUDI	A3 Cabriolet / 2.0 TDI	103 kW 1968 cc (CBAB)	04.2008-	132106	24
AUDI	A3 Sportback (8PA) / 1.6 TDI	66 kW 1598 cc (CAYB)	05.2009-	132106	24
AUDI	A3 Sportback (8PA) / 1.6 TDI	77 kW 1598 cc	05.2009-	132129	25
AUDI	A3 Sportback (8PA) / 1.6 TDI	77 kW 1598 cc (CAYC)	05.2009-	132106	24



Modell
Model

Motor
Engine



Baujahr
Construction year

HÜCO-NO. Seite
Page

	Modell Model	Motor Engine	Baujahr Construction year	HÜCO-NO.	Seite Page
AUDI	A3 Sportback (8PA) / 1.9 TDI	77 kW 1896 cc	09.2004-	132106	24
AUDI	A3 Sportback (8PA) / 1.9 TDI	77 kW 1896 cc	09.2004-	132107	24
AUDI	A3 Sportback (8PA) / 1.9 TDI	77 kW 1896 cc	09.2004-	132128	25
AUDI	A3 Sportback (8PA) / 1.9 TDI	77 kW 1896 cc	09.2004-	132129	25
AUDI	A3 Sportback (8PA) / 1.9 TDI	77 kW 1896 cc (BKC)	09.2004-	132104	24
AUDI	A3 Sportback (8PA) / 2.0 TDI	100 kW 1968 cc	09.2004-	132106	24
AUDI	A3 Sportback (8PA) / 2.0 TDI	100 kW 1968 cc	09.2004-	132128	25
AUDI	A3 Sportback (8PA) / 2.0 TDI	100 kW 1968 cc	09.2004-	132129	25
AUDI	A3 Sportback (8PA) / 2.0 TDI	100 kW 1968 cc (CBAA)	09.2004-	132104	24
AUDI	A3 Sportback (8PA) / 2.0 TDI	103 kW 1968 cc	06.2005-	132128	25
AUDI	A3 Sportback (8PA) / 2.0 TDI	103 kW 1968 cc (BMM)	06.2005-	132106	24
AUDI	A3 Sportback (8PA) / 2.0 TDI	125 kW 1968 cc	03.2006-	132129	25
AUDI	A3 Sportback (8PA) / 2.0 TDI	125 kW 1968 cc (CBBB)	03.2006-	132106	24
AUDI	A3 Sportback (8PA) / 2.0 TDI 16V	103 kW 1968 cc	09.2004-	132106	24
AUDI	A3 Sportback (8PA) / 2.0 TDI 16V	103 kW 1968 cc	09.2004-	132107	24
AUDI	A3 Sportback (8PA) / 2.0 TDI 16V	103 kW 1968 cc	09.2004-	132128	25
AUDI	A3 Sportback (8PA) / 2.0 TDI 16V	103 kW 1968 cc	09.2004-	132129	25
AUDI	A3 Sportback (8PA) / 2.0 TDI 16V	103 kW 1968 cc (CBAB)	09.2004-	132104	24
AUDI	A3 Sportback (8PA) / 2.0 TDI 16V quat.	103 kW 1968 cc	11.2005-	132106	24
AUDI	A3 Sportback (8PA) / 2.0 TDI 16V quat.	103 kW 1968 cc	11.2005-	132107	24
AUDI	A3 Sportback (8PA) / 2.0 TDI 16V quat.	103 kW 1968 cc	11.2005-	132128	25
AUDI	A3 Sportback (8PA) / 2.0 TDI 16V quat.	103 kW 1968 cc	11.2005-	132129	25
AUDI	A3 Sportback (8PA) / 2.0 TDI 16V quat.	103 kW 1968 cc (CBAB)	11.2005-	132104	24
AUDI	A3 Sportback (8PA) / 2.0 TDI quat.	103 kW 1968 cc	01.2006-	132128	25
AUDI	A3 Sportback (8PA) / 2.0 TDI quat.	103 kW 1968 cc (BMM)	01.2006-	132106	24
AUDI	A3 Sportback (8PA) / 2.0 TDI quat.	125 kW 1968 cc	03.2006-	132129	25
AUDI	A3 Sportback (8PA) / 2.0 TDI quat.	125 kW 1968 cc (CBBB)	03.2006-	132106	24
AUDI	A4 (8E2, B6) / 1.9 TDI	85 kW 1896 cc	06.2004-12.2004	132129	25
AUDI	A4 (8E2, B6) / 1.9 TDI	85 kW 1896 cc (BKE)	06.2004-12.2004	132128	25
AUDI	A4 (8EC, B7) / 1.9 TDI	85 kW 1896 cc	11.2004-06.2008	132129	25
AUDI	A4 (8EC, B7) / 1.9 TDI	85 kW 1896 cc (BKE)	11.2004-06.2008	132128	25
AUDI	A4 (8EC, B7) / 2.0 TDI	100 kW 1968 cc	11.2004-06.2008	132129	25
AUDI	A4 (8EC, B7) / 2.0 TDI	100 kW 1968 cc (BNA)	11.2004-06.2008	132128	25
AUDI	A4 (8EC, B7) / 2.0 TDI	103 kW 1968 cc (BPW)	11.2004-06.2008	132129	25
AUDI	A4 (8EC, B7) / 2.0 TDI	125 kW 1968 cc (BRD)	06.2006-06.2008	132129	25
AUDI	A4 (8EC, B7) / 2.0 TDI	89 kW 1968 cc (BVG)	09.2005-09.2006	132129	25
AUDI	A4 (8EC, B7) / 2.0 TDI	93 kW 1968 cc (BVF)	11.2005-11.2006	132129	25
AUDI	A4 (8EC, B7) / 2.0 TDI 16V	103 kW 1968 cc	11.2004-06.2008	132129	25
AUDI	A4 (8EC, B7) / 2.0 TDI 16V	103 kW 1968 cc (BRE)	11.2004-06.2008	132128	25
AUDI	A4 (8EC, B7) / 2.0 TDI quat.	103 kW 1968 cc (BPW)	01.2006-06.2008	132129	25
AUDI	A4 (8EC, B7) / 2.0 TDI quat.	125 kW 1968 cc (BRD)	06.2006-06.2008	132129	25
AUDI	A4 (8K2, B8) / 2.0 TDI	100 kW 1968 cc (CAGB)	11.2007-	132129	25
AUDI	A4 (8K2, B8) / 2.0 TDI	105 kW 1968 cc (CAGA)	11.2007-	132129	25
AUDI	A4 (8K2, B8) / 2.0 TDI	120 kW 1968 cc (CAHB)	08.2008-	132129	25
AUDI	A4 (8K2, B8) / 2.0 TDI	125 kW 1968 cc (CAHA)	01.2008-	132129	25
AUDI	A4 (8K2, B8) / 2.0 TDi	88 kW 1968 cc (CAGC)	06.2008-	132129	25
AUDI	A4 (8K2, B8) / 2.0 TDI quat.	105 kW 1968 cc (CAGA)	11.2008-	132129	25
AUDI	A4 (8K2, B8) / 2.0 TDi quat.	125 kW 1968 cc (CAHA)	01.2008-	132129	25
AUDI	A4 Allroad (8KH, B8) / 2.0 TDI quat.	100 kW 1968 cc (CAGB)	09.2009-	132129	25
AUDI	A4 Allroad (8KH, B8) / 2.0 TDI quat.	105 kW 1968 cc (CAGA)	09.2009-	132129	25
AUDI	A4 Allroad (8KH, B8) / 2.0 TDI quat.	120 kW 1968 cc (CAHB)	04.2009-	132129	25
AUDI	A4 Allroad (8KH, B8) / 2.0 TDI quat.	125 kW 1968 cc (CAHA)	04.2009-	132129	25
AUDI	A4 Allroad Kombi 2.0 TDI quat.	100 kW 1968 cc	09.2009-	132129	25
AUDI	A4 Allroad Kombi 2.0 TDI quat.	105 kW 1968 cc	09.2009-	132129	25
AUDI	A4 Allroad Kombi 2.0 TDI quat.	120 kW 1968 cc	04.2009-	132129	25
AUDI	A4 Allroad Kombi 2.0 TDI quat.	125 kW 1968 cc	04.2009-	132129	25
AUDI	A4 Avant (8E5, B6) / 1.9 TDI	85 kW 1896 cc	06.2004-12.2004	132129	25
AUDI	A4 Avant (8E5, B6) / 1.9 TDI	85 kW 1896 cc (BKE)	06.2004-12.2004	132128	25
AUDI	A4 Avant (8ED, B7) / 1.9 TDI	85 kW 1896 cc	11.2004-06.2008	132129	25
AUDI	A4 Avant (8ED, B7) / 1.9 TDI	85 kW 1896 cc (BKE)	11.2004-06.2008	132128	25
AUDI	A4 Avant (8ED, B7) / 2.0 TDI	100 kW 1968 cc	11.2004-06.2008	132129	25
AUDI	A4 Avant (8ED, B7) / 2.0 TDI	100 kW 1968 cc (BNA)	11.2004-06.2008	132128	25
AUDI	A4 Avant (8ED, B7) / 2.0 TDI	125 kW 1968 cc (BRD)	06.2006-06.2008	132129	25
AUDI	A4 Avant (8ED, B7) / 2.0 TDI	89 kW 1968 cc (BVG)	09.2005-09.2006	132129	25
AUDI	A4 Avant (8ED, B7) / 2.0 TDI	93 kW 1968 cc (BVF)	11.2005-11.2006	132129	25
AUDI	A4 Avant (8ED, B7) / 2.0 TDI 16V	103 kW 1968 cc	11.2004-06.2008	132129	25
AUDI	A4 Avant (8ED, B7) / 2.0 TDI 16V	103 kW 1968 cc (BRE)	11.2004-06.2008	132128	25



Modell
Model

Motor
Engine



Baujahr
Construction year

HÜCO-NO.

Seite
Page

AUDI	A4 Avant (8ED, B7) / 2.0 TDI quat.	103 kW 1968 cc (BPW)	01.2006-06.2008	132129	25
AUDI	A4 Avant (8ED, B7) / 2.0 TDI quat.	125 kW 1968 cc (BRD)	06.2006-06.2008	132129	25
AUDI	A4 Avant (8K5, B8) / 2.0 TDI	100 kW 1968 cc (CAGB)	04.2008-	132129	25
AUDI	A4 Avant (8K5, B8) / 2.0 TDI	105 kW 1968 cc (CAGA)	04.2008-	132129	25
AUDI	A4 Avant (8K5, B8) / 2.0 TDI	120 kW 1968 cc (CAHB)	08.2008-	132129	25
AUDI	A4 Avant (8K5, B8) / 2.0 TDI	125 kW 1968 cc (CAHA)	04.2008-	132129	25
AUDI	A4 Avant (8K5, B8) / 2.0 TDI	88 kW 1968 cc (CAGC)	06.2008-	132129	25
AUDI	A4 Avant (8K5, B8) / 2.0 TDI quat.	105 kW 1968 cc (CAGA)	04.2008-	132129	25
AUDI	A4 Avant (8K5, B8) / 2.0 TDI quat.	125 kW 1968 cc (CAHA)	08.2008-	132129	25
AUDI	A4 Cabriolet / 2.0 TDI	103 kW 1968 cc (BPW)	01.2006-03.2009	132129	25
AUDI	A4 Stufenh. (8EC, B7) / 1.9 TDI	85 kW 1896 cc	11.2004-06.2008	132128	25
AUDI	A4 Stufenh. (8EC, B7) / 1.9 TDI	85 kW 1896 cc	11.2004-06.2008	132129	25
AUDI	A4 Stufenh. (8EC, B7) / 2.0 TDI	100 kW 1968 cc	11.2004-06.2008	132128	25
AUDI	A4 Stufenh. (8EC, B7) / 2.0 TDI	100 kW 1968 cc	11.2004-06.2008	132129	25
AUDI	A4 Stufenh. (8EC, B7) / 2.0 TDI	103 kW 1968 cc	11.2004-06.2008	132129	25
AUDI	A4 Stufenh. (8EC, B7) / 2.0 TDI	125 kW 1968 cc	06.2006-06.2008	132129	25
AUDI	A4 Stufenh. (8EC, B7) / 2.0 TDI	89 kW 1968 cc	09.2005-09.2006	132129	25
AUDI	A4 Stufenh. (8EC, B7) / 2.0 TDI	93 kW 1968 cc	11.2005-11.2006	132129	25
AUDI	A4 Stufenh. (8EC, B7) / 2.0 TDI 16V	103 kW 1968 cc	11.2004-06.2008	132128	25
AUDI	A4 Stufenh. (8EC, B7) / 2.0 TDI 16V	103 kW 1968 cc	11.2004-06.2008	132129	25
AUDI	A4 Stufenh. (8EC, B7) / 2.0 TDI quat.	103 kW 1968 cc	01.2006-06.2008	132129	25
AUDI	A4 Stufenh. (8EC, B7) / 2.0 TDI quat.	125 kW 1968 cc	06.2006-06.2008	132129	25
AUDI	A4 Stufenh. (8K2, B8) / 2.0 TDI	100 kW 1968 cc	11.2007-	132129	25
AUDI	A4 Stufenh. (8K2, B8) / 2.0 TDI	105 kW 1968 cc	11.2007-	132129	25
AUDI	A4 Stufenh. (8K2, B8) / 2.0 TDI	120 kW 1968 cc	08.2008-	132129	25
AUDI	A4 Stufenh. (8K2, B8) / 2.0 TDI	125 kW 1968 cc	01.2008-	132129	25
AUDI	A4 Stufenh. (8K2, B8) / 2.0 TDi	88 kW 1968 cc	06.2008-	132129	25
AUDI	A4 Stufenh. (8K2, B8) / 2.0 TDI quat.	105 kW 1968 cc	11.2008-	132129	25
AUDI	A4 Stufenh. (8K2, B8) / 2.0 TDi quat.	125 kW 1968 cc	01.2008-	132129	25
AUDI	A5 (8T3) / 2.0 TDI	120 kW 1968 cc (CAHB)	08.2008-	132129	25
AUDI	A5 (8T3) / 2.0 TDI	125 kW 1968 cc (CAHA)	08.2008-	132129	25
AUDI	A5 (8T3) / 2.0 TDI quat.	125 kW 1968 cc (CAHA)	08.2008-	132129	25
AUDI	A5 Cabriolet (8F7) / 2.0 TDI	120 kW 1968 cc (CAHB)	05.2009-	132129	25
AUDI	A5 Cabriolet (8F7) / 2.0 TDI	125 kW 1968 cc (CAHA)	05.2009-	132129	25
AUDI	A5 Sportback (8TA) / 2.0 TDI	100 kW 1968 cc (CAGB)	09.2009-	132129	25
AUDI	A5 Sportback (8TA) / 2.0 TDI	105 kW 1968 cc (CAGA)	09.2009-	132129	25
AUDI	A5 Sportback (8TA) / 2.0 TDI	120 kW 1968 cc (CAHB)	09.2009-	132129	25
AUDI	A5 Sportback (8TA) / 2.0 TDI	125 kW 1968 cc (CAHA)	09.2009-	132129	25
AUDI	A5 Sportback (8TA) / 2.0 TDI quat.	125 kW 1968 cc (CAHA)	09.2009-	132129	25
AUDI	A6 (4A, C4) / 2.5 TDI	84 kW 2461 cc (AAT)	01.1995-10.1997	132061	23
AUDI	A6 (4A, C4) / 2.5 TDI	85 kW 2461 cc (AAT)	06.1994-10.1997	132061	23
AUDI	A6 (4F2, C6) / 2.0 TDI	100 kW 1968 cc	07.2004-03.2011	132129	25
AUDI	A6 (4F2, C6) / 2.0 TDI	100 kW 1968 cc (BNA)	07.2004-03.2011	132128	25
AUDI	A6 (4F2, C6) / 2.0 TDI	103 kW 1968 cc	07.2004-10.2008	132129	25
AUDI	A6 (4F2, C6) / 2.0 TDI	103 kW 1968 cc (BRE)	07.2004-10.2008	132128	25
AUDI	A6 (4F2, C6) / 2.0 TDI	120 kW 1968 cc (CAHB)	04.2009-03.2011	132129	25
AUDI	A6 (4F2, C6) / 2.0 TDI	125 kW 1968 cc (CAHA)	11.2008-03.2011	132129	25
AUDI	A6 (4F2, C6) / 2.0 TDI	89 kW 1968 cc (BVG)	09.2005-06.2006	132129	25
AUDI	A6 (4F2, C6) / 3.0 TFSI quat.	213 kW 2995 cc (CAJA)	10.2008-03.2011	132106	24
AUDI	A6 Allroad (4FH, C6) / 3.0 TFSI quat.	213 kW 2995 cc (CAJA)	10.2008-	132106	24
AUDI	A6 Allroad Kombi 3.0 TFSI quat.	213 kW 2995 cc	10.2008-	132106	24
AUDI	A6 Avant (4A, C4) / 2.5 TDI	84 kW 2461 cc (AAT)	01.1995-12.1997	132061	23
AUDI	A6 Avant (4A, C4) / 2.5 TDI	85 kW 2461 cc (AAT)	06.1994-12.1997	132061	23
AUDI	A6 Avant (4F5, C6) / 2.0 TDI	100 kW 1968 cc	06.2005-08.2011	132129	25
AUDI	A6 Avant (4F5, C6) / 2.0 TDI	100 kW 1968 cc (BNA)	06.2005-08.2011	132128	25
AUDI	A6 Avant (4F5, C6) / 2.0 TDI	103 kW 1968 cc	06.2005-10.2008	132129	25
AUDI	A6 Avant (4F5, C6) / 2.0 TDI	103 kW 1968 cc (BRE)	06.2005-10.2008	132128	25
AUDI	A6 Avant (4F5, C6) / 2.0 TDI	120 kW 1968 cc (CAHB)	04.2009-08.2011	132129	25
AUDI	A6 Avant (4F5, C6) / 2.0 TDI	125 kW 1968 cc (CAHA)	10.2008-08.2011	132129	25
AUDI	A6 Avant (4F5, C6) / 2.0 TDI	89 kW 1968 cc (BVG)	09.2005-06.2006	132129	25
AUDI	A6 Avant (4F5, C6) / 3.0 TFSI quat.	213 kW 2995 cc (CAJA)	10.2008-08.2011	132106	24
AUDI	A6 Stufenh. (4A, C4) / 2.5 TDI	84 kW 2461 cc	01.1995-10.1997	132061	23
AUDI	A6 Stufenh. (4A, C4) / 2.5 TDI	85 kW 2461 cc	06.1994-10.1997	132061	23
AUDI	A6 Stufenh. (4F2, C6) / 2.0 TDI	100 kW 1968 cc	07.2004-03.2011	132128	25
AUDI	A6 Stufenh. (4F2, C6) / 2.0 TDI	100 kW 1968 cc	07.2004-03.2011	132129	25
AUDI	A6 Stufenh. (4F2, C6) / 2.0 TDI	103 kW 1968 cc	07.2004-10.2008	132128	25
AUDI	A6 Stufenh. (4F2, C6) / 2.0 TDI	103 kW 1968 cc	07.2004-10.2008	132129	25



Modell
Model

Motor
Engine



Baujahr
Construction year

HÜCO-NO. Seite
Page

	Modell Model	Motor Engine	Baujahr Construction year	HÜCO-NO.	Seite Page
AUDI	A6 Stufenh. (4F2, C6) / 2.0 TDI	120 kW 1968 cc	04.2009-03.2011	132129	25
AUDI	A6 Stufenh. (4F2, C6) / 2.0 TDI	125 kW 1968 cc	11.2008-03.2011	132129	25
AUDI	A6 Stufenh. (4F2, C6) / 2.0 TDI	89 kW 1968 cc	09.2005-06.2006	132129	25
AUDI	A6 Stufenh. (4F2, C6) / 3.0 TFSI quat.	213 kW 2995 cc	10.2008-03.2011	132106	24
AUDI	A8 (4E_) / 4.2 TDI quat.	240 kW 4134 cc (BVN)	07.2005-07.2010	132129	25
AUDI	A8 Stufenh. (4E_) / 4.2 TDI quat.	240 kW 4134 cc	07.2005-07.2010	132129	25
AUDI	COUPE (81, 85) / 1.8 GT	65 kW 1699 cc	04.1986-10.1988	132020	16
AUDI	COUPE (81, 85) / 1.8 GT	66 kW 1699 cc	09.1982-10.1988	132020	16
AUDI	COUPE (81, 85) / 1.8 GT	68 kW 1910 cc	01.1985-07.1988	132020	16
AUDI	COUPE (81, 85) / 1.8 GT	79 kW 1781 cc	08.1986-10.1987	132020	16
AUDI	COUPE (81, 85) / 1.8 GT	82 kW 2226 cc	08.1986-10.1988	132020	16
AUDI	COUPE (81, 85) / 2.0	83 kW 1598 cc	03.1986-04.1988	132021	17
AUDI	COUPE (81, 85) / 2.0	85 kW 1389 cc	09.1983-07.1986	132021	17
AUDI	COUPE (89, 8B) / 1.8	82 kW 1781 cc	08.1989-07.1991	132020	16
AUDI	COUPE (89, 8B) / 2.0 20 V quat.	118 kW 1769 cc	08.1989-07.1991	132021	17
AUDI	COUPE (89, 8B) / 2.2 quat.	100 kW 1598 cc	11.1988-07.1991	132021	17
AUDI	Q3 / 2.0 TDI	103 kW 1968 cc	09.2011-	132129	25
AUDI	Q3 / 2.0 TDI	103 kW 1968 cc (CFFB)	09.2011-	132106	24
AUDI	Q3 / 2.0 TDI quat.	120 kW 1968 cc (CFGD)	06.2011-	132106	24
AUDI	Q3 / 2.0 TDI quat.	130 kW 1968 cc (CFGC)	06.2011-	132106	24
AUDI	Q5 (8R) / 2.0 TDI	100 kW 1968 cc (CAGB)	08.2009-	132129	25
AUDI	Q5 (8R) / 2.0 TDI	105 kW 1968 cc (CAGA)	08.2009-	132129	25
AUDI	Q5 (8R) / 2.0 TDI	120 kW 1968 cc (CAHB)	11.2008-	132129	25
AUDI	Q5 (8R) / 2.0 TDI	125 kW 1968 cc (CAHA)	11.2008-	132129	25
AUDI	Q5 (8R) / 2.0 TDI FWD	100 kW 1968 cc (CICB)	11.2010-	132129	25
AUDI	Q5 (8R) / 2.0 TDI FWD	105 kW 1968 cc (CICA)	11.2010-	132129	25
AUDI	Q7 (4L) / 4.2 TDI	250 kW 4134 cc (CCFA)	05.2009-	132129	25
AUDI	TT (8J3) / 2.0 TDI quat.	125 kW 1968 cc (CBBB)	06.2008-	132129	25
AUDI	TT Roadster (8J9) / 2.0 TDI quat.	125 kW 1968 cc (CBBB)	06.2008-	132129	25
BAW	LUBA / 2.4	105 kW 2438 cc (G9U650)	01.2005-	132122	32
BMW	3 (E30) / 318 i	75 kW 1905 cc	12.1984-08.1988	132019	16
BMW	3 (E30) / 320 i	92 kW 1461 cc	09.1982-12.1985	132010	15
BMW	3 (E30) / 320 i	92 kW 1990 cc	09.1982-12.1985	132019	16
BMW	3 (E30) / 320 i	95 kW 1272 cc	12.1985-06.1991	132010	15
BMW	3 (E30) / 320 i	95 kW 1991 cc	12.1985-06.1991	132019	16
BMW	3 (E30) / 323 i	102 kW 1461 cc	09.1982-08.1983	132019	16
BMW	3 (E30) / 323 i	110 kW 2299 cc	09.1983-08.1986	132019	16
BMW	3 Cabriolet (E30) / 320 i	95 kW 1975 cc	04.1986-10.1993	132010	15
BMW	3 Cabriolet (E30) / 320 i	95 kW 1990 cc	04.1986-10.1993	132019	16
BMW	3 Cabriolet (E30) / 325 i	125 kW 1990 cc	09.1987-10.1993	132019	16
BMW	3 Cabriolet (E30) / 325 i	126 kW 1905 cc	12.1985-12.1987	132019	16
BMW	3 Stufenh. (E30) / 318 i	75 kW 1766 cc	12.1984-08.1988	132019	16
BMW	3 Stufenh. (E30) / 320 i	92 kW 1990 cc	09.1982-12.1985	132010	15
BMW	3 Stufenh. (E30) / 320 i	92 kW 1990 cc	09.1982-12.1985	132019	16
BMW	3 Stufenh. (E30) / 320 i	95 kW 1991 cc	12.1985-06.1991	132010	15
BMW	3 Stufenh. (E30) / 320 i	95 kW 1991 cc	12.1985-06.1991	132019	16
BMW	3 Stufenh. (E30) / 323 i	102 kW 2316 cc	09.1982-08.1983	132019	16
BMW	3 Stufenh. (E30) / 323 i	110 kW 2316 cc	09.1983-08.1986	132019	16
BMW	3 Touring (E30) / 320 i	95 kW 2998 cc	01.1988-12.1991	132010	15
BMW	5 (E28) / 520 i	110 kW 1461 cc	12.1986-06.1990	132019	16
BMW	5 (E28) / 520 i	92 kW 2500 cc	06.1981-12.1987	132019	16
BMW	5 (E28) / 520 i	95 kW 1975 cc	08.1985-12.1987	132019	16
BMW	5 (E28) / 525 i	110 kW 1968 cc	06.1981-12.1987	132019	16
BMW	5 (E28) / 528 i	135 kW 1905 cc	06.1981-12.1987	132019	16
BMW	5 Stufenh. (E28) / 520 i	110 kW 1990 cc	12.1986-06.1990	132019	16
BMW	5 Stufenh. (E28) / 520 i	92 kW 1990 cc	06.1981-12.1987	132019	16
BMW	5 Stufenh. (E28) / 520 i	95 kW 1990 cc	08.1985-12.1987	132019	16
BMW	5 Stufenh. (E28) / 525 i	110 kW 2495 cc	06.1981-12.1987	132019	16
BMW	5 Stufenh. (E28) / 528 i	135 kW 2788 cc	06.1981-12.1987	132019	16
BMW	6 (E24) / 630 CS	135 kW 2383 cc	04.1976-08.1979	132019	16
BMW	6 (E24) / 630 CS	136 kW 1905 cc	04.1976-08.1979	132019	16
BMW	6 (E24) / 633 CSi	145 kW 2497 cc	09.1978-08.1984	132019	16
BMW	6 (E24) / 635 CSi	136 kW 2986 cc	01.1985-05.1989	132019	16
BMW	6 (E24) / 635 CSi	155 kW 2500 cc	08.1987-05.1989	132019	16
BMW	6 (E24) / M 635 CSi	191 kW 2299 cc	10.1986-10.1988	132019	16
BMW	6 (E24) / M 635 CSi	211 kW 2428 cc	03.1984-05.1989	132019	16
BMW	7 (E23) / 728	125 kW 2383 cc	05.1977-08.1979	132019	16



Modell
Model

Motor
Engine



Baujahr
Construction year

HÜCO-NO.

Seite
Page

BMW	7 (E23) / 728 i	135 kW 1997 cc	07.1978-08.1986	132019	16
BMW	7 (E23) / 730	135 kW 2383 cc	05.1977-08.1979	132019	16
BMW	7 (E23) / 733 i	145 kW 1870 cc	05.1977-09.1979	132019	16
BMW	7 (E23) / 735 i	136 kW 1896 cc	01.1985-08.1986	132019	16
BMW	7 (E23) / 735 i	141 kW 1998 cc	04.1985-08.1986	132019	16
BMW	7 (E23) / 735 i	160 kW 1968 cc	09.1979-08.1986	132019	16
BMW	7 (E23) / 745 i	185 kW 1870 cc	05.1983-08.1986	132019	16
BMW	7 Stufenh. (E23) / 728	125 kW 2788 cc	05.1977-08.1979	132019	16
BMW	7 Stufenh. (E23) / 728 i	135 kW 2788 cc	07.1978-08.1986	132019	16
BMW	7 Stufenh. (E23) / 730	135 kW 2986 cc	05.1977-08.1979	132019	16
BMW	7 Stufenh. (E23) / 733 i	145 kW 3210 cc	05.1977-09.1979	132019	16
BMW	7 Stufenh. (E23) / 735 i	136 kW 3430 cc	01.1985-08.1986	132019	16
BMW	7 Stufenh. (E23) / 735 i	141 kW 3430 cc	04.1985-08.1986	132019	16
BMW	7 Stufenh. (E23) / 735 i	160 kW 3453 cc	09.1979-08.1986	132019	16
BMW	7 Stufenh. (E23) / 745 i	185 kW 3430 cc	05.1983-08.1986	132019	16
CADILLAC	ESCALADE / 6.0 HYBRID AWD	248 kW 1870 cc	11.2010-	132045	23
CHRYSLER	VOYAGER II (ES) / 3.0 i	108 kW 2972 cc (300)	01.1991-09.1995	132019	16
CITROEN	AX (ZA-) / 1.4 D 4x4	39 kW 1360 cc (K9A(TUD3))	06.1991-07.1992	132080	29
CITROEN	AX (ZA-) / 14 D	37 kW 1360 cc (K9Y(TUD3Y))	08.1991-12.1997	132080	29
CITROEN	AX (ZA-) / 14 D	38 kW 1360 cc	09.1988-06.1992	132052	27
CITROEN	AX (ZA-) / 14 D	38 kW 1360 cc	09.1988-06.1992	132080	29
CITROEN	AX (ZA-) / 14 D	38 kW 1360 cc (K9A(TUD3))	09.1988-06.1992	132051	26
CITROEN	AX (ZA-) / 15 D	40 kW 2446 cc	08.1994-12.1997	132085	30
CITROEN	AX (ZA-) / 15 D	43 kW 1990 cc	08.1994-12.1997	132085	30
CITROEN	BERLINGO / 1.8 D (MBA9A, MCA9A)	43 kW 1769 cc	07.1996-	132080	29
CITROEN	BERLINGO / 2.0 HDI 90 4WD	66 kW 1997 cc	11.2000-	132088	25
CITROEN	BERLINGO 1.8 D (MBA9A, MCA9A)	43 kW 1769 cc	07.1996-	132083	29
CITROEN	BERLINGO (MF) / 1.6 HDI 75 (MF9HW)	55 kW 1997 cc	07.2005-	132122	32
CITROEN	BERLINGO (MF) / 1.6 HDI 90 (MF9HX)	66 kW 1560 cc	07.2005-	132122	32
CITROEN	BERLINGO (MF) / 1.8 D (MFA9A)	43 kW 1769 cc	07.1998-	132083	29
CITROEN	BERLINGO (MF) / 1.8 D (MFA9A)	43 kW 1769 cc (XUD7)	07.1998-	132080	29
CITROEN	BERLINGO (MF) / 1.9 D (MFDJY)	50 kW 1905 cc	07.1996-	132085	30
CITROEN	BERLINGO (MF) / 1.9 D (MFDJY)	50 kW 1905 cc (DJY(XUD9A))	07.1996-	132080	29
CITROEN	BERLINGO (MF) / 1.9 D (MFWJZ)	51 kW 1868 cc (WJZ(DW8B))	07.1998-	132088	25
CITROEN	BERLINGO (MF) / 1.9 D 4WD (MFWJZ)	51 kW 1868 cc (WJZ(DW8))	07.1998-	132088	25
CITROEN	BERLINGO (MF) / 2.0 HDi (MFRHY)	66 kW 1997 cc (DW10TD)	11.2002-10.2005	132088	25
CITROEN	BERLINGO (MF) / 2.0 HDi 4x4 (MFRHY)	66 kW 1997 cc (DW10TD)	11.2002-10.2005	132088	25
CITROEN	BERLINGO (MF) / 2.0 HDI 90 (MFRHY)	66 kW 1997 cc (RHY(DW10TD))	12.1999-	132088	25
CITROEN	BERLINGO I / 1.6 HDI 75 (MB9HW)	55 kW 1968 cc	07.2005-	132122	32
CITROEN	BERLINGO I (MF) / 1.6 HDI 75 (MF9HW)	55 kW 1560 cc	07.2005-	132122	32
CITROEN	BERLINGO I (MF) / 1.6 HDI 90 (MF9HX)	66 kW 1560 cc	07.2005-	132122	32
CITROEN	BERLINGO I (MF) / 1.8 D (MFA9A)	43 kW 1769 cc	07.1998-	132080	29
CITROEN	BERLINGO I (MF) / 1.8 D (MFA9A)	43 kW 1769 cc	07.1998-	132083	29
CITROEN	BERLINGO I (MF) / 1.9 D (MFDJY)	50 kW 1905 cc	07.1996-	132080	29
CITROEN	BERLINGO I (MF) / 1.9 D (MFDJY)	50 kW 1905 cc	07.1996-	132085	30
CITROEN	BERLINGO I (MF) / 1.9 D (MFWJZ)	51 kW 1868 cc	07.1998-	132088	25
CITROEN	BERLINGO I (MF) / 1.9 D 4WD (MFWJZ)	51 kW 1868 cc	07.1998-	132088	25
CITROEN	BERLINGO I (MF) / 2.0 HDi (MFRHY)	66 kW 1997 cc	11.2002-10.2005	132088	25
CITROEN	BERLINGO I (MF) / 2.0 HDi 4x4 (MFRHY)	66 kW 1997 cc	11.2002-10.2005	132088	25
CITROEN	BERLINGO I (MF) / 2.0 HDI 90 (MFRHY)	66 kW 1997 cc	12.1999-	132088	25
CITROEN	BERLINGO I Kasten 1.6 HDI 90	66 kW 1968 cc	07.2005-	132122	32
CITROEN	BERLINGO I Kasten 1.8 D	43 kW 1769 cc	07.1996-	132083	29
CITROEN	BERLINGO I Kasten 1.8 D	43 kW 1769 cc (XUD7)	07.1996-	132080	29
CITROEN	BERLINGO I Kasten 1.9 D 70	51 kW 1868 cc (WJZ(DW8))	04.1999-	132088	25
CITROEN	BERLINGO I Kasten 1.9 D 70 4WD	51 kW 1868 cc (WJZ(DW8))	07.1998-	132088	25
CITROEN	BERLINGO I Kasten 2.0 HDI 90	66 kW 1997 cc (RHY(DW10TD))	12.1999-	132088	25
CITROEN	BERLINGO I Kasten 2.0 HDI 90 4WD	66 kW 1997 cc (RHY(DW10TD))	11.2000-	132088	25
CITROEN	BERLINGO I Kasten (M_) / 1.9 D (MBDJY)	51 kW 1905 cc	07.1996-	132085	30
CITROEN	BERLINGO I Kasten (M_) / 1.9 D (MBDJY)	51 kW 1905 cc (DJY(XUD9A))	07.1996-	132080	29
CITROEN	BERLINGO Kasten 1.6 HDI 90	66 kW 1560 cc	07.2005-	132122	32
CITROEN	BERLINGO Kasten 1.9 D 70	51 kW 1868 cc	04.1999-	132088	25
CITROEN	BERLINGO Kasten 1.9 D 70 4WD	51 kW 1868 cc	07.1998-	132088	25
CITROEN	BERLINGO Kasten 2.0 HDI 90	66 kW 1997 cc	12.1999-	132088	25
CITROEN	BERLINGO Kasten (M_) / 1.6 HDI 75	55 kW 1560 cc	07.2005-	132122	32
CITROEN	BERLINGO Kasten (M_) / 1.9 D (MBDJY)	51 kW 1905 cc	07.1996-	132080	29
CITROEN	BERLINGO Kasten (M_) / 1.9 D (MBDJY)	51 kW 1905 cc	07.1996-	132085	30
CITROEN	BX (XB-) / 1.8 D	44 kW 1769 cc	10.1985-09.1993	132052	27



Modell
Model

Motor
Engine



Baujahr
Construction year

HÜCO-NO. Seite
Page

	Modell Model	Motor Engine	Baujahr Construction year	HÜCO-NO.	Seite Page
CITROEN	BX (XB-) / 1.8 D	44 kW 1796 cc	10.1985-09.1993	132051	26
CITROEN	BX (XB-) / 19 D	47 kW 1769 cc	09.1983-12.1987	132051	26
CITROEN	BX (XB-) / 19 D	47 kW 1905 cc	09.1983-12.1987	132052	27
CITROEN	BX (XB-) / 19 D	51 kW 1905 cc	03.1987-02.1993	132052	27
CITROEN	BX (XB-) / 19 D	51 kW 1905 cc	03.1987-02.1993	132080	29
CITROEN	BX (XB-) / 19 D	51 kW 1905 cc (D9B(XUD9A/U))	03.1987-02.1993	132051	26
CITROEN	BX (XB-) / TRD Turbo	66 kW 1769 cc	03.1988-02.1993	132052	27
CITROEN	BX Break (XB-) / 18 D	44 kW 1769 cc	10.1985-09.1993	132052	27
CITROEN	BX Break (XB-) / 18 D	44 kW 1769 cc	10.1985-09.1993	132080	29
CITROEN	BX Break (XB-) / 18 D	44 kW 1769 cc (161A(XUD7))	10.1985-09.1993	132051	26
CITROEN	BX Break (XB-) / 19 D	47 kW 1769 cc	09.1983-12.1987	132051	26
CITROEN	BX Break (XB-) / 19 D	47 kW 1905 cc	09.1983-12.1987	132052	27
CITROEN	BX Break (XB-) / 19 D	51 kW 1905 cc	03.1987-12.1994	132052	27
CITROEN	BX Break (XB-) / 19 D	51 kW 1905 cc	03.1987-12.1994	132080	29
CITROEN	BX Break (XB-) / 19 D	51 kW 1905 cc (D9B(XUD9A/U))	03.1987-12.1994	132051	26
CITROEN	BX Break (XB-) / TRD Turbo	66 kW 1766 cc	03.1988-12.1994	132051	26
CITROEN	BX Break (XB-) / TRD Turbo	66 kW 1769 cc	03.1988-12.1994	132052	27
CITROEN	C15 (VD-) / 1.8 D	44 kW 1769 cc	07.1986-12.2000	132052	27
CITROEN	C15 (VD-) / 1.8 D	44 kW 1769 cc	07.1986-12.2000	132080	29
CITROEN	C15 (VD-) / 1.8 D	44 kW 1769 cc	07.1986-12.2000	132083	29
CITROEN	C15 (VD-) / 1.8 D	44 kW 1769 cc (XUD7)	07.1986-12.2000	132051	26
CITROEN	C25 Bus (280_, 290_) / 1.9 D	51 kW 1905 cc	07.1987-02.1994	132052	27
CITROEN	C25 Bus (280_, 290_) / 1.9 D	51 kW 1905 cc	07.1987-02.1994	132080	29
CITROEN	C25 Bus (280_, 290_) / 1.9 D	51 kW 1905 cc (D9B(XUD9A/U))	07.1987-02.1994	132051	26
CITROEN	C25 Bus (280_, 290_) / 2.5 D	54 kW 1905 cc	10.1985-02.1994	132050	26
CITROEN	C25 Bus (280_, 290_) / 2.5 D 4x4	54 kW 1998 cc	01.1987-02.1994	132050	26
CITROEN	C25 Bus (280_, 290_) / 2.5 D Turbo	70 kW 1990 cc	08.1987-02.1994	132050	26
CITROEN	C25 Bus (280_, 290_) / 2.5 D Turbo 4x4	70 kW 2500 cc	08.1987-02.1994	132050	26
CITROEN	C25 Kasten (280_, 290_) / 1.9 D 1400	51 kW 1905 cc (DJY(XUD9A))	01.1988-01.1994	132080	29
CITROEN	C25 Kasten (280_, 290_) / 1.9 D 4x4	51 kW 1905 cc (DJY(XUD9A))	01.1988-01.1994	132080	29
CITROEN	C25 Pritsche (280_, 290_) / 1.9	51 kW 1905 cc (DJY(XUD9A))	01.1988-01.1994	132080	29
CITROEN	C4 (LC_) / 2.0 HDi	100 kW 1997 cc (DW10BTED4)	11.2004-	132088	25
CITROEN	C4 Coupe (LA_) / 2.0 HDi	100 kW 1997 cc (DW10BTED4)	11.2004-	132088	25
CITROEN	C4 Grand Picasso (UA_) / 2.0 HDi 138	100 kW 1997 cc (RHJ-DW10BTED4)	10.2006-	132088	25
CITROEN	C4 Picasso (UD_) / 2.0 HDi 138	100 kW 1997 cc (RHJ-DW10BTED4)	02.2007-	132088	25
CITROEN	C5 (DC_) / 2.0 HDi	79 kW 1997 cc (RHS(DW10ATED))	03.2001-08.2004	132088	25
CITROEN	C5 (DC_) / 2.0 HDi (DCRHYB)	66 kW 1997 cc (RHY(DW10TD))	03.2001-08.2004	132088	25
CITROEN	C5 (DC_) / 2.0 HDi (DCRHZB, DCRHZE)	80 kW 1997 cc (RHZ(DW10ATED))	03.2001-08.2004	132088	25
CITROEN	C5 (DC_) / 2.2 HDi (DC4HXB, DC4HXE)	98 kW 2179 cc (4HX(DW12TED4/FAP))	03.2001-08.2004	132088	25
CITROEN	C5 (RC_) / 2.0 HDi (RCRHRH)	100 kW 1997 cc (DW10BTED4)	09.2004-	132088	25
CITROEN	C5 (RC_) / 2.2 HDi (RC4HXE)	98 kW 2179 cc (4HX(DW12TED4/FAP))	09.2004-	132088	25
CITROEN	C5 (RD_) / 2.0 HDi	100 kW 1997 cc (DW10BTED4)	02.2008-	132088	25
CITROEN	C5 Break (DE_) / 2.0 HDi	79 kW 1997 cc (RHS(DW10ATED))	06.2001-08.2004	132088	25
CITROEN	C5 Break (DE_) / 2.0 HDi	80 kW 1997 cc (RHZ(DW10ATED))	06.2001-08.2004	132088	25
CITROEN	C5 Break (DE_) / 2.0 HDi (DERHYB)	66 kW 1997 cc (RHY(DW10TD))	06.2001-08.2004	132088	25
CITROEN	C5 Break (DE_) / 2.2 HDi	98 kW 2179 cc (4HX(DW12TED4/FAP))	06.2001-08.2004	132088	25
CITROEN	C5 Break (RE_) / 2.0 HDi (RERHRH)	100 kW 1997 cc (RHR(DW10BTED4))	09.2004-	132088	25
CITROEN	C5 Break (RE_) / 2.2 HDi (RE4HXE)	98 kW 2179 cc (4HX(DW12TED4/FAP))	09.2004-	132088	25
CITROEN	C5 Break (TD_) / 2.0 HDi	100 kW 1997 cc (DW10BTED4)	02.2008-	132088	25
CITROEN	C5 Estate (DE_) / 2.0 HDi	79 kW 1997 cc	06.2001-08.2004	132088	25
CITROEN	C5 Estate (DE_) / 2.0 HDi	80 kW 1997 cc	06.2001-08.2004	132088	25
CITROEN	C5 Estate (DE_) / 2.0 HDi (DERHYB)	66 kW 1997 cc	06.2001-08.2004	132088	25
CITROEN	C5 Estate (DE_) / 2.2 HDi (DE4HXB)	98 kW 2179 cc	06.2001-08.2004	132088	25
CITROEN	C5 Stufenh. (RD_) / 2.0 HDi	100 kW 1997 cc	02.2008-	132088	25
CITROEN	C8 (EA_, EB_) / 2.0 HDi	79 kW 1997 cc (RHM(DW10ATED4))	07.2002-	132088	25
CITROEN	C8 (EA_, EB_) / 2.0 HDi	88 kW 1997 cc (RHK(DW10UTED4))	02.2007-	132088	25
CITROEN	C8 (EA_, EB_) / 2.0 HDi 135	100 kW 1997 cc (RHR(DW10BTED4))	03.2006-	132088	25
CITROEN	CX (MA) / 25 GTi Turbo 2	122 kW 1905 cc	06.1984-08.1985	132040	18
CITROEN	CX (MA) / 2500 D	55 kW 2500 cc	02.1978-06.1982	132050	26
CITROEN	CX I (MA) / 25 GTi Turbo 2	122 kW 2500 cc	06.1984-08.1985	132040	18
CITROEN	CX I (MA) / 2500 D	55 kW 2500 cc	02.1978-06.1982	132050	26
CITROEN	CX I Break (MA) / 2500 D	55 kW 2500 cc	02.1978-08.1985	132050	26
CITROEN	CX I Break (MA) / 2500 D Turbo	70 kW 2500 cc	04.1983-08.1985	132050	26
CITROEN	CX II / 25 D	54 kW 2500 cc	08.1985-12.1992	132050	26
CITROEN	CX II / 25 D Turbo	70 kW 2500 cc	08.1985-12.1986	132050	26
CITROEN	CX II / 25 D Turbo	88 kW 2500 cc	01.1987-12.1992	132050	26
CITROEN	CX II / 25 GTi	89 kW 1905 cc	05.1986-12.1992	132040	18



Modell
Model

Motor
Engine



Baujahr
Construction year

HÜCO-NO. Seite
Page

CITROEN	CX II / 25 GTi Turbo 2	115 kW 2500 cc	09.1986-12.1992	132040	18
CITROEN	CX II / 25 GTi Turbo 2	122 kW 2500 cc	08.1985-12.1992	132040	18
CITROEN	CX II / 25 TRI	100 kW 2500 cc	08.1985-12.1992	132040	18
CITROEN	CX II Break / 25 D	54 kW 2500 cc	05.1986-12.1992	132050	26
CITROEN	CX II Break / 25 D Turbo 2	88 kW 2500 cc	01.1987-12.1992	132050	26
CITROEN	CX II Break / 25 i	89 kW 2500 cc	05.1986-12.1992	132040	18
CITROEN	CX II Break / 25 TRI	100 kW 2500 cc	08.1985-12.1992	132040	18
CITROEN	CX Kombi (MA) / 2500 D	55 kW 2500 cc	02.1978-08.1985	132050	26
CITROEN	CX Kombi (MA) / 2500 D Turbo	70 kW 2500 cc	04.1983-08.1985	132050	26
CITROEN	CX Mk II / 25 D	54 kW 2500 cc	08.1985-12.1992	132050	26
CITROEN	CX Mk II / 25 D Turbo	70 kW 2500 cc	08.1985-12.1986	132050	26
CITROEN	CX Mk II / 25 D Turbo	88 kW 2500 cc	01.1987-12.1992	132050	26
CITROEN	CX Mk II / 25 GTi	89 kW 2500 cc	05.1986-12.1992	132040	18
CITROEN	CX Mk II / 25 GTi Turbo 2	115 kW 2500 cc	09.1986-12.1992	132040	18
CITROEN	CX Mk II / 25 GTi Turbo 2	122 kW 2500 cc	08.1985-12.1992	132040	18
CITROEN	CX Mk II / 25 TRI	100 kW 2500 cc	08.1985-12.1992	132040	18
CITROEN	CX Mk II Kombi / 25 D	54 kW 2500 cc	05.1986-12.1992	132050	26
CITROEN	CX Mk II Kombi / 25 D Turbo 2	88 kW 2500 cc	01.1987-12.1992	132050	26
CITROEN	CX Mk II Kombi / 25 i	89 kW 2500 cc	05.1986-12.1992	132040	18
CITROEN	CX Mk II Kombi / 25 TRI	100 kW 2500 cc	08.1985-12.1992	132040	18
CITROEN	DISPATCH / 1.9 TD	68 kW 1905 cc	10.1999-	132081	28
CITROEN	DISPATCH / 1.9 TD	68 kW 1905 cc (XUD9TE)	10.1999-	132088	25
CITROEN	DISPATCH / 2.0 HDi 110	80 kW 1997 cc (RHW(DW10ATED4))	12.2003-10.2006	132088	25
CITROEN	DISPATCH / 2.0 HDi 110 16V	80 kW 1997 cc (RHZ(DW10ATED))	12.2003-10.2006	132088	25
CITROEN	DISPATCH / 2.0 HDi 95	69 kW 1997 cc (RHX)	10.1999-	132088	25
CITROEN	DISPATCH (U6U) / 1.9 D	51 kW 1905 cc	10.1995-04.1998	132083	29
CITROEN	DISPATCH (U6U) / 1.9 D	51 kW 1905 cc (D9B(XUD9A/U))	10.1995-04.1998	132080	29
CITROEN	DISPATCH (U6U) / 1.9 D 70	51 kW 1868 cc (WJZ(DW8))	04.1998-	132088	25
CITROEN	DISPATCH (U6U) / 1.9 TD	66 kW 1905 cc (XUD9TE)	10.1995-	132081	28
CITROEN	DISPATCH (U6U) / 1.9 TD	68 kW 1905 cc	04.1996-	132081	28
CITROEN	DISPATCH (U6U) / 1.9 TD	68 kW 1905 cc (XUD9TE)	04.1996-	132088	25
CITROEN	DISPATCH (U6U) / 2.0 HDi 110	80 kW 1997 cc (RHW(DW10ATED4))	03.2000-	132088	25
CITROEN	DISPATCH (U6U) / 2.0 HDi 110	80 kW 1997 cc (RHZ(DW10ATED))	03.2000-	132088	25
CITROEN	DISPATCH (U6U) / 2.0 HDi 95	69 kW 1997 cc (RHX)	10.1999-	132088	25
CITROEN	DISPATCH / 2.0 HDi 120	88 kW 1997 cc (RHK(DW10UTED4))	01.2007-	132088	25
CITROEN	DISPATCH / 2.0 HDi 140	100 kW 1997 cc (RHR(DW10BTED4))	01.2007-	132088	25
CITROEN	DISPATCH Kasten / 2.0 HDi 120	88 kW 1997 cc (RHK(DW10UTED4))	01.2007-	132088	25
CITROEN	DISPATCH Kasten / 2.0 HDi 140	100 kW 1997 cc (RHR(DW10BTED4))	01.2007-	132088	25
CITROEN	DISPATCH Van / 1.9 D 70	51 kW 1868 cc (WJZ(DW8))	04.1998-	132088	25
CITROEN	DISPATCH Van / 1.9 TD	66 kW 1905 cc (XUD9TE)	10.1995-	132081	28
CITROEN	DISPATCH Van / 2.0 HDi 110	80 kW 1997 cc (RHW(DW10ATED4))	01.2002-	132088	25
CITROEN	DISPATCH Van / 2.0 HDi 110	80 kW 1997 cc (RHZ(DW10ATED))	01.2002-	132088	25
CITROEN	DISPATCH Van / 2.0 HDi 95	69 kW 1997 cc (RHX(DW10BTED))	10.1999-	132088	25
CITROEN	EVASION (22, U6) / 1.9 TD	66 kW 1905 cc	11.1994-07.2002	132081	28
CITROEN	EVASION (22, U6) / 1.9 TD	66 kW 1905 cc (XUD9TE)	11.1994-07.2002	132088	25
CITROEN	EVASION (22, U6) / 1.9 TD	68 kW 1905 cc (D8B(XUD9TF))	10.1995-12.1998	132088	25
CITROEN	EVASION (22, U6) / 2.0 HDi	80 kW 1997 cc (RHZ(DW10ATED))	08.1999-07.2002	132088	25
CITROEN	EVASION (22, U6) / 2.0 HDi 16V	80 kW 1997 cc (RHW(DW10ATED4))	09.1999-07.2002	132088	25
CITROEN	EVASION (22, U6) / 2.0 TD	68 kW 1998 cc	05.1997-07.2002	132081	28
CITROEN	EVASION (22, U6) / 2.1 TD	80 kW 2088 cc	05.1996-07.2002	132081	28
CITROEN	EVASION (22, U6) / 2.1 TD	80 kW 2088 cc (XUD11BTE)	05.1996-07.2002	132080	29
CITROEN	JUMPER Bus (230P) / 1.9 D	51 kW 1905 cc	01.1999-04.2002	132083	29
CITROEN	JUMPER Bus (230P) / 1.9 D	51 kW 1905 cc (D9B(XUD9A/U))	01.1999-04.2002	132080	29
CITROEN	JUMPER Bus (230P) / 2.5 D	63 kW 1905 cc	08.1994-04.2002	132085	30
CITROEN	JUMPER Bus (230P) / 2.5 D 4x4	63 kW 1700 cc	08.1996-04.2002	132085	30
CITROEN	JUMPER Bus (230P) / 2.5 TD	76 kW 1905 cc	08.1994-04.2002	132085	30
CITROEN	JUMPER Bus (230P) / 2.5 TD 4x4	76 kW 2446 cc	08.1996-04.2002	132085	30
CITROEN	JUMPER Bus (230P) / 2.5 TDi	79 kW 2500 cc	12.1996-11.2000	132085	30
CITROEN	JUMPER Bus (230P) / 2.5 TDi 4x4	79 kW 2446 cc	12.1996-11.2000	132085	30
CITROEN	JUMPER Bus (244, Z_) / 2.2 HDi	74 kW 2179 cc (DW12TED)	04.2002-	132088	25
CITROEN	JUMPER Bus / 2.2 HDi 100	74 kW 2198 cc (4HV)	04.2006-	132088	25
CITROEN	JUMPER Bus / 2.2 HDi 120	88 kW 2198 cc (4HU)	04.2006-	132088	25
CITROEN	JUMPER Kasten (230L) / 1.9 D	50 kW 1905 cc (DJY(XUD9A))	07.1999-04.2002	132080	29
CITROEN	JUMPER Kasten (230L) / 1.9 D	51 kW 1905 cc	02.1994-04.2002	132083	29
CITROEN	JUMPER Kasten (230L) / 1.9 D	51 kW 1905 cc (D9B(XUD9A/U))	02.1994-04.2002	132080	29
CITROEN	JUMPER Kasten (230L) / 1.9 TD	66 kW 1905 cc (XUD9TE)	03.1994-04.2002	132081	28
CITROEN	JUMPER Kasten (230L) / 2.5 D	63 kW 1905 cc	03.1994-04.2002	132085	30



Modell
Model

Motor
Engine



Baujahr
Construction year

HÜCO-NO. Seite
Page

	Modell Model	Motor Engine	Baujahr Construction year	HÜCO-NO.	Seite Page
CITROEN	JUMPER Kasten (230L) / 2.5 D 4x4	63 kW 2446 cc	03.2000-04.2002	132085	30
CITROEN	JUMPER Kasten (230L) / 2.5 TD	76 kW 2446 cc	03.1994-04.2002	132085	30
CITROEN	JUMPER Kasten (230L) / 2.5 TDi 4x4	79 kW 2446 cc	03.2000-11.2000	132085	30
CITROEN	JUMPER Kasten (244) / 2.2 HDi	74 kW 2179 cc (DW12TED)	04.2002-	132088	25
CITROEN	JUMPER Kasten / 2.2 HDi 100	74 kW 2198 cc (4HV)	04.2006-	132088	25
CITROEN	JUMPER Kasten / 2.2 HDi 120	88 kW 2198 cc (4HU)	04.2006-	132088	25
CITROEN	JUMPER Pritsche (230) / 1.9 TD	66 kW 1905 cc (XUD9TE)	03.1994-04.2002	132081	28
CITROEN	JUMPER Pritsche (230) / 2.5 D 4X4	63 kW 1769 cc	03.2000-04.2002	132085	30
CITROEN	JUMPER Pritsche (230) / 2.5 TD	76 kW 1608 cc	03.1994-04.2002	132085	30
CITROEN	JUMPER Pritsche (230) / 2.5 TDi	79 kW 1905 cc	12.1996-04.2002	132085	30
CITROEN	JUMPER Pritsche (230) / 2.5 TDi 4X4	79 kW 2446 cc	03.2000-04.2002	132085	30
CITROEN	JUMPER Pritsche (244) / 2.2 HDi 16V	74 kW 2179 cc (DW12TED)	04.2002-	132088	25
CITROEN	JUMPER Pritsche / 2.2 HDi 100	74 kW 2198 cc (4HV)	04.2006-	132088	25
CITROEN	JUMPER Pritsche / 2.2 HDi 120	88 kW 2198 cc (4HU)	04.2006-	132088	25
CITROEN	JUMPY / 1.9 TD	68 kW 1905 cc	10.1999-	132081	28
CITROEN	JUMPY / 1.9 TD	68 kW 1905 cc	10.1999-	132088	25
CITROEN	JUMPY / 2.0 HDi 110	80 kW 1997 cc	12.2003-10.2006	132088	25
CITROEN	JUMPY / 2.0 HDi 110 16V	80 kW 1997 cc	12.2003-10.2006	132088	25
CITROEN	JUMPY / 2.0 HDi 95	69 kW 1997 cc	10.1999-	132088	25
CITROEN	JUMPY (U6U) / 1.9 D	51 kW 1905 cc	10.1995-04.1998	132080	29
CITROEN	JUMPY (U6U) / 1.9 D	51 kW 1905 cc	10.1995-04.1998	132083	29
CITROEN	JUMPY (U6U) / 1.9 D 70	51 kW 1868 cc	04.1998-	132088	25
CITROEN	JUMPY (U6U) / 1.9 TD	66 kW 1905 cc	10.1995-	132081	28
CITROEN	JUMPY (U6U) / 1.9 TD	68 kW 1905 cc	04.1996-	132081	28
CITROEN	JUMPY (U6U) / 1.9 TD	68 kW 1905 cc	04.1996-	132088	25
CITROEN	JUMPY (U6U) / 2.0 HDi 110	80 kW 1997 cc	03.2000-	132088	25
CITROEN	JUMPY (U6U) / 2.0 HDi 95	69 kW 1997 cc	10.1999-	132088	25
CITROEN	JUMPY / 2.0 HDi 120	88 kW 1997 cc	01.2007-	132088	25
CITROEN	JUMPY / 2.0 HDi 140	100 kW 1997 cc	01.2007-	132088	25
CITROEN	JUMPY Kasten / 1.9 D 70	51 kW 1868 cc	04.1998-	132088	25
CITROEN	JUMPY Kasten / 1.9 TD	66 kW 1905 cc	10.1995-	132081	28
CITROEN	JUMPY Kasten / 2.0 HDi 110	80 kW 1997 cc	01.2002-	132088	25
CITROEN	JUMPY Kasten / 2.0 HDi 120	88 kW 1997 cc	01.2007-	132088	25
CITROEN	JUMPY Kasten / 2.0 HDi 140	100 kW 1997 cc	01.2007-	132088	25
CITROEN	JUMPY Kasten / 2.0 HDi 95	69 kW 1997 cc	10.1999-	132088	25
CITROEN	RELAY Bus (230P) / 1.9 D	51 kW 1905 cc	01.1999-04.2002	132080	29
CITROEN	RELAY Bus (230P) / 1.9 D	51 kW 1905 cc	01.1999-04.2002	132083	29
CITROEN	RELAY Bus (230P) / 2.5 D	63 kW 2446 cc	08.1994-04.2002	132085	30
CITROEN	RELAY Bus (230P) / 2.5 D 4x4	63 kW 2446 cc	08.1996-04.2002	132085	30
CITROEN	RELAY Bus (230P) / 2.5 TD	76 kW 2446 cc	08.1994-04.2002	132085	30
CITROEN	RELAY Bus (230P) / 2.5 TD 4x4	76 kW 2446 cc	08.1996-04.2002	132085	30
CITROEN	RELAY Bus (230P) / 2.5 TDi	79 kW 2446 cc	12.1996-11.2000	132085	30
CITROEN	RELAY Bus (230P) / 2.5 TDi 4x4	79 kW 2446 cc	12.1996-11.2000	132085	30
CITROEN	RELAY Bus (244, Z_) / 2.2 HDi	74 kW 2179 cc	04.2002-	132088	25
CITROEN	RELAY Bus / 2.2 HDi 100	74 kW 2198 cc	04.2006-	132088	25
CITROEN	RELAY Bus / 2.2 HDi 120	88 kW 2198 cc	04.2006-	132088	25
CITROEN	RELAY Kasten (230L) / 1.9 D	50 kW 1905 cc	07.1999-04.2002	132080	29
CITROEN	RELAY Kasten (230L) / 1.9 D	51 kW 1905 cc	02.1994-04.2002	132080	29
CITROEN	RELAY Kasten (230L) / 1.9 D	51 kW 1905 cc	02.1994-04.2002	132083	29
CITROEN	RELAY Kasten (230L) / 1.9 TD	66 kW 1905 cc	03.1994-04.2002	132081	28
CITROEN	RELAY Kasten (230L) / 2.5 D	63 kW 2446 cc	03.1994-04.2002	132085	30
CITROEN	RELAY Kasten (230L) / 2.5 D 4x4	63 kW 2446 cc	03.2000-04.2002	132085	30
CITROEN	RELAY Kasten (230L) / 2.5 TD	76 kW 2446 cc	03.1994-04.2002	132085	30
CITROEN	RELAY Kasten (230L) / 2.5 TDi 4x4	79 kW 2446 cc	03.2000-11.2000	132085	30
CITROEN	RELAY Kasten (244) / 2.2 HDi	74 kW 2179 cc	04.2002-	132088	25
CITROEN	RELAY Pritsche (230) / 1.9 TD	66 kW 1905 cc	03.1994-04.2002	132081	28
CITROEN	RELAY Pritsche (230) / 2.5 D 4X4	63 kW 2446 cc	03.2000-04.2002	132085	30
CITROEN	RELAY Pritsche (230) / 2.5 TD	76 kW 2446 cc	03.1994-04.2002	132085	30
CITROEN	RELAY Pritsche (230) / 2.5 TDi	79 kW 2446 cc	12.1996-04.2002	132085	30
CITROEN	RELAY Pritsche (230) / 2.5 TDi 4X4	79 kW 2446 cc	03.2000-04.2002	132085	30
CITROEN	RELAY Pritsche (244) / 2.2 HDi 16V	74 kW 2179 cc	04.2002-	132088	25
CITROEN	RELAY Pritsche / 2.2 HDi 100	74 kW 2198 cc	04.2006-	132088	25
CITROEN	RELAY Pritsche / 2.2 HDi 120	88 kW 2198 cc	04.2006-	132088	25
CITROEN	RELAY Van / 2.2 HDi 100	74 kW 2198 cc	04.2006-	132088	25
CITROEN	RELAY Van / 2.2 HDi 120	88 kW 2198 cc	04.2006-	132088	25
CITROEN	SYNERGIE (22, U6) / 1.9 TD	66 kW 1905 cc	11.1994-07.2002	132081	28
CITROEN	SYNERGIE (22, U6) / 1.9 TD	66 kW 1905 cc	11.1994-07.2002	132088	25



Modell
Model

Motor
Engine



Baujahr
Construction year

HÜCO-NO. Seite
Page

CITROEN	SYNERGIE (22, U6) / 1.9 TD	68 kW 1905 cc	10.1995-12.1998	132088	25
CITROEN	SYNERGIE (22, U6) / 2.0 HDI	80 kW 1997 cc	08.1999-07.2002	132088	25
CITROEN	SYNERGIE (22, U6) / 2.0 HDI 16V	80 kW 1997 cc	09.1999-07.2002	132088	25
CITROEN	SYNERGIE (22, U6) / 2.0 TD	68 kW 1998 cc	05.1997-07.2002	132081	28
CITROEN	SYNERGIE (22, U6) / 2.1 TD	80 kW 2088 cc	05.1996-07.2002	132080	29
CITROEN	SYNERGIE (22, U6) / 2.1 TD	80 kW 2088 cc	05.1996-07.2002	132081	28
CITROEN	VISA / 17 D	44 kW 1769 cc	04.1984-03.1991	132052	27
CITROEN	VISA / 17 D	44 kW 1769 cc	04.1984-03.1991	132080	29
CITROEN	VISA / 17 D	44 kW 1769 cc (161A(XUD7))	04.1984-03.1991	132051	26
CITROEN	XANTIA (X1) / 1.9 D	50 kW 1905 cc	06.1994-01.1998	132084	29
CITROEN	XANTIA (X1) / 1.9 D	50 kW 1905 cc (DJZ(XUD9Y))	06.1994-01.1998	132080	29
CITROEN	XANTIA (X1) / 1.9 D	51 kW 1905 cc	06.1994-01.1998	132083	29
CITROEN	XANTIA (X1) / 1.9 D	51 kW 1905 cc	06.1994-01.1998	132084	29
CITROEN	XANTIA (X1) / 1.9 D	51 kW 1905 cc	06.1994-01.1998	132085	30
CITROEN	XANTIA (X1) / 1.9 D	51 kW 1905 cc (D9B(XUD9A/L))	06.1994-01.1998	132080	29
CITROEN	XANTIA (X1) / 1.9 SD	55 kW 1905 cc	02.1996-01.1998	132081	28
CITROEN	XANTIA (X1) / 1.9 SD	55 kW 1905 cc (XUD9SD)	02.1996-01.1998	132088	25
CITROEN	XANTIA (X1) / 1.9 Turbo D	66 kW 1905 cc (XUD9TE)	10.1994-01.1998	132081	28
CITROEN	XANTIA (X1) / 2.1 Turbo D 12V	80 kW 2088 cc	06.1995-01.1998	132081	28
CITROEN	XANTIA (X1) / 2.1 Turbo D 12V	80 kW 2088 cc (XUD11BTE)	06.1995-01.1998	132080	29
CITROEN	XANTIA (X2) / 1.9 SD	55 kW 1905 cc	01.1998-04.2003	132081	28
CITROEN	XANTIA (X2) / 1.9 SD	55 kW 1905 cc (XUD9SD)	01.1998-04.2003	132088	25
CITROEN	XANTIA (X2) / 1.9 Turbo D	66 kW 1905 cc (XUD9TE)	01.1998-04.2003	132081	28
CITROEN	XANTIA (X2) / 2.0 HDI 109	80 kW 1997 cc (RHZ(DW10ATED))	02.1999-04.2003	132088	25
CITROEN	XANTIA (X2) / 2.0 HDI 90	66 kW 1997 cc (RHY(DW10TD))	03.1999-04.2003	132088	25
CITROEN	XANTIA (X2) / 2.1 Turbo D 12V	80 kW 2088 cc	01.1998-02.1999	132081	28
CITROEN	XANTIA (X2) / 2.1 Turbo D 12V	80 kW 2088 cc (XUD11BTE)	01.1998-02.1999	132080	29
CITROEN	XANTIA Break (X1) / 1.9 SD	55 kW 1905 cc	04.1997-01.1998	132081	28
CITROEN	XANTIA Break (X1) / 1.9 SD	55 kW 1905 cc (XUD9SD)	04.1997-01.1998	132088	25
CITROEN	XANTIA Break (X1) / 1.9 Turbo D	66 kW 1905 cc	06.1995-01.1998	132081	28
CITROEN	XANTIA Break (X1) / 1.9 Turbo D	66 kW 1905 cc (XUD9TE)	06.1995-01.1998	132088	25
CITROEN	XANTIA Break (X1) / 2.1 Turbo D 12V	80 kW 2088 cc	06.1996-01.1998	132081	28
CITROEN	XANTIA Break (X1) / 2.1 Turbo D 12V	80 kW 2088 cc (XUD11BTE)	06.1996-01.1998	132080	29
CITROEN	XANTIA Break (X2) / 1.9 SD	55 kW 1905 cc	01.1998-04.2003	132081	28
CITROEN	XANTIA Break (X2) / 1.9 SD	55 kW 1905 cc (XUD9SD)	01.1998-04.2003	132088	25
CITROEN	XANTIA Break (X2) / 1.9 Turbo D	66 kW 1905 cc	01.1998-04.2003	132081	28
CITROEN	XANTIA Break (X2) / 1.9 Turbo D	66 kW 1905 cc (XUD9TE)	01.1998-04.2003	132088	25
CITROEN	XANTIA Break (X2) / 2.0 HDI 109	80 kW 1997 cc (RHZ(DW10ATED))	02.1999-04.2003	132088	25
CITROEN	XANTIA Break (X2) / 2.0 HDI 90	66 kW 1997 cc (RHY(DW10TD))	03.1999-04.2003	132088	25
CITROEN	XANTIA Break (X2) / 2.1 Turbo D 12V	80 kW 2088 cc	01.1998-02.1999	132081	28
CITROEN	XANTIA Break (X2) / 2.1 Turbo D 12V	80 kW 2088 cc (XUD11BTE)	01.1998-02.1999	132080	29
CITROEN	XANTIA Estate (X1) / 1.9 SD	55 kW 1905 cc	04.1997-01.1998	132081	28
CITROEN	XANTIA Estate (X1) / 1.9 SD	55 kW 1905 cc	04.1997-01.1998	132088	25
CITROEN	XANTIA Estate (X1) / 1.9 Turbo D	66 kW 1905 cc	06.1995-01.1998	132081	28
CITROEN	XANTIA Estate (X1) / 1.9 Turbo D	66 kW 1905 cc	06.1995-01.1998	132088	25
CITROEN	XANTIA Estate (X1) / 2.1 Turbo D 12V	80 kW 2088 cc	06.1996-01.1998	132080	29
CITROEN	XANTIA Estate (X1) / 2.1 Turbo D 12V	80 kW 2088 cc	06.1996-01.1998	132081	28
CITROEN	XANTIA Estate (X2) / 1.9 SD	55 kW 1905 cc	01.1998-04.2003	132081	28
CITROEN	XANTIA Estate (X2) / 1.9 SD	55 kW 1905 cc	01.1998-04.2003	132088	25
CITROEN	XANTIA Estate (X2) / 1.9 Turbo D	66 kW 1905 cc	01.1998-04.2003	132081	28
CITROEN	XANTIA Estate (X2) / 1.9 Turbo D	66 kW 1905 cc	01.1998-04.2003	132088	25
CITROEN	XANTIA Estate (X2) / 2.0 HDI 109	80 kW 1997 cc	02.1999-04.2003	132088	25
CITROEN	XANTIA Estate (X2) / 2.0 HDI 90	66 kW 1997 cc	03.1999-04.2003	132088	25
CITROEN	XANTIA Estate (X2) / 2.1 Turbo D 12V	80 kW 2088 cc	01.1998-02.1999	132080	29
CITROEN	XANTIA Estate (X2) / 2.1 Turbo D 12V	80 kW 2088 cc	01.1998-02.1999	132081	28
CITROEN	XM (Y3) / 2.0	84 kW 1796 cc	05.1989-04.1994	132041	18
CITROEN	XM (Y3) / 2.0 i	89 kW 1990 cc	05.1989-06.1994	132041	18
CITROEN	XM (Y3) / 2.0 i Turbo	104 kW 1968 cc	09.1992-06.1994	132041	18
CITROEN	XM (Y3) / 2.1 D 12V	60 kW 2138 cc (P9A(XUD11A))	05.1989-06.1994	132080	29
CITROEN	XM (Y3) / 2.1 TD 12V	80 kW 2088 cc (PJZ(XUD11ATE))	05.1989-06.1994	132080	29
CITROEN	XM (Y4) / 2.0 Turbo	108 kW 1998 cc	05.1994-10.2000	132041	18
CITROEN	XM (Y4) / 2.1 D12 VSX	60 kW 2138 cc (P9A(XUD11A))	03.1996-08.1996	132080	29
CITROEN	XM (Y4) / 2.1 TD 12V	80 kW 2088 cc	05.1994-10.2000	132081	28
CITROEN	XM (Y4) / 2.1 TD 12V	80 kW 2088 cc (XUD11BTE)	05.1994-10.2000	132080	29
CITROEN	XM (Y4) / 2.5 TD	95 kW 2446 cc (THY(DK5ATE))	05.1994-10.2000	132088	25
CITROEN	XM Break (Y3) / 2.0 i	89 kW 2088 cc	11.1991-04.1994	132041	18
CITROEN	XM Break (Y3) / 2.0 i (Y3A)	79 kW 1993 cc	11.1991-04.1994	132041	18



Modell
Model

Motor
Engine



Baujahr
Construction year

HÜCO-NO. Seite
Page

	Modell Model	Motor Engine	Baujahr Construction year	HÜCO-NO.	Seite Page
CITROEN	XM Break (Y3) / 2.0 Turbo	104 kW 1968 cc	09.1992-04.1994	132041	18
CITROEN	XM Break (Y3) / 2.1 D 12V	60 kW 2138 cc (P9A(XUD11A))	11.1991-04.1994	132080	29
CITROEN	XM Break (Y3) / 2.1 TD 12V	80 kW 2088 cc (P8A(XUD11ATE))	11.1991-04.1994	132080	29
CITROEN	XM Break (Y4) / 2.0 i 16V	97 kW 2446 cc	05.1994-10.2000	132041	18
CITROEN	XM Break (Y4) / 2.0 Turbo	108 kW 1998 cc	05.1994-10.2000	132041	18
CITROEN	XM Break (Y4) / 2.1 D12	60 kW 2138 cc (P9A(XUD11A))	07.1994-06.1996	132080	29
CITROEN	XM Break (Y4) / 2.1 TD 12V	80 kW 2088 cc	05.1994-10.2000	132081	28
CITROEN	XM Break (Y4) / 2.1 TD 12V	80 kW 2088 cc (XUD11BTE)	05.1994-10.2000	132080	29
CITROEN	XM Break (Y4) / 2.5 TD	95 kW 2446 cc (THY(DK5ATE))	05.1994-10.2000	132088	25
CITROEN	XM Estate (Y3) / 2.0 i	89 kW 1998 cc	11.1991-04.1994	132041	18
CITROEN	XM Estate (Y3) / 2.0 i (Y3A)	79 kW 1998 cc	11.1991-04.1994	132041	18
CITROEN	XM Estate (Y3) / 2.0 Turbo	104 kW 1998 cc	09.1992-04.1994	132041	18
CITROEN	XM Estate (Y3) / 2.1 D 12V	60 kW 2138 cc	11.1991-04.1994	132080	29
CITROEN	XM Estate (Y3) / 2.1 TD 12V	80 kW 2088 cc	11.1991-04.1994	132080	29
CITROEN	XM Estate (Y4) / 2.0 i 16V	97 kW 1998 cc	05.1994-10.2000	132041	18
CITROEN	XM Estate (Y4) / 2.0 Turbo	108 kW 1998 cc	05.1994-10.2000	132041	18
CITROEN	XM Estate (Y4) / 2.1 D12	60 kW 2138 cc	07.1994-06.1996	132080	29
CITROEN	XM Estate (Y4) / 2.1 TD 12V	80 kW 2088 cc	05.1994-10.2000	132080	29
CITROEN	XM Estate (Y4) / 2.1 TD 12V	80 kW 2088 cc	05.1994-10.2000	132081	28
CITROEN	XM Estate (Y4) / 2.5 TD	95 kW 2446 cc	05.1994-10.2000	132088	25
CITROEN	XSARA (N1) / 1.5 D	42 kW 2792 cc	04.1997-09.2000	132085	30
CITROEN	XSARA (N1) / 1.8 D	43 kW 1769 cc	04.1997-09.2000	132085	30
CITROEN	XSARA (N1) / 1.8 D	43 kW 1769 cc (161A(XUD7))	04.1997-09.2000	132080	29
CITROEN	XSARA (N1) / 1.8 TD	66 kW 2874 cc	10.1997-09.2000	132085	30
CITROEN	XSARA (N1) / 1.9 D	50 kW 1905 cc	04.1997-09.2000	132085	30
CITROEN	XSARA (N1) / 1.9 D	50 kW 1905 cc (DJY(XUD9A))	04.1997-09.2000	132080	29
CITROEN	XSARA (N1) / 1.9 D	51 kW 1868 cc (WJZ(DW8))	07.1998-03.2005	132088	25
CITROEN	XSARA (N1) / 1.9 SD	55 kW 1905 cc (XUD9BSD)	01.1998-09.2000	132081	28
CITROEN	XSARA (N1) / 1.9 TD	66 kW 1905 cc (XUD9TE)	04.1997-09.2000	132081	28
CITROEN	XSARA (N1) / 2.0 HDi 109	80 kW 1997 cc (RHZ(DW10ATED))	05.2001-03.2005	132088	25
CITROEN	XSARA (N1) / 2.0 HDi 90	66 kW 1997 cc (RHY(DW10TD))	02.1999-03.2005	132088	25
CITROEN	XSARA Break (N2) / 1.5 D	42 kW 1769 cc	10.1997-09.2000	132085	30
CITROEN	XSARA Break (N2) / 1.8 D	43 kW 1769 cc	10.1997-09.2000	132085	30
CITROEN	XSARA Break (N2) / 1.8 D	43 kW 1769 cc (A9A(XUD7))	10.1997-09.2000	132080	29
CITROEN	XSARA Break (N2) / 1.9 D	50 kW 1905 cc (DJY(XUD9A))	10.1997-09.2000	132080	29
CITROEN	XSARA Break (N2) / 1.9 D	51 kW 1868 cc (WJY(DW8B))	07.1998-08.2005	132088	25
CITROEN	XSARA Break (N2) / 1.9 D	55 kW 1905 cc (XUD9BSD)	01.1998-09.2000	132081	28
CITROEN	XSARA Break (N2) / 1.9 TD	66 kW 1905 cc (XUD9TE)	10.1997-09.2000	132081	28
CITROEN	XSARA Break (N2) / 2.0 HDi 109	80 kW 1997 cc (RHZ(DW10ATED))	05.2001-08.2005	132088	25
CITROEN	XSARA Break (N2) / 2.0 HDi 90	66 kW 1997 cc (RHY(DW10TD))	02.1999-08.2005	132088	25
CITROEN	XSARA Coupe (N0) / 1.9 D	50 kW 1905 cc (DJY(XUD9A))	02.1998-09.2000	132080	29
CITROEN	XSARA Coupe (N0) / 1.9 D	51 kW 1868 cc (WJZ(DW8))	02.1999-03.2005	132088	25
CITROEN	XSARA Coupe (N0) / 1.9 TD	66 kW 1905 cc (XUD9TE)	02.1998-09.2000	132081	28
CITROEN	XSARA Coupe (N0) / 2.0 HDi 109	80 kW 1997 cc (RHZ(DW10ATED))	05.2001-03.2005	132088	25
CITROEN	XSARA Coupe (N0) / 2.0 HDi 90	66 kW 1997 cc (RHY(DW10TD))	02.1999-03.2005	132088	25
CITROEN	XSARA Estate (N2) / 1.5 D	42 kW 1527 cc	10.1997-09.2000	132085	30
CITROEN	XSARA Estate (N2) / 1.8 D	43 kW 1769 cc	10.1997-09.2000	132080	29
CITROEN	XSARA Estate (N2) / 1.8 D	43 kW 1769 cc	10.1997-09.2000	132085	30
CITROEN	XSARA Estate (N2) / 1.9 D	50 kW 1905 cc	10.1997-09.2000	132080	29
CITROEN	XSARA Estate (N2) / 1.9 D	51 kW 1868 cc	07.1998-08.2005	132088	25
CITROEN	XSARA Estate (N2) / 1.9 D	55 kW 1905 cc	01.1998-09.2000	132081	28
CITROEN	XSARA Estate (N2) / 1.9 TD	66 kW 1905 cc	10.1997-09.2000	132081	28
CITROEN	XSARA Estate (N2) / 2.0 HDi 109	80 kW 1997 cc	05.2001-08.2005	132088	25
CITROEN	XSARA Estate (N2) / 2.0 HDi 90	66 kW 1997 cc	02.1999-08.2005	132088	25
CITROEN	XSARA PICASSO (N68) / 2.0 HDi	66 kW 1997 cc (RHY(DW10TD))	12.1999-	132088	25
CITROEN	ZX (N2) / 1.4 D	37 kW 1360 cc	07.1994-10.1997	132080	29
CITROEN	ZX (N2) / 1.8 D	44 kW 1769 cc	06.1993-06.1997	132083	29
CITROEN	ZX (N2) / 1.8 D	44 kW 1769 cc (XUD7)	06.1993-06.1997	132080	29
CITROEN	ZX (N2) / 1.9 D	47 kW 1905 cc (DJZ(XUD9Y))	03.1991-06.1997	132080	29
CITROEN	ZX (N2) / 1.9 D	50 kW 1905 cc	06.1994-06.1997	132083	29
CITROEN	ZX (N2) / 1.9 D	50 kW 1905 cc (D9B(XUD9A/U))	06.1994-06.1997	132080	29
CITROEN	ZX (N2) / 1.9 TD	66 kW 1905 cc (XUD9TE)	07.1992-06.1997	132081	28
CITROEN	ZX Break (N2) / 1.8 D	44 kW 1769 cc	10.1993-10.1997	132083	29
CITROEN	ZX Break (N2) / 1.8 D	44 kW 1769 cc (XUD7)	10.1993-10.1997	132080	29
CITROEN	ZX Break (N2) / 1.9 D	47 kW 1905 cc	10.1993-10.1997	132084	29
CITROEN	ZX Break (N2) / 1.9 D	47 kW 1905 cc (DJZ(XUD9Y))	10.1993-10.1997	132080	29
CITROEN	ZX Break (N2) / 1.9 D	50 kW 1905 cc	06.1994-10.1997	132083	29



Modell
Model

Motor
Engine



Baujahr
Construction year

HÜCO-NO. Seite
Page

	Modell Model	Motor Engine	Baujahr Construction year	HÜCO-NO.	Seite Page
CITROEN	ZX Break (N2) / 1.9 D	50 kW 1905 cc (D9B(XUD9A/U))	06.1994-10.1997	132080	29
CITROEN	ZX Break (N2) / 1.9 TD	66 kW 1905 cc (XUD9TE)	10.1993-10.1997	132081	28
CITROEN	ZX Estate (N2) / 1.8 D	44 kW 1769 cc	10.1993-10.1997	132080	29
CITROEN	ZX Estate (N2) / 1.8 D	44 kW 1769 cc	10.1993-10.1997	132083	29
CITROEN	ZX Estate (N2) / 1.9 D	47 kW 1905 cc	10.1993-10.1997	132080	29
CITROEN	ZX Estate (N2) / 1.9 D	47 kW 1905 cc	10.1993-10.1997	132084	29
CITROEN	ZX Estate (N2) / 1.9 D	50 kW 1905 cc	06.1994-10.1997	132080	29
CITROEN	ZX Estate (N2) / 1.9 D	50 kW 1905 cc	06.1994-10.1997	132083	29
CITROEN	ZX Estate (N2) / 1.9 TD	66 kW 1905 cc	10.1993-10.1997	132081	28
DACIA	1310 Stufenh. (U, X) / 1.9 D	48 kW 1870 cc (F8Q630)	02.2005-	132079	31
DACIA	SOLENZA / 1.9 D	46 kW 1870 cc (F8Q630)	02.2003-	132079	31
FERRARI	MONDIAL / 3.2 quat.valvole	199 kW 2927 cc	10.1985-12.1988	132040	18
FERRARI	MONDIAL / 3.4 T	221 kW 3186 cc	03.1989-12.1993	132040	18
FERRARI	MONDIAL / 8	158 kW 1272 cc	07.1980-09.1983	132040	18
FERRARI	MONDIAL / 8 quat.valvole	177 kW 2927 cc	10.1982-07.1987	132040	18
FERRARI	MONDIAL Cabriolet / 3.2 quat.valvole	199 kW 3186 cc	09.1985-12.1988	132040	18
FERRARI	MONDIAL Cabriolet / 3.4 T	221 kW 3405 cc	01.1989-12.1993	132040	18
FERRARI	MONDIAL Cabriolet / 8 quat.valvole	177 kW 2927 cc	03.1984-07.1987	132040	18
FIAT	127 / 1.3 D	33 kW 1301 cc (127A5.000)	04.1981-12.1986	132053	27
FIAT	127 Panorama / 1.3 D	33 kW 1301 cc (127A5.000)	06.1981-12.1986	132053	27
FIAT	131 / 2.0 D	44 kW 1995 cc	07.1978-08.1984	132051	26
FIAT	131 / 2.0 D	44 kW 1995 cc	07.1978-08.1984	132052	27
FIAT	131 / 2.5 D	53 kW 1929 cc	06.1978-02.1984	132051	26
FIAT	131 / 2.5 D	53 kW 2445 cc	06.1978-02.1984	132052	27
FIAT	131 Familiare/Panorama / 2.0 D	44 kW 1994 cc	07.1978-08.1984	132051	26
FIAT	131 Familiare/Panorama / 2.0 D	44 kW 1995 cc	07.1978-08.1984	132052	27
FIAT	131 Familiare/Panorama / 2.5 Super D	53 kW 2445 cc	03.1979-12.1984	132052	27
FIAT	131 Familiare/Panorama / 2.5 Super D	53 kW 2446 cc	03.1979-12.1984	132051	26
FIAT	147 / 1.3 D	33 kW 1301 cc (127A5.000)	07.1982-07.1983	132053	27
FIAT	147 Panorama / 1.3 D	33 kW 1301 cc (127A5.000)	07.1982-07.1983	132053	27
FIAT	500 / 1.2 LPG	51 kW 1998 cc	12.2010-	132045	23
FIAT	ALBEA (178_) / 1.7 D	52 kW 1697 cc (01033)	03.2002-	132082	29
FIAT	ALBEA (178_) / 1.7 TD	51 kW 1697 cc (01033)	02.2006-	132082	29
FIAT	BRAVA (182) / 1.9 TD 75 S (182.BF)	55 kW 1905 cc	03.1996-10.2001	132082	29
FIAT	BRAVO I (182) / 1.9 TD 75 S (182.AF)	55 kW 1910 cc	03.1996-10.2001	132082	29
FIAT	CROMA (154) / 2000 16V	101 kW 1781 cc	08.1992-08.1996	132040	18
FIAT	CROMA (154) / 2000 CHT (154.AC)	66 kW 1975 cc	12.1985-02.1989	132040	18
FIAT	CROMA (154) / 2000 i.e.	85 kW 2986 cc	10.1987-08.1996	132040	18
FIAT	CROMA (154) / 2000 i.e. (154.AD)	88 kW 1995 cc	03.1987-09.1992	132040	18
FIAT	CROMA (154) / 2000 i.e. (154.AM)	83 kW 1995 cc	03.1986-09.1990	132040	18
FIAT	CROMA (154) / 2000 i.e. Turbo	110 kW 1995 cc	06.1987-08.1996	132040	18
FIAT	CROMA (154) / 2000 i.e. Turbo	111 kW 2445 cc	11.1986-11.1988	132040	18
FIAT	CROMA (154) / 2000 i.e. Turbo (154.AM)	114 kW 1995 cc	12.1985-06.1990	132040	18
FIAT	DUCATO Bus (230) / 1.9 D	50 kW 1905 cc (D9B(XUD9A))	04.1998-04.2002	132080	29
FIAT	DUCATO Bus (230) / 1.9 TD	66 kW 1905 cc (DHX(XUD9TF/L))	04.1998-04.2002	132081	28
FIAT	DUCATO Bus (230) / 2.0 JTD	62 kW 1997 cc (RHV(DW10))	10.2001-04.2002	132088	25
FIAT	DUCATO Bus (230) / 2.5 D Combinato	62 kW 2446 cc	08.1994-04.2002	132051	26
FIAT	DUCATO Bus (230) / 2.5 D Combinato	62 kW 2500 cc	08.1994-04.2002	132052	27
FIAT	DUCATO Bus (244, Z_) / 2.0 JTD	62 kW 1997 cc (RHV(DW10))	04.2002-	132088	25
FIAT	DUCATO Bus (250) / 100 Multijet 2,2 D	74 kW 2198 cc (4HV)	07.2006-	132088	25
FIAT	DUCATO Kasten / 100 Multijet 2,2 D	74 kW 2198 cc (4HV)	07.2006-	132088	25
FIAT	DUCATO Kasten (230L) / 1.9 TD	66 kW 1905 cc (DHX(XUD9TF/L))	04.1998-04.2002	132081	28
FIAT	DUCATO Kasten (230L) / 2.0 JTD	62 kW 1997 cc (RHV(DW10))	10.2001-04.2002	132088	25
FIAT	DUCATO Kasten (230L) / 2.5 D	62 kW 1905 cc	03.1994-04.2002	132051	26
FIAT	DUCATO Kasten (230L) / 2.5 D	62 kW 2500 cc	03.1994-04.2002	132052	27
FIAT	DUCATO Kasten (244) / 2.0 JTD	62 kW 1997 cc (RHV(DW10))	04.2002-	132088	25
FIAT	DUCATO Kasten (280) / 2.5 D	55 kW 2445 cc	01.1982-08.1990	132051	26
FIAT	DUCATO Kasten (280) / 2.5 D	55 kW 2500 cc	01.1982-08.1990	132052	27
FIAT	DUCATO Kasten (280) / 2.5 D 4x4	55 kW 1986 cc	03.1989-08.1990	132051	26
FIAT	DUCATO Kasten (280) / 2.5 D 4x4	55 kW 2500 cc	03.1989-08.1990	132052	27
FIAT	DUCATO Kasten (290) / 2.5 D 4x4	55 kW 2500 cc	07.1990-03.1994	132051	26
FIAT	DUCATO Kasten (290) / 2.5 D 4x4	55 kW 2500 cc	07.1990-03.1994	132052	27
FIAT	DUCATO Kasten (290) / 2.5 TD	70 kW 2500 cc	07.1990-03.1994	132051	26
FIAT	DUCATO Kasten (290) / 2.5 TD	70 kW 2500 cc	07.1990-03.1994	132052	27
FIAT	DUCATO Kasten (290) / 2.5 TD 4x4	70 kW 2500 cc	07.1990-03.1994	132051	26
FIAT	DUCATO Kasten (290) / 2.5 TD 4x4	70 kW 2500 cc	07.1990-03.1994	132052	27
FIAT	DUCATO Panorama (280) / 2.4 D	53 kW 1588 cc	07.1982-12.1985	132051	26



Modell
Model

Motor
Engine



Baujahr
Construction year

HÜCO-NO. Seite
Page

	Modell Model	Motor Engine	Baujahr Construction year	HÜCO-NO.	Seite Page
FIAT	DUCATO Panorama (280) / 2.4 D	53 kW 2428 cc	07.1982-12.1985	132052	27
FIAT	DUCATO Panorama (280) / 2.4 TD	68 kW 2445 cc	01.1987-08.1990	132052	27
FIAT	DUCATO Panorama (280) / 2.4 TD	68 kW 2500 cc	01.1987-08.1990	132051	26
FIAT	DUCATO Panorama (280) / 2.4 TD 4x4	68 kW 2445 cc	01.1986-08.1990	132051	26
FIAT	DUCATO Panorama (280) / 2.4 TD 4x4	68 kW 2445 cc	01.1986-08.1990	132052	27
FIAT	DUCATO Panorama (280) / 2.5 D	55 kW 2445 cc	01.1986-08.1990	132051	26
FIAT	DUCATO Panorama (280) / 2.5 D	55 kW 2500 cc	01.1986-08.1990	132052	27
FIAT	DUCATO Panorama (280) / 2.5 D 4x4	55 kW 1698 cc	01.1987-08.1990	132051	26
FIAT	DUCATO Panorama (280) / 2.5 D 4x4	55 kW 2500 cc	01.1987-08.1990	132052	27
FIAT	DUCATO Panorama (290) / 2.5 D	55 kW 2500 cc	07.1990-03.1994	132051	26
FIAT	DUCATO Panorama (290) / 2.5 D	55 kW 2500 cc	07.1990-03.1994	132052	27
FIAT	DUCATO Panorama (290) / 2.5 D 4x4	55 kW 2500 cc	07.1990-03.1994	132051	26
FIAT	DUCATO Panorama (290) / 2.5 D 4x4	55 kW 2500 cc	07.1990-03.1994	132052	27
FIAT	DUCATO Panorama (290) / 2.5 TD	70 kW 2500 cc	08.1990-03.1994	132051	26
FIAT	DUCATO Panorama (290) / 2.5 TD	70 kW 2500 cc	08.1990-03.1994	132052	27
FIAT	DUCATO Panorama (290) / 2.5 TD 4x4	70 kW 2500 cc	01.1991-03.1994	132051	26
FIAT	DUCATO Panorama (290) / 2.5 TD 4x4	70 kW 2500 cc	01.1991-03.1994	132052	27
FIAT	DUCATO Pritsche (230) / 1.9 TD	66 kW 1905 cc (DHX(XUD9TF/L))	04.1998-04.2002	132081	28
FIAT	DUCATO Pritsche (230) / 2.5 D	62 kW 1781 cc	03.1994-04.2002	132051	26
FIAT	DUCATO Pritsche (230) / 2.5 D	62 kW 2500 cc	03.1994-04.2002	132052	27
FIAT	DUCATO Pritsche (230) / 2.5 D 4x4	62 kW 1753 cc	03.1994-04.2002	132051	26
FIAT	DUCATO Pritsche (230) / 2.5 D 4x4	62 kW 2500 cc	03.1994-04.2002	132052	27
FIAT	DUCATO Pritsche (244) / 2.0 JTD	62 kW 1997 cc (RHV(DW10))	04.2002-	132088	25
FIAT	DUCATO Pritsche (250) / 2,2 D	74 kW 2198 cc (4HV)	07.2006-	132088	25
FIAT	DUCATO Pritsche (280) / 2.4 TD	68 kW 2445 cc	01.1986-08.1990	132052	27
FIAT	DUCATO Pritsche (280) / 2.4 TD	68 kW 3453 cc	01.1986-08.1990	132051	26
FIAT	DUCATO Pritsche (280) / 2.5 D	55 kW 2500 cc	07.1982-08.1990	132051	26
FIAT	DUCATO Pritsche (280) / 2.5 D	55 kW 2500 cc	07.1982-08.1990	132052	27
FIAT	DUCATO Pritsche (280) / 2.5 D 4x4	55 kW 2500 cc	03.1989-08.1990	132051	26
FIAT	DUCATO Pritsche (280) / 2.5 D 4x4	55 kW 2500 cc	03.1989-08.1990	132052	27
FIAT	DUCATO Pritsche (290) / 2.5 D	55 kW 2500 cc	07.1990-03.1994	132051	26
FIAT	DUCATO Pritsche (290) / 2.5 D	55 kW 2500 cc	07.1990-03.1994	132052	27
FIAT	DUCATO Pritsche (290) / 2.5 D 4x4	55 kW 2500 cc	07.1990-03.1994	132051	26
FIAT	DUCATO Pritsche (290) / 2.5 D 4x4	55 kW 2500 cc	07.1990-03.1994	132052	27
FIAT	DUCATO Pritsche (290) / 2.5 TD	70 kW 1905 cc	07.1990-03.1994	132051	26
FIAT	DUCATO Pritsche (290) / 2.5 TD	70 kW 2500 cc	07.1990-03.1994	132052	27
FIAT	DUCATO Pritsche (290) / 2.5 TD 4x4	70 kW 2500 cc	07.1990-03.1994	132051	26
FIAT	DUCATO Pritsche (290) / 2.5 TD 4x4	70 kW 2500 cc	07.1990-03.1994	132052	27
FIAT	DUNA (146 B) / DS 1.7	44 kW 1698 cc (149B3.000)	01.1987-12.1991	132053	27
FIAT	DUNA Weekend (146 B) / DS 1.7	44 kW 1698 cc (149B3.000)	01.1987-12.1991	132053	27
FIAT	ELBA (146_) / 1.3 D	33 kW 1301 cc (127A5.000)	04.1986-10.1992	132053	27
FIAT	ELBA (146_) / 1.7 D	43 kW 1698 cc (146B2.000)	04.1989-12.1996	132053	27
FIAT	FIORINO (147) / 1.3 D	33 kW 1288 cc (127A5.000)	03.1982-12.1987	132053	27
FIAT	FIORINO (147) / 1.7 D	42 kW 1288 cc	01.1988-	132053	27
FIAT	FIORINO (147) / 1.7 D	44 kW 1698 cc (149B3.000)	12.1987-12.1990	132053	27
FIAT	FIORINO Kasten (146 Uno) / 1.7 D	44 kW 1697 cc (146B2.000)	01.1988-10.1999	132053	27
FIAT	FIORINO Kasten (146 Uno) / 60 1.7 D	42 kW 1697 cc (146B2.000)	05.1988-10.1996	132053	27
FIAT	FIORINO Kasten (146 Uno) / 60 1.7 D	44 kW 1698 cc (149B3.000)	05.1988-05.2000	132053	27
FIAT	FIORINO Kasten (146 Uno) / 65 1.7 TD	46 kW 1698 cc	01.1997-05.2001	132082	29
FIAT	FIORINO Pick up (146) / 1.7 D	42 kW 1697 cc (146B2.000)	10.1993-10.1999	132053	27
FIAT	FIORINO Pick up (146) / 1.7 D	44 kW 1698 cc (149B3.000)	05.1988-10.1999	132053	27
FIAT	FIORINO Pick up (146) / 1.7 TD	46 kW 1697 cc	01.1997-05.2001	132082	29
FIAT	FIORINO Pick up (147) / 1.3 D	33 kW 1302 cc (127A5.000)	05.1984-12.1988	132053	27
FIAT	MAREA (185) / 1.9 TD 75	55 kW 1781 cc	09.1996-	132082	29
FIAT	MAREA Weekend (185) / 1.9 TD 75	55 kW 1781 cc	09.1996-	132082	29
FIAT	PALIO (178BX) / 1.7 TD	53 kW 1697 cc (01033)	09.2001-	132082	29
FIAT	PALIO Weekend (178DX) / 1.7 TD	51 kW 2792 cc	04.1996-03.2001	132082	29
FIAT	PALIO Weekend (178DX) / 1.7 TD	59 kW 1698 cc (01035)	06.2001-12.2003	132082	29
FIAT	PANDA (141A_) / 1300 D	27 kW 1302 cc (156A5.000)	04.1986-12.1992	132053	27
FIAT	PETRA (178_) / 1.7 D	52 kW 1697 cc	03.2002-	132082	29
FIAT	PETRA (178_) / 1.7 TD	51 kW 1697 cc	02.2006-	132082	29
FIAT	PR MIO (146 B) / DS 1.7	44 kW 1698 cc	01.1987-12.1991	132053	27
FIAT	PR MIO Kombi (146 B) / DS 1.7	44 kW 1698 cc	01.1987-12.1991	132053	27
FIAT	PUNTO (176) / 1.7 D	42 kW 1968 cc	04.1994-09.1997	132082	29
FIAT	PUNTO (176) / 1.7 TD	51 kW 1698 cc	01.1994-09.1999	132082	29
FIAT	PUNTO (176) / 1.7 TD	52 kW 2500 cc	01.1994-09.1999	132082	29
FIAT	PUNTO (176) / 60 TD 1.7	46 kW 2446 cc	09.1996-09.1999	132082	29



	Modell Model	Motor Engine	Baujahr Construction year	HÜCO-NO.	Seite Page
FIAT	PUNTO Van (176L) / 1.7 D	42 kW 2792 cc	04.1996-02.2000	132082	29
FIAT	PUNTO Van (176L) / 1.7 TD	52 kW 2874 cc	04.1996-02.2000	132082	29
FIAT	REGATA (138) / 60 D 1.7	43 kW 1714 cc (138B6.000)	09.1983-12.1986	132053	27
FIAT	REGATA (138) / 60 D 1.7	44 kW 1698 cc (149B3.000)	05.1985-03.1989	132053	27
FIAT	REGATA (138) / 65 D	48 kW 1929 cc (149A1.000)	04.1984-07.1989	132053	27
FIAT	REGATA (138) / 65 D 1.9	48 kW 1929 cc	04.1984-07.1989	132053	27
FIAT	REGATA (138) / 80 Turbo D. 1.9	59 kW 1929 cc (831D1.000)	05.1986-07.1989	132053	27
FIAT	REGATA Stufenh. 80 Turbo D. 1.9	59 kW 1929 cc	05.1986-07.1989	132053	27
FIAT	REGATA Stufenh. (138) / 60 D 1.7	43 kW 1714 cc	09.1983-12.1986	132053	27
FIAT	REGATA Stufenh. (138) / 60 D 1.7	44 kW 1698 cc	05.1985-03.1989	132053	27
FIAT	REGATA Stufenh. (138) / 65 D	48 kW 1929 cc	04.1984-07.1989	132053	27
FIAT	REGATA Stufenh. (138) / 65 D 1.9	48 kW 1929 cc	04.1984-07.1989	132053	27
FIAT	REGATA Weekend / 60 D 1.7	44 kW 1698 cc (149B3.000)	01.1984-12.1989	132053	27
FIAT	REGATA Weekend / 65 D 1.9	48 kW 1929 cc (149A1.000)	04.1984-07.1989	132053	27
FIAT	REGATA Weekend / 80 Turbo D. 1.9	59 kW 1929 cc (831D1.000)	05.1986-07.1989	132053	27
FIAT	RITMO II (138A) / 60 D 1.7	43 kW 1714 cc (138B6.000)	10.1982-10.1985	132053	27
FIAT	RITMO II (138A) / 60 D 1.7	44 kW 1698 cc (149B3.000)	05.1985-12.1987	132053	27
FIAT	RITMO II (138A) / 80 Turbo D. 1.9	59 kW 1929 cc (831D1.000)	12.1985-12.1987	132053	27
FIAT	RITMO Mk II (138A) / 60 D 1.7	43 kW 1714 cc	10.1982-10.1985	132053	27
FIAT	RITMO Mk II (138A) / 60 D 1.7	44 kW 1698 cc	05.1985-12.1987	132053	27
FIAT	RITMO Mk II (138A) / 80 Turbo D. 1.9	59 kW 1929 cc	12.1985-12.1987	132053	27
FIAT	SCUDO (270_) / 2.0 D Multijet	100 kW 1997 cc (RHR)	01.2007-	132088	25
FIAT	SCUDO (270_) / 2.0 D Multijet	88 kW 1997 cc (RHK)	01.2007-	132088	25
FIAT	SCUDO Combinato (220P) / 1.9 D	51 kW 1868 cc (WJZ(DW8))	04.1998-	132088	25
FIAT	SCUDO Combinato (220P) / 1.9 D	51 kW 1905 cc	02.1996-04.1998	132083	29
FIAT	SCUDO Combinato (220P) / 1.9 TD Eco	66 kW 1905 cc (DHX(XUD9TF/L))	02.1996-	132081	28
FIAT	SCUDO Combinato (220P) / 2.0 JTD	69 kW 1997 cc (RHX)	01.2004-	132088	25
FIAT	SCUDO Combinato (220P) / 2.0 JTD	80 kW 1997 cc (RHZ)	12.1999-	132088	25
FIAT	SCUDO Combinato (220P) / 2.0 JTD 16V	80 kW 1997 cc (RHW(DW10ATED4))	05.1999-12.2006	132088	25
FIAT	SCUDO Kasten (220L) / 1.9 D	51 kW 1868 cc (WJZ(DW8))	04.1998-	132088	25
FIAT	SCUDO Kasten (220L) / 1.9 D	51 kW 2383 cc	02.1996-	132083	29
FIAT	SCUDO Kasten (220L) / 1.9 TD	66 kW 1905 cc (DHX(XUD9TF/L))	02.1996-	132081	28
FIAT	SCUDO Kasten (220L) / 2.0 JTD	69 kW 1997 cc (RHX)	12.1999-	132088	25
FIAT	SCUDO Kasten (220L) / 2.0 JTD	80 kW 1997 cc (RHZ)	12.2002-	132088	25
FIAT	SCUDO Kasten (220L) / 2.0 JTD 16V	80 kW 1997 cc (RHW(DW10ATED4))	05.1999-12.2006	132088	25
FIAT	SCUDO Kasten (270_) / 2.0 D Multijet	100 kW 1997 cc (RHR)	01.2007-	132088	25
FIAT	SCUDO Kasten (270_) / 2.0 D Multijet	88 kW 1997 cc (RHK)	01.2007-	132088	25
FIAT	SCUDO Pritsche (270_) / 2.0 D Multij.	100 kW 1997 cc (RHR)	01.2007-	132088	25
FIAT	SCUDO Pritsche (270_) / 2.0 D Multij.	88 kW 1997 cc (RHK)	01.2007-	132088	25
FIAT	SIENA (178_) / 1.7 D	52 kW 1697 cc	03.2002-	132082	29
FIAT	SIENA (178_) / 1.7 TD	51 kW 1697 cc	02.2006-	132082	29
FIAT	SPAZIO / 1.3 D	33 kW 1301 cc	07.1982-07.1983	132053	27
FIAT	STRADA (178E) / 1.7 TD	51 kW 1998 cc	06.1999-	132082	29
FIAT	STRADA (178E) / 1.9 D	46 kW 2188 cc	12.2000-	132082	29
FIAT	STRADA (178E) / 1.9 JTD	59 kW 1997 cc	04.2003-	132082	29
FIAT	TEMPRA (159) / 1.9 D (159.AG)	48 kW 1929 cc (149A1.000)	07.1991-08.1996	132053	27
FIAT	TEMPRA (159) / 1.9 TD	66 kW 1929 cc	05.1990-08.1996	132082	29
FIAT	TEMPRA (159) / 1.9 TD	66 kW 1929 cc (160A6.000)	05.1990-08.1996	132053	27
FIAT	TEMPRA S.W. (159) / 1.9 D (159.AG)	48 kW 1929 cc (149A1.000)	07.1991-08.1996	132053	27
FIAT	TEMPRA S.W. (159) / 1.9 TD	66 kW 1929 cc	07.1991-02.1995	132082	29
FIAT	TEMPRA S.W. (159) / 1.9 TD	66 kW 1929 cc (160A6.000)	07.1991-02.1995	132053	27
FIAT	TEMPRA SW (159) / 1.9 D (159.AG)	48 kW 1929 cc	07.1991-08.1996	132053	27
FIAT	TEMPRA SW (159) / 1.9 TD	66 kW 1929 cc	07.1991-02.1995	132053	27
FIAT	TEMPRA SW (159) / 1.9 TD	66 kW 1929 cc	07.1991-02.1995	132082	29
FIAT	TIPO (160) / 1.7 D (160.AG)	43 kW 1697 cc	01.1988-10.1994	132084	29
FIAT	TIPO (160) / 1.7 D (160.AG)	43 kW 1697 cc (149B4.000)	01.1988-10.1994	132053	27
FIAT	TIPO (160) / 1.7 D (160.AG)	45 kW 1929 cc	01.1988-10.1995	132084	29
FIAT	TIPO (160) / 1.9 D	48 kW 1929 cc (149A1.000)	07.1991-08.1996	132053	27
FIAT	TIPO (160) / 1.9 TD	66 kW 1929 cc (160A6.000)	09.1990-04.1995	132053	27
FIAT	ULYSSE (179AX) / 2.0 D Multijet	100 kW 1997 cc (RHR)	05.2006-	132088	25
FIAT	ULYSSE (179AX) / 2.0 D Multijet	88 kW 1997 cc (RHK)	05.2006-	132088	25
FIAT	ULYSSE (179AX) / 2.0 JTD	80 kW 1997 cc (RHW(DW10ATED4))	08.2002-	132088	25
FIAT	ULYSSE (179AX) / 2.2 JTD	94 kW 2179 cc (16790)	08.2002-	132088	25
FIAT	ULYSSE (220) / 1.9 TD (220AH5)	66 kW 1905 cc (DHX(XUD9TF/L))	02.1995-08.2002	132081	28
FIAT	ULYSSE (220) / 2.0 JTD	80 kW 1997 cc (RHZ)	10.1999-08.2002	132088	25
FIAT	ULYSSE (220) / 2.0 JTD 16V	80 kW 1997 cc (RHW(DW10ATED4))	05.1999-08.2002	132088	25
FIAT	UNO (146A/E) / 1.3 Super D	33 kW 1302 cc (127A5.000)	06.1983-03.1992	132053	27



Modell
Model

Motor
Engine



Baujahr
Construction year

HÜCO-NO. Seite
Page

	Modell Model	Motor Engine	Baujahr Construction year	HÜCO-NO.	Seite Page
FIAT	UNO (146A/E) / 1.3 Turbo i.e.	73 kW 2445 cc	01.1987-12.1987	132040	18
FIAT	UNO (146A/E) / 1.3 Turbo i.e.	74 kW 1968 cc	09.1989-03.1991	132040	18
FIAT	UNO (146A/E) / 1.3 Turbo i.e.	77 kW 1301 cc	04.1985-08.1989	132040	18
FIAT	UNO (146A/E) / 1.4 Turbo i.e.	82 kW 1968 cc	09.1989-09.1993	132040	18
FIAT	UNO (146A/E) / 1.7 D	43 kW 1697 cc (146B2.000)	11.1994-08.2000	132053	27
FIAT	UNO (146A/E) / 60 D	42 kW 1698 cc (146B2.000)	09.1989-12.1993	132053	27
FIAT	UNO (146A/E) / 60 D 1.7	42 kW 1698 cc	09.1989-12.1993	132053	27
FIAT	UNO (146A/E) / 60 D 1.7	44 kW 1698 cc (149B3.000)	07.1986-08.1989	132053	27
FORD	CAPRI III (GECF) / 2.8 Super Injection	118 kW 1998 cc	01.1981-04.1987	132000	15
FORD	CAPRI Mk III (GECF) / 2.8 Super Inj	118 kW 2792 cc	01.1981-04.1987	132000	15
FORD	COURIER Kasten (F3L, F5L) / 1.8 D	44 kW 1588 cc	09.1991-02.1996	132090	24
FORD	COURIER Kasten (J5_, J3_) / 1.8 D	44 kW 2155 cc	02.1996-	132065	22
FORD	COURIER Kasten (JV_) / D 1.8	44 kW 1753 cc	05.1998-	132065	22
FORD	ESCORT ,81 Courier (AVA) / 1.6 D	40 kW 1608 cc	02.1984-02.1986	132067	22
FORD	ESCORT ,81 Courier (AVA) / 1.6 D	40 kW 1753 cc	02.1984-02.1986	132065	22
FORD	ESCORT ,81 Express (AVA) / 1.6 D	40 kW 1608 cc	02.1984-02.1986	132065	22
FORD	ESCORT ,81 Express (AVA) / 1.6 D	40 kW 1608 cc	02.1984-02.1986	132067	22
FORD	ESCORT ,86 Courier (AVF) / 1.6 D	40 kW 1608 cc	02.1986-07.1990	132067	22
FORD	ESCORT ,86 Courier (AVF) / 1.6 D	40 kW 1753 cc	02.1986-07.1990	132065	22
FORD	ESCORT ,86 Courier (AVF) / 1.8 D	44 kW 2500 cc	07.1988-07.1990	132067	22
FORD	ESCORT ,86 Express (AVF) / 1.6 D	40 kW 1608 cc	02.1986-07.1990	132065	22
FORD	ESCORT ,86 Express (AVF) / 1.6 D	40 kW 1608 cc	02.1986-07.1990	132067	22
FORD	ESCORT ,86 Express (AVF) / 1.8 D	44 kW 1753 cc	07.1988-07.1990	132067	22
FORD	ESCORT ,91 Courier (AVL) / 1.8 D	44 kW 1753 cc	07.1990-12.1994	132090	24
FORD	ESCORT ,91 Courier (AVL) / 1.8 D	44 kW 1796 cc	07.1990-12.1994	132067	22
FORD	ESCORT ,91 Express (AVL) / 1.8 D	44 kW 1753 cc	07.1990-12.1994	132067	22
FORD	ESCORT ,91 Express (AVL) / 1.8 D	44 kW 1753 cc	07.1990-12.1994	132090	24
FORD	ESCORT ,95 Express (AVL) / 1.8 D	44 kW 1753 cc	01.1995-	132067	22
FORD	ESCORT ,95 Express (AVL) / 1.8 D	44 kW 1753 cc	01.1995-	132090	24
FORD	ESCORT CLASSIC (AAL, ABL) / 1.8 TD	66 kW 2188 cc	10.1998-07.2000	132067	22
FORD	ESCORT CLASSIC Turnier (ANL) / 1.8 TD	66 kW 1753 cc	02.1999-07.2000	132067	22
FORD	ESCORT III (GAA) / 1.6 D	40 kW 1422 cc	02.1984-12.1985	132065	22
FORD	ESCORT III (GAA) / 1.6 D	40 kW 1608 cc	02.1984-12.1985	132067	22
FORD	ESCORT III Break (AWA) / 1.6 D	40 kW 2410 cc	02.1984-12.1985	132065	22
FORD	ESCORT III Kombi (AWA) / 1.6 D	40 kW 1608 cc	02.1984-12.1985	132065	22
FORD	ESCORT IV (GAF, AWF, ABFT) / 1.6 D	40 kW 1608 cc	01.1986-01.1989	132067	22
FORD	ESCORT IV (GAF, AWF, ABFT) / 1.6 D	40 kW 2500 cc	01.1986-01.1989	132065	22
FORD	ESCORT IV (GAF, AWF, ABFT) / 1.8 D	44 kW 2288 cc	01.1989-07.1990	132067	22
FORD	ESCORT IV Break (AWF, AVF) / 1.6 D	40 kW 1608 cc	01.1986-01.1989	132067	22
FORD	ESCORT IV Break (AWF, AVF) / 1.6 D	40 kW 2148 cc	01.1986-01.1989	132065	22
FORD	ESCORT IV Break (AWF, AVF) / 1.8 D	44 kW 1608 cc	01.1989-07.1990	132067	22
FORD	ESCORT IV Kombi (AWF, AVF) / 1.6 D	40 kW 1608 cc	01.1986-01.1989	132065	22
FORD	ESCORT IV Kombi (AWF, AVF) / 1.6 D	40 kW 1608 cc	01.1986-01.1989	132067	22
FORD	ESCORT IV Kombi (AWF, AVF) / 1.8 D	44 kW 1753 cc	01.1989-07.1990	132067	22
FORD	ESCORT Mk III (GAA) / 1.6 D	40 kW 1608 cc	02.1984-12.1985	132065	22
FORD	ESCORT Mk III (GAA) / 1.6 D	40 kW 1608 cc	02.1984-12.1985	132067	22
FORD	ESCORT Mk III Kombi (AWA) / 1.6 D	40 kW 1608 cc	02.1984-12.1985	132065	22
FORD	ESCORT Mk IV (GAF, AWF, ABFT) / 1.6 D	40 kW 1608 cc	01.1986-01.1989	132065	22
FORD	ESCORT Mk IV (GAF, AWF, ABFT) / 1.6 D	40 kW 1608 cc	01.1986-01.1989	132067	22
FORD	ESCORT Mk IV (GAF, AWF, ABFT) / 1.8 D	44 kW 1753 cc	01.1989-07.1990	132067	22
FORD	ESCORT Mk IV Kombi (AWF, AVF) / 1.6 D	40 kW 1608 cc	01.1986-01.1989	132065	22
FORD	ESCORT Mk IV Kombi (AWF, AVF) / 1.6 D	40 kW 1608 cc	01.1986-01.1989	132067	22
FORD	ESCORT Mk IV Kombi (AWF, AVF) / 1.8 D	44 kW 1753 cc	01.1989-07.1990	132067	22
FORD	ESCORT Mk V (GAL) / 1.8 D	44 kW 1968 cc	07.1990-12.1992	132067	22
FORD	ESCORT Mk V Kombi (GAL, AVL) / 1.8 D	44 kW 2933 cc	07.1990-12.1992	132067	22
FORD	ESCORT Mk VI (GAL) / 1.8 D	44 kW 1753 cc	09.1992-01.1995	132090	24
FORD	ESCORT Mk VI (GAL) / 1.8 D	44 kW 1986 cc	09.1992-01.1995	132067	22
FORD	ESCORT Mk VI (GAL) / 1.8 TD	66 kW 1753 cc	02.1993-01.1995	132067	22
FORD	ESCORT Mk VI (GAL) / 1.8 TD	66 kW 1753 cc	02.1993-01.1995	132090	24
FORD	ESCORT Mk VI Kombi (GAL) / 1.8 D	44 kW 1753 cc	09.1992-01.1995	132090	24
FORD	ESCORT Mk VI Kombi (GAL) / 1.8 D	44 kW 2198 cc	09.1992-01.1995	132067	22
FORD	ESCORT Mk VI Kombi (GAL) / 1.8 TD	66 kW 1968 cc	02.1993-01.1995	132067	22
FORD	ESCORT Mk VI Stufenh. (GAL) / 1.8 D	44 kW 1753 cc	08.1993-01.1995	132067	22
FORD	ESCORT Mk VI Stufenh. (GAL) / 1.8 D	44 kW 1753 cc	08.1993-01.1995	132090	24
FORD	ESCORT Mk VI Stufenh. (GAL) / 1.8 TD	66 kW 1753 cc	08.1993-01.1995	132090	24
FORD	ESCORT Mk VI Stufenh. (GAL) / 1.8 TD	66 kW 2260 cc	08.1993-01.1995	132067	22
FORD	ESCORT Mk VII / 1.8 D	44 kW 1753 cc	01.1995-12.1996	132067	22



Modell
Model

Motor
Engine



Baujahr
Construction year

HÜCO-NO. Seite
Page

FORD	ESCORT Mk VII / 1.8 D	44 kW 1753 cc	01.1995-12.1996	132090	24
FORD	ESCORT Mk VII / 1.8 TD	66 kW 1588 cc	01.1995-10.1998	132067	22
FORD	ESCORT Mk VII / 1.8 TD	66 kW 1753 cc	01.1995-10.1998	132090	24
FORD	ESCORT Mk VII (GAL, AAL, ABL) / 1.8 D	44 kW 1753 cc	01.1995-12.1996	132090	24
FORD	ESCORT Mk VII (GAL, AAL, ABL) / 1.8 D	44 kW 1986 cc	01.1995-12.1996	132067	22
FORD	ESCORT Mk VII (GAL, AAL, ABL) / 1.8 TD	66 kW 1753 cc	01.1995-10.1998	132090	24
FORD	ESCORT Mk VII (GAL, AAL, ABL) / 1.8 TD	66 kW 1905 cc	01.1995-10.1998	132067	22
FORD	ESCORT Mk VII Cabriolet (ALL) / 1.8 TD	66 kW 1753 cc	09.1995-08.1998	132090	24
FORD	ESCORT Mk VII Cabriolet (ALL) / 1.8 TD	66 kW 1995 cc	09.1995-08.1998	132067	22
FORD	ESCORT Mk VII Kombi (GAL, ANL) / 1.8 D	44 kW 1753 cc	01.1995-02.1999	132090	24
FORD	ESCORT Mk VII Kombi (GAL, ANL) / 1.8 D	44 kW 2792 cc	01.1995-02.1999	132067	22
FORD	ESCORT Mk VII Kombi (GAL, ANL) / 1.8 TD	66 kW 1753 cc	01.1995-02.1999	132067	22
FORD	ESCORT Mk VII Kombi (GAL, ANL) / 1.8 TD	66 kW 1753 cc	01.1995-02.1999	132090	24
FORD	ESCORT V (GAL) / 1.8 D	44 kW 1753 cc	07.1990-12.1992	132067	22
FORD	ESCORT V Break (GAL, AVL) / 1.8 D	44 kW 1753 cc	07.1990-12.1992	132067	22
FORD	ESCORT V Kombi (GAL, AVL) / 1.8 D	44 kW 1753 cc	07.1990-12.1992	132067	22
FORD	ESCORT VI (GAL) / 1.8 D	44 kW 1753 cc	09.1992-01.1995	132067	22
FORD	ESCORT VI (GAL) / 1.8 D	44 kW 1753 cc	09.1992-01.1995	132090	24
FORD	ESCORT VI (GAL) / 1.8 TD	66 kW 1753 cc	02.1993-01.1995	132067	22
FORD	ESCORT VI (GAL) / 1.8 TD	66 kW 1753 cc	02.1993-01.1995	132090	24
FORD	ESCORT VI Break (GAL) / 1.8 D	44 kW 1753 cc	09.1992-01.1995	132067	22
FORD	ESCORT VI Break (GAL) / 1.8 D	44 kW 1753 cc	09.1992-01.1995	132090	24
FORD	ESCORT VI Break (GAL) / 1.8 TD	66 kW 1753 cc	02.1993-01.1995	132067	22
FORD	ESCORT VI Kombi (GAL) / 1.8 D	44 kW 1753 cc	09.1992-01.1995	132067	22
FORD	ESCORT VI Kombi (GAL) / 1.8 D	44 kW 1753 cc	09.1992-01.1995	132090	24
FORD	ESCORT VI Kombi (GAL) / 1.8 TD	66 kW 1753 cc	02.1993-01.1995	132067	22
FORD	ESCORT VI Stufenh. (GAL) / 1.8 D	44 kW 1753 cc	08.1993-01.1995	132067	22
FORD	ESCORT VI Stufenh. (GAL) / 1.8 D	44 kW 1753 cc	08.1993-01.1995	132090	24
FORD	ESCORT VI Stufenh. (GAL) / 1.8 TD	66 kW 1753 cc	08.1993-01.1995	132067	22
FORD	ESCORT VI Stufenh. (GAL) / 1.8 TD	66 kW 1753 cc	08.1993-01.1995	132090	24
FORD	ESCORT VII (GAL, AAL, ABL) / 1.8 D	44 kW 1753 cc	01.1995-12.1996	132067	22
FORD	ESCORT VII (GAL, AAL, ABL) / 1.8 D	44 kW 1753 cc	01.1995-12.1996	132090	24
FORD	ESCORT VII (GAL, AAL, ABL) / 1.8 TD	66 kW 1753 cc	01.1995-10.1998	132067	22
FORD	ESCORT VII (GAL, AAL, ABL) / 1.8 TD	66 kW 1753 cc	01.1995-10.1998	132090	24
FORD	ESCORT VII Cabriolet (ALL) / 1.8 TD	66 kW 1753 cc	09.1995-08.1998	132067	22
FORD	ESCORT VII Cabriolet (ALL) / 1.8 TD	66 kW 1753 cc	09.1995-08.1998	132090	24
FORD	ESCORT VII Clipper (GAL, ANL) / 1.8 D	44 kW 1753 cc	01.1995-02.1999	132067	22
FORD	ESCORT VII Clipper (GAL, ANL) / 1.8 D	44 kW 1753 cc	01.1995-02.1999	132090	24
FORD	ESCORT VII Clipper (GAL, ANL) / 1.8 TD	66 kW 1753 cc	01.1995-02.1999	132067	22
FORD	ESCORT VII Clipper (GAL, ANL) / 1.8 TD	66 kW 1753 cc	01.1995-02.1999	132090	24
FORD	ESCORT VII Kombi (GAL, ANL) / 1.8 D	44 kW 1753 cc	01.1995-02.1999	132067	22
FORD	ESCORT VII Kombi (GAL, ANL) / 1.8 D	44 kW 1753 cc	01.1995-02.1999	132090	24
FORD	ESCORT VII Kombi (GAL, ANL) / 1.8 TD	66 kW 1753 cc	01.1995-02.1999	132067	22
FORD	ESCORT VII Kombi (GAL, ANL) / 1.8 TD	66 kW 1753 cc	01.1995-02.1999	132090	24
FORD	ESCORT VII Stufenh. / 1.8 TD	66 kW 1753 cc	01.1995-10.1998	132067	22
FORD	ESCORT VII Stufenh. / 1.8 TD	66 kW 1753 cc	01.1995-10.1998	132090	24
FORD	ESCORT VII Stufenh. (GAL, AFL) / 1.8 D	44 kW 1753 cc	01.1995-12.1996	132067	22
FORD	ESCORT VII Stufenh. (GAL, AFL) / 1.8 D	44 kW 1753 cc	01.1995-12.1996	132090	24
FORD	FIESTA II (FBD) / 1.6 D (FBD)	40 kW 1608 cc	04.1984-02.1989	132067	22
FORD	FIESTA II (FBD) / 1.6 D (FBD)	40 kW 1905 cc	04.1984-02.1989	132065	22
FORD	FIESTA III (GFJ) / 1.8 D	44 kW 1700 cc	03.1989-12.1995	132067	22
FORD	FIESTA III (GFJ) / 1.8 D	44 kW 1753 cc	03.1989-12.1995	132090	24
FORD	FIESTA IV (JA_, JB_) / 1.8 D	44 kW 1753 cc	08.1995-04.2000	132065	22
FORD	FIESTA Kasten (F3L, F5L) / 1.8 D	44 kW 1753 cc	09.1991-02.1996	132090	24
FORD	FIESTA Kasten (FVD) / 1.8 D (FVJ)	43 kW 1896 cc	03.1989-12.1995	132090	24
FORD	FIESTA Kasten (J5_, J3_) / 1.8 D	44 kW 1753 cc	02.1996-	132065	22
FORD	FIESTA Kasten (JV_) / D 1.8	44 kW 1753 cc	05.1998-	132065	22
FORD	FIESTA Mk II (FBD) / 1.6 D (FBD)	40 kW 1608 cc	04.1984-02.1989	132065	22
FORD	FIESTA Mk II (FBD) / 1.6 D (FBD)	40 kW 1608 cc	04.1984-02.1989	132067	22
FORD	FIESTA Mk III (GFJ) / 1.8 D	44 kW 1753 cc	03.1989-12.1995	132067	22
FORD	FIESTA Mk III (GFJ) / 1.8 D	44 kW 1753 cc	03.1989-12.1995	132090	24
FORD	FIESTA Mk IV (JA_, JB_) / 1.8 D	44 kW 1753 cc	08.1995-04.2000	132065	22
FORD	FOCUS III / 1.6 EcoBoost	134 kW 1796 cc	04.2011-	132045	23
FORD	GRANADA (GU) / 2.8 i	108 kW 2461 cc	08.1977-08.1985	132000	15
FORD	GRANADA (GU) / 2.8 i	110 kW 1698 cc	10.1982-08.1985	132000	15
FORD	GRANADA (GU) / 2.8 i	118 kW 2792 cc	08.1977-08.1981	132000	15
FORD	GRANADA Break (GNU) / 2.8 i	108 kW 2188 cc	08.1977-08.1985	132000	15



Modell
Model

Motor
Engine



Baujahr
Construction year

HÜCO-NO. Seite
Page

FORD	GRANADA Break (GNU) / 2.8 i	110 kW 2792 cc	10.1982-08.1985	132000	15
FORD	GRANADA Break (GNU) / 2.8 i	118 kW 2792 cc	08.1977-08.1981	132000	15
FORD	GRANADA Kombi (GNU) / 2.8 i	108 kW 2792 cc	08.1977-08.1985	132000	15
FORD	GRANADA Kombi (GNU) / 2.8 i	110 kW 2792 cc	10.1982-08.1985	132000	15
FORD	GRANADA Kombi (GNU) / 2.8 i	118 kW 2792 cc	08.1977-08.1981	132000	15
FORD	GRANADA Mk III (GAE, GGE) / 1.8	66 kW 1905 cc	04.1985-02.1992	132000	15
FORD	GRANADA Mk III (GAE, GGE) / 2.0	77 kW 2799 cc	04.1985-08.1989	132000	15
FORD	GRANADA Mk III (GAE, GGE) / 2.0 i	74 kW 1796 cc	10.1985-12.1990	132000	15
FORD	GRANADA Mk III (GAE, GGE) / 2.0 i	85 kW 1993 cc	04.1985-02.1992	132000	15
FORD	GRANADA Mk III (GAE, GGE) / 2.0 i	85 kW 2299 cc	02.1992-09.1994	132000	15
FORD	GRANADA Mk III (GAE, GGE) / 2.0 i	88 kW 2399 cc	05.1989-09.1994	132000	15
FORD	GRANADA Mk III (GAE, GGE) / 2.4 i	92 kW 1993 cc	10.1988-02.1992	132000	15
FORD	GRANADA Mk III (GAE, GGE) / 2.4 i	92 kW 2394 cc	10.1988-02.1992	132160	37
FORD	GRANADA Mk III (GAE, GGE) / 2.4 i	96 kW 2151 cc	09.1986-09.1988	132000	15
FORD	GRANADA Mk III (GAE, GGE) / 2.4 i KAT	92 kW 1968 cc	10.1988-09.1994	132000	15
FORD	GRANADA Mk III (GAE, GGE) / 2.5 D	51 kW 1870 cc	12.1985-02.1992	132060	22
FORD	GRANADA Mk III (GAE, GGE) / 2.8 i	110 kW 1769 cc	04.1985-11.1986	132000	15
FORD	GRANADA Mk III (GAE, GGE) / 2.8 i 4x4	110 kW 2394 cc	10.1985-11.1986	132000	15
FORD	GRANADA Mk III (GAE, GGE) / 2.9 i	107 kW 1905 cc	09.1986-09.1994	132000	15
FORD	GRANADA Mk III (GAE, GGE) / 2.9 i	110 kW 2874 cc	09.1986-09.1994	132000	15
FORD	GRANADA Mk III (GAE, GGE) / 2.9 i 24V	143 kW 1905 cc	04.1991-09.1994	132000	15
FORD	GRANADA Mk III (GAE, GGE) / 2.9 i 4x4	107 kW 2936 cc	05.1988-02.1993	132000	15
FORD	GRANADA Mk III (GAE, GGE) / 2.9 i 4x4	110 kW 2933 cc	09.1986-09.1994	132000	15
FORD	GRANADA Mk III Kombi (GGE) / 2.0 i	85 kW 1870 cc	09.1991-09.1994	132000	15
FORD	GRANADA Mk III Kombi (GGE) / 2.0 i	88 kW 1997 cc	09.1991-09.1994	132000	15
FORD	GRANADA Mk III Kombi (GGE) / 2.4 i	92 kW 1870 cc	09.1991-09.1994	132000	15
FORD	GRANADA Mk III Kombi (GGE) / 2.9 24V	143 kW 1799 cc	08.1993-09.1994	132000	15
FORD	GRANADA Mk III Kombi (GGE) / 2.9 i	107 kW 2188 cc	09.1991-09.1994	132000	15
FORD	GRANADA Mk III Kombi (GGE) / 2.9 i 4x4	107 kW 2936 cc	05.1988-02.1993	132000	15
FORD	GRANADA Mk III Stufenh. 2.9 i 24V	143 kW 2298 cc	04.1991-09.1994	132000	15
FORD	GRANADA Mk III Stufenh. 2.9 i 4x4	107 kW 1598 cc	12.1989-10.1994	132000	15
FORD	GRANADA Mk III Stufenh. (GGE) / 2.0 i	85 kW 2874 cc	02.1992-09.1994	132000	15
FORD	GRANADA Mk III Stufenh. (GGE) / 2.0 i	88 kW 2933 cc	05.1989-09.1994	132000	15
FORD	GRANADA Mk III Stufenh. (GGE) / 2.0 i	92 kW 1796 cc	05.1989-02.1992	132000	15
FORD	GRANADA Mk III Stufenh. (GGE) / 2.4 i	92 kW 1598 cc	10.1988-10.1994	132000	15
FORD	GRANADA Mk III Stufenh. (GGE) / 2.9 i	107 kW 1608 cc	09.1986-12.1994	132000	15
FORD	MONDEO (GBP) / 1.8 TD	65 kW 1979 cc	06.1993-08.1996	132090	24
FORD	MONDEO I (GBP) / 1.8 TD	65 kW 1753 cc	06.1993-08.1996	132090	24
FORD	MONDEO I Clipper (BNP) / 1.8 TD	65 kW 2499 cc	06.1993-08.1996	132090	24
FORD	MONDEO I Kombi (BNP) / 1.8 TD	65 kW 1753 cc	06.1993-08.1996	132090	24
FORD	MONDEO I Stufenh. (GBP) / 1.8 TD	65 kW 1905 cc	06.1993-08.1996	132090	24
FORD	MONDEO I Stufenh. (GBP) / 1.8 TD	66 kW 2299 cc	10.1995-08.1996	132090	24
FORD	MONDEO Kombi (BNP) / 1.8 TD	65 kW 1753 cc	06.1993-08.1996	132090	24
FORD	MONDEO Stufenh. (GBP) / 1.8 TD	65 kW 1753 cc	06.1993-08.1996	132090	24
FORD	MONDEO Stufenh. (GBP) / 1.8 TD	66 kW 1753 cc	10.1995-08.1996	132090	24
FORD	ORION (AFD) / 1.6 D	40 kW 1608 cc	02.1984-03.1986	132067	22
FORD	ORION (AFD) / 1.6 D	40 kW 2446 cc	02.1984-03.1986	132065	22
FORD	ORION I (AFD) / 1.6 D	40 kW 1608 cc	02.1984-03.1986	132065	22
FORD	ORION I (AFD) / 1.6 D	40 kW 1608 cc	02.1984-03.1986	132067	22
FORD	ORION II (AFF) / 1.6 D	40 kW 1608 cc	12.1985-01.1989	132067	22
FORD	ORION II (AFF) / 1.6 D	40 kW 1998 cc	12.1985-01.1989	132065	22
FORD	ORION II (AFF) / 1.8 D	44 kW 1608 cc	01.1989-07.1990	132067	22
FORD	ORION III (GAL) / 1.8 D	44 kW 1753 cc	11.1990-12.1993	132090	24
FORD	ORION III (GAL) / 1.8 D	44 kW 2138 cc	11.1990-12.1993	132067	22
FORD	ORION III (GAL) / 1.8 TD	66 kW 1588 cc	03.1992-12.1993	132067	22
FORD	ORION III (GAL) / 1.8 TD	66 kW 1753 cc	03.1992-12.1993	132090	24
FORD	ORION Mk II (AFF) / 1.6 D	40 kW 1608 cc	12.1985-01.1989	132065	22
FORD	ORION Mk II (AFF) / 1.6 D	40 kW 1608 cc	12.1985-01.1989	132067	22
FORD	ORION Mk II (AFF) / 1.8 D	44 kW 1753 cc	01.1989-07.1990	132067	22
FORD	ORION Mk III (GAL) / 1.8 D	44 kW 1753 cc	11.1990-12.1993	132067	22
FORD	ORION Mk III (GAL) / 1.8 D	44 kW 1753 cc	11.1990-12.1993	132090	24
FORD	ORION Mk III (GAL) / 1.8 TD	66 kW 1753 cc	03.1992-12.1993	132067	22
FORD	ORION Mk III (GAL) / 1.8 TD	66 kW 1753 cc	03.1992-12.1993	132090	24
FORD	SCORPIO I (GAE, GGE) / 1.8	66 kW 1796 cc	04.1985-02.1992	132000	15
FORD	SCORPIO I (GAE, GGE) / 2.0	77 kW 1993 cc	04.1985-08.1989	132000	15
FORD	SCORPIO I (GAE, GGE) / 2.0 i	74 kW 1993 cc	10.1985-12.1990	132000	15
FORD	SCORPIO I (GAE, GGE) / 2.0 i	85 kW 1993 cc	02.1992-09.1994	132000	15



Modell
Model

Motor
Engine



Baujahr
Construction year

HÜCO-NO. Seite
Page

FORD	SCORPIO I (GAE, GGE) / 2.0 i	85 kW 1993 cc	04.1985-02.1992	132000	15
FORD	SCORPIO I (GAE, GGE) / 2.0 i	88 kW 1998 cc	05.1989-09.1994	132000	15
FORD	SCORPIO I (GAE, GGE) / 2.4 i	92 kW 2394 cc	10.1988-02.1992	132000	15
FORD	SCORPIO I (GAE, GGE) / 2.4 i	92 kW 2394 cc	10.1988-02.1992	132160	37
FORD	SCORPIO I (GAE, GGE) / 2.4 i	96 kW 2394 cc	09.1986-09.1988	132000	15
FORD	SCORPIO I (GAE, GGE) / 2.4 i KAT	92 kW 2394 cc	10.1988-09.1994	132000	15
FORD	SCORPIO I (GAE, GGE) / 2.5 D	51 kW 2498 cc	12.1985-02.1992	132060	22
FORD	SCORPIO I (GAE, GGE) / 2.8 i	110 kW 2792 cc	04.1985-11.1986	132000	15
FORD	SCORPIO I (GAE, GGE) / 2.8 i 4x4	110 kW 2792 cc	10.1985-11.1986	132000	15
FORD	SCORPIO I (GAE, GGE) / 2.9 i	107 kW 2933 cc	09.1986-09.1994	132000	15
FORD	SCORPIO I (GAE, GGE) / 2.9 i	110 kW 2933 cc	09.1986-09.1994	132000	15
FORD	SCORPIO I (GAE, GGE) / 2.9 i 24V	143 kW 2933 cc	04.1991-09.1994	132000	15
FORD	SCORPIO I (GAE, GGE) / 2.9 i 4x4	107 kW 2933 cc	05.1988-02.1993	132000	15
FORD	SCORPIO I (GAE, GGE) / 2.9 i 4x4	110 kW 2933 cc	09.1986-09.1994	132000	15
FORD	SCORPIO I Break (GGE) / 2.0 i	85 kW 1998 cc	09.1991-09.1994	132000	15
FORD	SCORPIO I Break (GGE) / 2.0 i	88 kW 1998 cc	09.1991-09.1994	132000	15
FORD	SCORPIO I Break (GGE) / 2.4 i	92 kW 2394 cc	09.1991-09.1994	132000	15
FORD	SCORPIO I Break (GGE) / 2.9 24V	143 kW 2933 cc	08.1993-09.1994	132000	15
FORD	SCORPIO I Break (GGE) / 2.9 i	107 kW 2933 cc	09.1991-09.1994	132000	15
FORD	SCORPIO I Break (GGE) / 2.9 i 4x4	107 kW 2933 cc	05.1988-02.1993	132000	15
FORD	SCORPIO I Kombi (GGE) / 2.0 i	85 kW 1998 cc	09.1991-09.1994	132000	15
FORD	SCORPIO I Kombi (GGE) / 2.0 i	88 kW 1998 cc	09.1991-09.1994	132000	15
FORD	SCORPIO I Kombi (GGE) / 2.4 i	92 kW 2394 cc	09.1991-09.1994	132000	15
FORD	SCORPIO I Kombi (GGE) / 2.9 24V	143 kW 2933 cc	08.1993-09.1994	132000	15
FORD	SCORPIO I Kombi (GGE) / 2.9 i	107 kW 2933 cc	09.1991-09.1994	132000	15
FORD	SCORPIO I Kombi (GGE) / 2.9 i 4x4	107 kW 2933 cc	05.1988-02.1993	132000	15
FORD	SCORPIO I Stufenh. (GGE) / 2.0 i	85 kW 1998 cc	02.1992-09.1994	132000	15
FORD	SCORPIO I Stufenh. (GGE) / 2.0 i	88 kW 1998 cc	05.1989-09.1994	132000	15
FORD	SCORPIO I Stufenh. (GGE) / 2.0 i	92 kW 1998 cc	05.1989-02.1992	132000	15
FORD	SCORPIO I Stufenh. (GGE) / 2.4 i	92 kW 2394 cc	10.1988-10.1994	132000	15
FORD	SCORPIO I Stufenh. (GGE) / 2.9 i	107 kW 2933 cc	09.1986-12.1994	132000	15
FORD	SCORPIO I Stufenh. (GGE) / 2.9 i 24V	143 kW 2933 cc	04.1991-09.1994	132000	15
FORD	SCORPIO I Stufenh. (GGE) / 2.9 i 4x4	107 kW 2933 cc	12.1989-10.1994	132000	15
FORD	SIERRA (GBC, GB4) / 2.0 4x4	88 kW 1993 cc	01.1990-02.1993	132000	15
FORD	SIERRA (GBC, GB4) / 2.0 i	74 kW 2299 cc	01.1987-12.1989	132000	15
FORD	SIERRA (GBC, GB4) / 2.0 i	85 kW 1993 cc	01.1987-02.1993	132000	15
FORD	SIERRA (GBC, GB4) / 2.0 i	88 kW 1998 cc	01.1990-02.1993	132000	15
FORD	SIERRA (GBC, GB4) / 2.0 i KAT	74 kW 2500 cc	01.1987-02.1993	132000	15
FORD	SIERRA (GBC, GB4) / 2.9 i	107 kW 2936 cc	08.1988-02.1993	132000	15
FORD	SIERRA Break (BNC) / 2.8 XR4i	105 kW 2792 cc	08.1982-12.1986	132000	15
FORD	SIERRA Kombi (BNC) / 2.8 XR4i	105 kW 2792 cc	08.1982-12.1986	132000	15
FORD	SIERRA Kombi (BNG) / 2.0 4x4	88 kW 1896 cc	02.1990-02.1993	132000	15
FORD	SIERRA Kombi (BNG) / 2.0 i	74 kW 1993 cc	01.1987-02.1993	132000	15
FORD	SIERRA Kombi (BNG) / 2.0 i	85 kW 1993 cc	01.1987-02.1993	132000	15
FORD	SIERRA Kombi (BNG) / 2.0 i	88 kW 1896 cc	05.1989-02.1993	132000	15
FORD	SIERRA Kombi (BNG) / 2.0 i KAT	74 kW 1753 cc	01.1987-02.1993	132000	15
FORD	SIERRA Kombi (BNG) / 2.8 4x4	110 kW 2376 cc	01.1987-08.1988	132000	15
FORD	SIERRA Kombi (BNG) / 2.9	107 kW 2792 cc	08.1988-02.1993	132000	15
FORD	SIERRA Kombi (BNG) / 2.9 4x4	107 kW 2792 cc	08.1988-02.1993	132000	15
FORD	SIERRA Schrägh. 2.0 16V Cosworth 4x4	162 kW 1993 cc	01.1990-02.1993	132000	15
FORD	SIERRA Schrägh. 2.8 i XR 4x4	110 kW 2383 cc	01.1987-08.1988	132000	15
FORD	SIERRA Schrägh. 2.9 i XR 4x4	107 kW 2936 cc	08.1988-02.1993	132000	15
FORD	SIERRA Schrägh. 2.9 i XR 4x4	110 kW 2933 cc	08.1988-02.1993	132000	15
FORD	SIERRA Schrägh. (GBC) / 2.0 i	85 kW 1975 cc	03.1985-12.1986	132000	15
FORD	SIERRA Schrägh. (GBC) / 2.8 XR 4x4	110 kW 2792 cc	02.1985-12.1986	132000	15
FORD	SIERRA Schrägh. (GBC) / 2.8 XR4i	105 kW 2998 cc	08.1982-12.1986	132000	15
FORD	SIERRA Schrägh. (GBC) / 2.8 XR4i	110 kW 1993 cc	08.1982-12.1986	132000	15
FORD	SIERRA Schrägh. (GBC, GBG) / 2.0 i	74 kW 1993 cc	01.1987-02.1993	132000	15
FORD	SIERRA Schrägh. (GBC, GBG) / 2.0 i	80 kW 1998 cc	06.1989-02.1993	132000	15
FORD	SIERRA Schrägh. (GBC, GBG) / 2.0 i	85 kW 1993 cc	01.1987-02.1993	132000	15
FORD	SIERRA Schrägh. (GBC, GBG) / 2.0 i	88 kW 1998 cc	06.1989-02.1993	132000	15
FORD	SIERRA Schrägh. (GBC, GBG) / 2.0 i	92 kW 1998 cc	06.1989-02.1993	132000	15
FORD	SIERRA Schrägh. (GBC, GBG) / 2.0 i KAT	74 kW 2927 cc	01.1987-02.1993	132000	15
FORD	SIERRA Schrägh. (GBC, GBG) / 2.9 i	107 kW 2936 cc	08.1988-02.1993	132000	15
FORD	SIERRA Schrägh. 2.0 16V Cosw. 4x4 KAT	162 kW 1993 cc	01.1990-02.1993	132000	15
FORD	VERONA III (GAL) / 1.8 D	44 kW 1753 cc	11.1990-12.1993	132067	22
FORD	VERONA III (GAL) / 1.8 D	44 kW 1753 cc	11.1990-12.1993	132090	24



Modell
Model

Motor
Engine



Baujahr
Construction year

HÜCO-NO. Seite
Page

	Modell Model	Motor Engine	Baujahr Construction year	HÜCO-NO.	Seite Page
FORD	VERONA III (GAL) / 1.8 TD	66 kW 1753 cc	03.1992-12.1993	132067	22
FORD	VERONA III (GAL) / 1.8 TD	66 kW 1753 cc	03.1992-12.1993	132090	24
GEO	TRACKER Station Wagon / 1.9 D	50 kW 1905 cc	12.1994-12.1998	132083	29
GEO	TRACKER Station Wagon / 1.9 D	50 kW 1905 cc (XUD9)	12.1994-12.1998	132080	29
HYUNDAI	ELANTRA (XD) / 2.0	104 kW 1975 cc (G4GC)	06.2000-	132088	25
HYUNDAI	ELANTRA (XD) / 2.0	105 kW 1975 cc (G4GC)	10.2003-	132088	25
HYUNDAI	ELANTRA Stufenh. (HD) / 2.0 CVT	105 kW 1975 cc (G4GC)	06.2006-	132088	25
HYUNDAI	ELANTRA Stufenh. (XD) / 2.0	104 kW 1975 cc (G4GC)	06.2000-	132088	25
HYUNDAI	ELANTRA Stufenh. (XD) / 2.0	105 kW 1975 cc (G4GC)	10.2003-	132088	25
HYUNDAI	i30 / 2.0	105 kW 1975 cc (G4GC)	10.2007-	132088	25
HYUNDAI	i30 CW / 2.0	105 kW 1975 cc (G4GC)	02.2008-	132088	25
HYUNDAI	TIBURON Coupe / 2.0 CWT	105 kW 1975 cc (G4GC)	10.2006-	132088	25
HYUNDAI	TRAJET (FO) / 2.0	104 kW 1975 cc (G4GC)	11.2003-	132088	25
HYUNDAI	TUCSON (JM) /	104 kW 1975 cc (G4GC)	08.2004-	132088	25
HYUNDAI	TUCSON (JM) / 2.0	104 kW 1975 cc (G4GC)	08.2004-	132088	25
HYUNDAI	TUCSON (JM) / 2.0 Allrad	104 kW 1975 cc	08.2004-	132088	25
HYUNDAI	MOINCA (MING YU) / 2.0	101 kW 1975 cc (G4GC)	08.2009-	132088	25
HYUNDAI	SONATA (EF) / 2.0	101 kW 1975 cc (G4GC)	12.2002-07.2007	132088	25
HYUNDAI	TUCSON / 2.0	104 kW 1975 cc (G4GC)	05.2005-	132088	25
HYUNDAI	TUCSON / 2.0 Allrad	104 kW 1975 cc (G4GC)	05.2005-	132088	25
HYUNDAI	VERNA Schrägh. / 1.4	79 kW 1968 cc	12.2010-	132045	23
INNOCENTI	ELBA (146) / 1.7 D (146DI, 146EI)	42 kW 1697 cc (146B2.000)	08.1991-12.1996	132053	27
JAGUAR	XJ (XJ 40, 81) / 4.0	166 kW 3980 cc (G9U632)	10.1989-08.1994	132122	32
JAGUAR	XJ (XJ 40, 81) / 4.0	187 kW 3980 cc (G9U632)	10.1989-08.1994	132122	32
JEEP	GRAND CHEROKEE (ZJ) / 4.0 i (Z)	130 kW 2088 cc	10.1995-04.1999	132045	23
JEEP	GRAND CHEROKEE I (ZJ) / 4.0 i (Z)	130 kW 3960 cc	10.1995-04.1999	132045	23
KIA	CARENS II (FJ) / 2.0 CVT	102 kW 1975 cc (G4GC)	08.2004-	132088	25
KIA	CARENS Mk II (FJ) / 2.0 CWT	102 kW 1975 cc	08.2004-	132088	25
KIA	CEE'D Kombi (ED) / 2.0	105 kW 1975 cc (G4GC)	09.2007-	132088	25
KIA	CEE'D Schrägh. (ED) / 2.0	105 kW 1975 cc (G4GC)	12.2006-	132088	25
KIA	CERATO (LD) / 2.0	105 kW 1975 cc (G4GC)	04.2004-	132088	25
KIA	CERATO Stufenh. (LD) / 2.0	105 kW 1975 cc (G4GC)	04.2004-	132088	25
KIA	PRO CEE'D (ED) / 2.0	105 kW 1975 cc (G4GC)	02.2008-	132088	25
KIA	SPORTAGE (JE_) / 2.0 16V 4WD	104 kW 1975 cc (G4GC)	09.2004-	132088	25
KIA	SPORTAGE (JE_) / 2.0 i 16V	104 kW 1975 cc (G4GC)	09.2004-	132088	25
KIA (DYK)	OPTIMA / 2.0	101 kW 1975 cc (G4GC)	09.2004-	132088	25
KIA (DYK)	SPORTAGE / 2.0	101 kW 1975 cc (G4GC)	11.2007-	132088	25
KIA (DYK)	SPORTAGE / 2.0 Allrad	101 kW 1975 cc (G4GC)	11.2007-	132088	25
LADA	NIVA (2121) / 1900 D	55 kW 1905 cc (XUD9SD)	01.1999-	132081	28
LANCIA	DEDRA (835) / 1.9 TDS (835EE, 835EF)	66 kW 1995 cc	04.1989-07.1999	132084	29
LANCIA	DEDRA SW (835) / 1.9 TDS (835EE, 835EF)	66 kW 1929 cc	07.1994-07.1999	132082	29
LANCIA	DEDRA SW (835) / 1.9 TDS (835EE, 835EF)	66 kW 1929 cc	07.1994-07.1999	132084	29
LANCIA	DELTA (831AB0) / 1.9 Turbo DS	59 kW 1929 cc (831D1.000)	10.1986-12.1989	132053	27
LANCIA	DELTA I (831AB0) / 1.9 Turbo DS	59 kW 1929 cc	10.1986-12.1989	132053	27
LANCIA	DELTA II (836) / 1.9 TD (836AM, 836AN)	66 kW 1929 cc	10.1994-08.1999	132082	29
LANCIA	DELTA II (836) / 1.9 TD (836AM, 836AN)	66 kW 1929 cc	10.1994-08.1999	132084	29
LANCIA	DELTA Mk II (836) / 1.9 TD	66 kW 1929 cc	10.1994-08.1999	132082	29
LANCIA	DELTA Mk II (836) / 1.9 TD	66 kW 1929 cc	10.1994-08.1999	132084	29
LANCIA	PHEDRA (179) / 2.0 D Multijet	100 kW 1997 cc (RHR)	07.2006-	132088	25
LANCIA	PHEDRA (179) / 2.0 JTD	79 kW 1997 cc (RHM)	07.2003-	132088	25
LANCIA	PHEDRA (179) / 2.0 JTD	88 kW 1997 cc (RHK)	06.2006-	132088	25
LANCIA	PHEDRA (179) / 2.0 JTD (179AXB1A)	80 kW 1997 cc (RHW(DW10ATED4))	09.2002-	132088	25
LANCIA	PHEDRA (179) / 2.2 JTD (179AXC1A)	94 kW 2179 cc (16736)	09.2002-	132088	25
LANCIA	PRISMA (831AB0) / 1.9 Turbo D.	59 kW 1928 cc (831D1.000)	05.1985-12.1989	132053	27
LANCIA	THEMA (834) / 2000 16V (834FA)	112 kW 1697 cc	08.1992-12.1993	132040	18
LANCIA	THEMA (834) / 2000 16V Turbo	148 kW 2927 cc	10.1992-07.1994	132040	18
LANCIA	THEMA (834) / 2000 16V Turbo (834AC)	133 kW 1929 cc	12.1988-06.1990	132040	18
LANCIA	THEMA (834) / 2000 i.e.	83 kW 1928 cc	03.1986-09.1988	132040	18
LANCIA	THEMA (834) / 2000 i.e. (834B)	88 kW 1998 cc	11.1984-09.1988	132040	18
LANCIA	THEMA (834) / 2000 i.e. (834BV)	85 kW 1995 cc	09.1987-05.1992	132040	18
LANCIA	THEMA (834) / 2000 i.e. 16V (834AI)	104 kW 1968 cc	02.1989-05.1992	132040	18
LANCIA	THEMA (834) / 2000 i.e. 16V Turbo	130 kW 1995 cc	04.1989-05.1992	132040	18
LANCIA	THEMA (834) / 2000 i.e. Turbo (834C)	122 kW 1781 cc	11.1984-12.1987	132040	18
LANCIA	THEMA (834) / 2000 i.e. Turbo (834CV)	110 kW 1995 cc	07.1986-05.1990	132040	18
LANCIA	THEMA (834) / 8.32 (834F)	158 kW 2068 cc	09.1987-05.1989	132040	18
LANCIA	THEMA (834) / 8.32 (834FS)	151 kW 1598 cc	10.1987-05.1992	132040	18
LANCIA	THEMA SW 2000 i.e. 16V Turbo	130 kW 1995 cc	04.1989-03.1993	132040	18



Modell
Model

Motor
Engine



Baujahr
Construction year

HÜCO-NO. Seite
Page

LANCIA	THEMA SW 2000 i.e. 16V Turbo	133 kW 1896 cc	12.1988-06.1990	132040	18
LANCIA	THEMA SW 2000 Turbo 16V	148 kW 1995 cc	11.1992-07.1994	132040	18
LANCIA	THEMA SW (834) / 2000 16V (834FA)	112 kW 1995 cc	05.1992-07.1994	132040	18
LANCIA	THEMA SW (834) / 2000 i.e. 16V	104 kW 1995 cc	02.1989-05.1992	132040	18
LANCIA	THEMA SW (834) / 2000 Turbo	110 kW 1995 cc	01.1989-03.1992	132040	18
LANCIA	ZETA (220) / 2.0 JTD	80 kW 1997 cc (RHZ)	04.2000-09.2002	132088	25
LANCIA	ZETA (220) / 2.0 JTD (220AN5)	80 kW 1997 cc (RHW)	09.1999-09.2002	132088	25
MERCEDES-BENZ	100 Kasten (631) / D (631.332,	53 kW 1761 cc	02.1988-05.1992	132031	34
MERCEDES-BENZ	190 (W201) / D (201.122)	53 kW 1968 cc	08.1983-08.1989	132031	34
MERCEDES-BENZ	190 (W201) / D (201.122)	53 kW 1997 cc	08.1983-08.1989	132035	36
MERCEDES-BENZ	190 (W201) / D (201.122)	55 kW 1598 cc	08.1989-08.1993	132035	36
MERCEDES-BENZ	190 (W201) / D (201.126)	66 kW 1968 cc	04.1985-08.1993	132032	34
MERCEDES-BENZ	190 (W201) / D (201.126)	66 kW 2497 cc	04.1985-08.1993	132036	37
MERCEDES-BENZ	190 (W201) / D 2.0 (201.122)	53 kW 1997 cc	08.1983-08.1989	132031	34
MERCEDES-BENZ	190 (W201) / D 2.0 (201.122)	53 kW 1997 cc	08.1983-08.1989	132035	36
MERCEDES-BENZ	190 (W201) / D 2.0 (201.122)	55 kW 1997 cc	08.1989-08.1993	132035	36
MERCEDES-BENZ	190 (W201) / D 2.5 (201.126)	66 kW 2497 cc	04.1985-08.1993	132032	34
MERCEDES-BENZ	190 (W201) / D 2.5 (201.126)	66 kW 2497 cc	04.1985-08.1993	132036	37
MERCEDES-BENZ	190 (W201) / D 2.5 (201.126)	69 kW 2497 cc	08.1989-08.1993	132036	37
MERCEDES-BENZ	190 (W201) / E 2.0 (201.024)	83 kW 1968 cc	02.1985-12.1986	132038	34
MERCEDES-BENZ	190 (W201) / Turbo-D 2.5 (201.128)	90 kW 2497 cc	02.1988-08.1993	132164	38
MERCEDES-BENZ	190 (W201) / Turbo-D 2.5 (201.128)	93 kW 2497 cc	02.1988-08.1993	132164	38
MERCEDES-BENZ	190 Stufenh. Turbo-D 2.5	90 kW 2497 cc	02.1988-08.1993	132164	38
MERCEDES-BENZ	190 Stufenh. Turbo-D 2.5	93 kW 2497 cc	02.1988-08.1993	132164	38
MERCEDES-BENZ	190 Stufenh. (W201) / D (201.122)	53 kW 1997 cc	08.1983-08.1989	132031	34
MERCEDES-BENZ	190 Stufenh. (W201) / D (201.122)	53 kW 1997 cc	08.1983-08.1989	132035	36
MERCEDES-BENZ	190 Stufenh. (W201) / D (201.122)	55 kW 1997 cc	08.1989-08.1993	132035	36
MERCEDES-BENZ	190 Stufenh. (W201) / D (201.126)	66 kW 2497 cc	04.1985-08.1993	132032	34
MERCEDES-BENZ	190 Stufenh. (W201) / D (201.126)	66 kW 2497 cc	04.1985-08.1993	132036	37
MERCEDES-BENZ	190 Stufenh. (W201) / D 2.0 (201.122)	53 kW 1997 cc	08.1983-08.1989	132031	34
MERCEDES-BENZ	190 Stufenh. (W201) / D 2.0 (201.122)	53 kW 1997 cc	08.1983-08.1989	132035	36
MERCEDES-BENZ	190 Stufenh. (W201) / D 2.0 (201.122)	55 kW 1997 cc	08.1989-08.1993	132035	36
MERCEDES-BENZ	190 Stufenh. (W201) / D 2.5 (201.126)	66 kW 2497 cc	04.1985-08.1993	132032	34
MERCEDES-BENZ	190 Stufenh. (W201) / D 2.5 (201.126)	66 kW 2497 cc	04.1985-08.1993	132036	37
MERCEDES-BENZ	190 Stufenh. (W201) / D 2.5 (201.126)	69 kW 2497 cc	08.1989-08.1993	132036	37
MERCEDES-BENZ	190 Stufenh. (W201) / E 2.0 (201.024)	83 kW 1996 cc	02.1985-12.1986	132038	34
MERCEDES-BENZ	C-CLASS (W202) / C 200 CDI (202.134)	75 kW 1868 cc	03.1998-05.2000	132160	37
MERCEDES-BENZ	C-CLASS (W202) / C 200 D (202.120)	55 kW 1997 cc	03.1993-05.2000	132160	37
MERCEDES-BENZ	C-CLASS (W202) / C 200 D (202.120)	55 kW 2933 cc	03.1993-05.2000	132035	36
MERCEDES-BENZ	C-CLASS (W202) / C 200 D (202.122)	65 kW 1598 cc	10.1996-05.2000	132160	37
MERCEDES-BENZ	C-CLASS (W202) / C 220 CDI (202.133)	92 kW 2394 cc	09.1997-05.2000	132160	37
MERCEDES-BENZ	C-CLASS (W202) / C 220 D	55 kW 1781 cc	07.1996-05.2000	132160	37
MERCEDES-BENZ	C-CLASS (W202) / C 220 D (202.121)	70 kW 1968 cc	08.1993-05.2000	132160	37
MERCEDES-BENZ	C-CLASS (W203) / C 200 CDI	75 kW 1896 cc	02.2001-	132160	37
MERCEDES-BENZ	C-CLASS (W203) / C 200 CDI (203.004)	85 kW 1769 cc	09.2000-	132160	37
MERCEDES-BENZ	C-CLASS (W203) / C 220 CDI (203.006)	105 kW 2148 cc	05.2000-	132160	37
MERCEDES-BENZ	C-CLASS Break C 220 T CDI	92 kW 2151 cc	09.1997-03.2001	132160	37
MERCEDES-BENZ	C-CLASS Break (S202) / C 200 T D	65 kW 2461 cc	10.1996-03.2001	132160	37
MERCEDES-BENZ	C-CLASS Break (S202) / C 220 T D	55 kW 2155 cc	06.1996-03.2001	132160	37
MERCEDES-BENZ	C-CLASS Break (S202) / C 220 T D	70 kW 3960 cc	06.1996-09.1998	132160	37
MERCEDES-BENZ	C-CLASS Coupe (CL203) /	105 kW 1753 cc	03.2001-06.2011	132160	37
MERCEDES-BENZ	C-CLASS Coupe Sport C 220 CDI	105 kW 2148 cc	03.2001-06.2011	132160	37
MERCEDES-BENZ	C-CLASS Kombi C 220 T CDI	92 kW 2151 cc	09.1997-03.2001	132160	37
MERCEDES-BENZ	C-CLASS Kombi (S202) / C 200 T D	65 kW 1997 cc	10.1996-03.2001	132160	37
MERCEDES-BENZ	C-CLASS Kombi (S202) / C 220 T D	55 kW 2155 cc	06.1996-03.2001	132160	37
MERCEDES-BENZ	C-CLASS Kombi (S202) / C 220 T D	70 kW 2155 cc	06.1996-09.1998	132160	37
MERCEDES-BENZ	C-CLASS Sportcoupe C 220 CDI	105 kW 2148 cc	03.2001-06.2011	132160	37
MERCEDES-BENZ	C-CLASS Sportcoupe C 220 CDI	105 kW 2148 cc	03.2001-06.2011	132160	37
MERCEDES-BENZ	C-CLASS Stufenh. C 200 CDI	75 kW 2151 cc	03.1998-05.2000	132160	37
MERCEDES-BENZ	C-CLASS Stufenh. C 200 CDI	85 kW 2148 cc	09.2000-	132160	37
MERCEDES-BENZ	C-CLASS Stufenh. C 200 D	55 kW 1997 cc	03.1993-05.2000	132035	36
MERCEDES-BENZ	C-CLASS Stufenh. C 200 D	55 kW 1997 cc	03.1993-05.2000	132160	37
MERCEDES-BENZ	C-CLASS Stufenh. C 200 D	65 kW 1997 cc	10.1996-05.2000	132160	37
MERCEDES-BENZ	C-CLASS Stufenh. C 220 CDI	105 kW 2148 cc	05.2000-	132160	37
MERCEDES-BENZ	C-CLASS Stufenh. C 220 CDI	92 kW 2151 cc	09.1997-05.2000	132160	37
MERCEDES-BENZ	C-CLASS Stufenh. C 220 D	70 kW 2155 cc	08.1993-05.2000	132160	37
MERCEDES-BENZ	C-CLASS Stufenh. (W202) / C 220 D	55 kW 2155 cc	07.1996-05.2000	132160	37



Modell
Model

Motor
Engine



Baujahr
Construction year

HÜCO-NO. Seite
Page

	Modell Model	Motor Engine	Baujahr Construction year	HÜCO-NO.	Seite Page
MERCEDES-BENZ	C-CLASS Stufenh. (W203) / C 200 CDI	75 kW 2148 cc	02.2001-	132160	37
MERCEDES-BENZ	C-CLASS T-Model C 200 CDI	85 kW 1870 cc	03.2001-08.2007	132160	37
MERCEDES-BENZ	C-CLASS T-Model C 220 CDI	105 kW 2148 cc	03.2001-08.2007	132160	37
MERCEDES-BENZ	C-CLASS T-Model (S203) / C 200 CDI	75 kW 2148 cc	03.2001-08.2007	132160	37
MERCEDES-BENZ	C-KLASSE (W202) / C 200 CDI (202.134)	75 kW 2151 cc	03.1998-05.2000	132160	37
MERCEDES-BENZ	C-KLASSE (W202) / C 200 D (202.120)	55 kW 1997 cc	03.1993-05.2000	132035	36
MERCEDES-BENZ	C-KLASSE (W202) / C 200 D (202.120)	55 kW 1997 cc	03.1993-05.2000	132160	37
MERCEDES-BENZ	C-KLASSE (W202) / C 200 D (202.122)	65 kW 1997 cc	10.1996-05.2000	132160	37
MERCEDES-BENZ	C-KLASSE (W202) / C 220 CDI (202.133)	92 kW 2151 cc	09.1997-05.2000	132160	37
MERCEDES-BENZ	C-KLASSE (W202) / C 220 D	55 kW 2155 cc	07.1996-05.2000	132160	37
MERCEDES-BENZ	C-KLASSE (W202) / C 220 D (202.121)	70 kW 2155 cc	08.1993-05.2000	132160	37
MERCEDES-BENZ	C-KLASSE (W203) / C 200 CDI	75 kW 2148 cc	02.2001-	132160	37
MERCEDES-BENZ	C-KLASSE (W203) / C 200 CDI (203.004)	85 kW 2148 cc	09.2000-	132160	37
MERCEDES-BENZ	C-KLASSE (W203) / C 220 CDI (203.006)	105 kW 2148 cc	05.2000-	132160	37
MERCEDES-BENZ	C-KLASSE Kombi C 220 T CDI	92 kW 2151 cc	09.1997-03.2001	132160	37
MERCEDES-BENZ	C-KLASSE Kombi (S202) /	65 kW 1997 cc	10.1996-03.2001	132160	37
MERCEDES-BENZ	C-KLASSE Kombi (S202) /	70 kW 2155 cc	06.1996-09.1998	132160	37
MERCEDES-BENZ	C-KLASSE Kombi (S202) / C 220 T D	55 kW 2155 cc	06.1996-03.2001	132160	37
MERCEDES-BENZ	C-KLASSE Kombi (S203) /	105 kW 2148 cc	03.2001-08.2007	132160	37
MERCEDES-BENZ	C-KLASSE Kombi (S203) /	85 kW 2148 cc	03.2001-08.2007	132160	37
MERCEDES-BENZ	C-KLASSE Kombi (S203) / C 200 CDI	75 kW 2148 cc	03.2001-08.2007	132160	37
MERCEDES-BENZ	C-KLASSE Sportcoupe C 220 CDI	105 kW 2148 cc	03.2001-06.2011	132160	37
MERCEDES-BENZ	COUPE (C123) / 300 C Turbo-D (123.153)	92 kW 2299 cc	09.1981-07.1985	132032	34
MERCEDES-BENZ	G-CLASS (W460) / 240 GD (460,3)	53 kW 2399 cc	03.1979-08.1987	132038	34
MERCEDES-BENZ	G-CLASS (W460) / 240 GD (460,3)	53 kW 2445 cc	03.1979-08.1987	132030	33
MERCEDES-BENZ	G-CLASS (W460) / 250 GD (460,3)	62 kW 1608 cc	10.1987-12.1992	132032	34
MERCEDES-BENZ	G-CLASS (W460) / 250 GD (460,3)	62 kW 2497 cc	10.1987-12.1992	132038	34
MERCEDES-BENZ	G-CLASS (W460) / 250 GD (460,3)	68 kW 2299 cc	12.1988-08.1992	132032	34
MERCEDES-BENZ	G-CLASS (W460) / 250 GD (460,3)	68 kW 2497 cc	12.1988-08.1992	132038	34
MERCEDES-BENZ	G-CLASS (W460) / 300 GD (460,3)	65 kW 1796 cc	12.1979-12.1991	132032	34
MERCEDES-BENZ	G-CLASS (W460) / 300 GD (460,3)	65 kW 2998 cc	12.1979-12.1991	132038	34
MERCEDES-BENZ	G-KLASSE (W460) / 240 GD (460,3)	53 kW 2399 cc	03.1979-08.1987	132030	33
MERCEDES-BENZ	G-KLASSE (W460) / 240 GD (460,3)	53 kW 2399 cc	03.1979-08.1987	132038	34
MERCEDES-BENZ	G-KLASSE (W460) / 250 GD (460,3)	62 kW 2497 cc	10.1987-12.1992	132032	34
MERCEDES-BENZ	G-KLASSE (W460) / 250 GD (460,3)	62 kW 2497 cc	10.1987-12.1992	132038	34
MERCEDES-BENZ	G-KLASSE (W460) / 250 GD (460,3)	68 kW 2497 cc	12.1988-08.1992	132032	34
MERCEDES-BENZ	G-KLASSE (W460) / 250 GD (460,3)	68 kW 2497 cc	12.1988-08.1992	132038	34
MERCEDES-BENZ	G-KLASSE (W460) / 300 GD (460,3)	65 kW 2998 cc	12.1979-12.1991	132032	34
MERCEDES-BENZ	G-KLASSE (W460) / 300 GD (460,3)	65 kW 2998 cc	12.1979-12.1991	132038	34
MERCEDES-BENZ	KOMBI Break 300 T Turbo-D	92 kW 2998 cc	10.1980-11.1985	132032	34
MERCEDES-BENZ	KOMBI Break 300 T Turbo-D	92 kW 2998 cc	10.1980-11.1985	132038	34
MERCEDES-BENZ	KOMBI Break (S123) / 240 T D	48 kW 2399 cc	09.1977-02.1979	132030	33
MERCEDES-BENZ	KOMBI Break (S123) / 240 T D	48 kW 2399 cc	09.1977-02.1979	132038	34
MERCEDES-BENZ	KOMBI Break (S123) / 240 T D	53 kW 2399 cc	03.1979-12.1985	132038	34
MERCEDES-BENZ	KOMBI Break (S123) / 240 T D	53 kW 2998 cc	03.1979-12.1985	132030	33
MERCEDES-BENZ	KOMBI Break (S123) / 300 T D	59 kW 2399 cc	09.1977-10.1985	132032	34
MERCEDES-BENZ	KOMBI Break (S123) / 300 T D	59 kW 2998 cc	09.1977-10.1985	132038	34
MERCEDES-BENZ	KOMBI Break (S123) / 300 T D	65 kW 2998 cc	03.1979-11.1985	132032	34
MERCEDES-BENZ	KOMBI Break (S123) / 300 T D	65 kW 2998 cc	03.1979-11.1985	132038	34
MERCEDES-BENZ	KOMBI Break (S124) / 200 T D	53 kW 1997 cc	09.1985-08.1991	132031	34
MERCEDES-BENZ	KOMBI Break (S124) / 200 T D	53 kW 1997 cc	09.1985-08.1991	132034	35
MERCEDES-BENZ	KOMBI Break (S124) / 200 T D	53 kW 1997 cc	09.1985-08.1991	132038	34
MERCEDES-BENZ	KOMBI Break (S124) / 200 T D	53 kW 3405 cc	09.1985-08.1991	132030	33
MERCEDES-BENZ	KOMBI Break (S124) / 200 T D	55 kW 1997 cc	09.1988-08.1991	132030	33
MERCEDES-BENZ	KOMBI Break (S124) / 200 T D	55 kW 1997 cc	09.1988-08.1991	132031	34
MERCEDES-BENZ	KOMBI Break (S124) / 200 T D	55 kW 1997 cc	09.1988-08.1991	132034	35
MERCEDES-BENZ	KOMBI Break (S124) / 200 T D	55 kW 1997 cc	09.1988-08.1991	132038	34
MERCEDES-BENZ	KOMBI Break (S124) / 250 T D	66 kW 1997 cc	09.1985-06.1993	132032	34
MERCEDES-BENZ	KOMBI Break (S124) / 250 T D	66 kW 2497 cc	09.1985-06.1993	132036	37
MERCEDES-BENZ	KOMBI Break (S124) / 250 T D	66 kW 2497 cc	09.1985-06.1993	132038	34
MERCEDES-BENZ	KOMBI Break (S124) / 250 T D	69 kW 2497 cc	01.1989-06.1993	132036	37
MERCEDES-BENZ	KOMBI Break (S124) / 250 T D	69 kW 3210 cc	01.1989-06.1993	132038	34
MERCEDES-BENZ	KOMBI Break (S124) / 300 T D	80 kW 2370 cc	09.1986-06.1993	132031	34
MERCEDES-BENZ	KOMBI Break (S124) / 300 T D	80 kW 2996 cc	09.1986-06.1993	132037	37
MERCEDES-BENZ	KOMBI Break (S124) / 300 T D	81 kW 2996 cc	01.1989-06.1993	132031	34
MERCEDES-BENZ	KOMBI Break (S124) / 300 T D	81 kW 2996 cc	01.1989-06.1993	132037	37
MERCEDES-BENZ	KOMBI Break (S124) / 300 T D	83 kW 2996 cc	01.1989-06.1993	132031	34



Modell
Model

Motor
Engine



Baujahr
Construction year

HÜCO-NO. Seite
Page

MERCEDES-BENZ	KOMBI Break (S124) / 300 T D	83 kW 2996 cc	01.1989-06.1993	132037	37
MERCEDES-BENZ	KOMBI Kombi 300 T Turbo-D	92 kW 2998 cc	10.1980-11.1985	132032	34
MERCEDES-BENZ	KOMBI Kombi 300 T Turbo-D	92 kW 2998 cc	10.1980-11.1985	132038	34
MERCEDES-BENZ	KOMBI Kombi (S123) / 240 T D	48 kW 2399 cc	09.1977-02.1979	132030	33
MERCEDES-BENZ	KOMBI Kombi (S123) / 240 T D	48 kW 2399 cc	09.1977-02.1979	132038	34
MERCEDES-BENZ	KOMBI Kombi (S123) / 240 T D	53 kW 2399 cc	03.1979-12.1985	132030	33
MERCEDES-BENZ	KOMBI Kombi (S123) / 240 T D	53 kW 2399 cc	03.1979-12.1985	132038	34
MERCEDES-BENZ	KOMBI Kombi (S123) / 300 T D	59 kW 2998 cc	09.1977-10.1985	132032	34
MERCEDES-BENZ	KOMBI Kombi (S123) / 300 T D	59 kW 2998 cc	09.1977-10.1985	132038	34
MERCEDES-BENZ	KOMBI Kombi (S123) / 300 T D	65 kW 2998 cc	03.1979-11.1985	132032	34
MERCEDES-BENZ	KOMBI Kombi (S123) / 300 T D	65 kW 2998 cc	03.1979-11.1985	132038	34
MERCEDES-BENZ	KOMBI Kombi (S124) / 200 T D	53 kW 1997 cc	09.1985-08.1991	132030	33
MERCEDES-BENZ	KOMBI Kombi (S124) / 200 T D	53 kW 1997 cc	09.1985-08.1991	132031	34
MERCEDES-BENZ	KOMBI Kombi (S124) / 200 T D	53 kW 1997 cc	09.1985-08.1991	132034	35
MERCEDES-BENZ	KOMBI Kombi (S124) / 200 T D	53 kW 1997 cc	09.1985-08.1991	132038	34
MERCEDES-BENZ	KOMBI Kombi (S124) / 200 T D	55 kW 1997 cc	09.1988-08.1991	132030	33
MERCEDES-BENZ	KOMBI Kombi (S124) / 200 T D	55 kW 1997 cc	09.1988-08.1991	132031	34
MERCEDES-BENZ	KOMBI Kombi (S124) / 200 T D	55 kW 1997 cc	09.1988-08.1991	132034	35
MERCEDES-BENZ	KOMBI Kombi (S124) / 200 T D	55 kW 1997 cc	09.1988-08.1991	132038	34
MERCEDES-BENZ	KOMBI Kombi (S124) / 250 T D	66 kW 2497 cc	09.1985-06.1993	132032	34
MERCEDES-BENZ	KOMBI Kombi (S124) / 250 T D	66 kW 2497 cc	09.1985-06.1993	132036	37
MERCEDES-BENZ	KOMBI Kombi (S124) / 250 T D	66 kW 2497 cc	09.1985-06.1993	132038	34
MERCEDES-BENZ	KOMBI Kombi (S124) / 250 T D	69 kW 2497 cc	01.1989-06.1993	132036	37
MERCEDES-BENZ	KOMBI Kombi (S124) / 250 T D	69 kW 2497 cc	01.1989-06.1993	132038	34
MERCEDES-BENZ	KOMBI Kombi (S124) / 300 T D	80 kW 2996 cc	09.1986-06.1993	132031	34
MERCEDES-BENZ	KOMBI Kombi (S124) / 300 T D	80 kW 2996 cc	09.1986-06.1993	132037	37
MERCEDES-BENZ	KOMBI Kombi (S124) / 300 T D	81 kW 2996 cc	01.1989-06.1993	132031	34
MERCEDES-BENZ	KOMBI Kombi (S124) / 300 T D	81 kW 2996 cc	01.1989-06.1993	132037	37
MERCEDES-BENZ	KOMBI Kombi (S124) / 300 T D	83 kW 2996 cc	01.1989-06.1993	132031	34
MERCEDES-BENZ	KOMBI Kombi (S124) / 300 T D	83 kW 2996 cc	01.1989-06.1993	132037	37
MERCEDES-BENZ	SPRINTER 2-t Bus (901, 902) / 210 D	75 kW 2299 cc	03.1997-04.2000	132038	34
MERCEDES-BENZ	SPRINTER 2-t Kasten (901, 902) / 210 D	75 kW 1998 cc	01.1997-04.2000	132038	34
MERCEDES-BENZ	SPRINTER 2-t Pritsche / 210 D	75 kW 2874 cc	01.1997-04.2000	132038	34
MERCEDES-BENZ	SPRINTER 3-t Bus (903) / 308 D	58 kW 2299 cc	02.1995-04.2000	132038	34
MERCEDES-BENZ	SPRINTER 3-t Bus (903) / 310 D 4x4	75 kW 2299 cc	05.1997-08.2002	132038	34
MERCEDES-BENZ	SPRINTER 3-t Kasten (903) / 308 D 2.3	58 kW 2399 cc	02.1995-04.2000	132038	34
MERCEDES-BENZ	SPRINTER 3-t Kasten (903) / 308 D 2.3	60 kW 1461 cc	02.1995-04.2000	132038	34
MERCEDES-BENZ	SPRINTER 3-t Kasten (903) / 310 D 2.9	75 kW 2299 cc	02.1995-04.2000	132038	34
MERCEDES-BENZ	SPRINTER 3-t Pritsche (903) / 308 D 2.3	60 kW 2874 cc	11.1996-04.2000	132038	34
MERCEDES-BENZ	SPRINTER 3-t Pritsche (903) / 310 D 2.9	75 kW 2874 cc	01.1997-04.2000	132038	34
MERCEDES-BENZ	Stufenh. (W123) / 200 D	44 kW 1988 cc	03.1979-11.1985	132030	33
MERCEDES-BENZ	Stufenh. (W123) / 200 D	44 kW 1988 cc	03.1979-11.1985	132038	34
MERCEDES-BENZ	Stufenh. (W123) / 200 D (123.120)	40 kW 1527 cc	07.1976-02.1979	132030	33
MERCEDES-BENZ	Stufenh. (W123) / 200 D (123.120)	40 kW 1988 cc	07.1976-02.1979	132038	34
MERCEDES-BENZ	Stufenh. (W123) / 240 D (123.123)	48 kW 2399 cc	02.1976-02.1979	132030	33
MERCEDES-BENZ	Stufenh. (W123) / 240 D (123.123)	48 kW 2399 cc	02.1976-02.1979	132038	34
MERCEDES-BENZ	Stufenh. (W123) / 240 D (123.123)	53 kW 1998 cc	03.1979-11.1985	132038	34
MERCEDES-BENZ	Stufenh. (W123) / 300 D (123.130)	59 kW 2399 cc	02.1976-07.1980	132032	34
MERCEDES-BENZ	Stufenh. (W123) / 300 D (123.130)	59 kW 2998 cc	02.1976-07.1980	132038	34
MERCEDES-BENZ	Stufenh. (W123) / 300 D (123.130)	65 kW 2998 cc	03.1979-11.1985	132032	34
MERCEDES-BENZ	Stufenh. (W123) / 300 D (123.130)	65 kW 2998 cc	03.1979-11.1985	132038	34
MERCEDES-BENZ	Stufenh. (W123) / 300 Turbo-D	92 kW 2998 cc	08.1981-07.1985	132032	34
MERCEDES-BENZ	Stufenh. (W123) / 300 Turbo-D	92 kW 2998 cc	08.1981-07.1985	132038	34
MERCEDES-BENZ	Stufenh. (W124) / 200 D (124.120)	53 kW 1991 cc	12.1984-08.1989	132031	34
MERCEDES-BENZ	Stufenh. (W124) / 200 D (124.120)	53 kW 1997 cc	12.1984-08.1989	132034	35
MERCEDES-BENZ	Stufenh. (W124) / 200 D (124.120)	53 kW 1997 cc	12.1984-08.1989	132038	34
MERCEDES-BENZ	Stufenh. (W124) / 200 D (124.120)	55 kW 1997 cc	08.1989-06.1993	132034	35
MERCEDES-BENZ	Stufenh. (W124) / 200 D (124.120)	55 kW 1997 cc	08.1989-06.1993	132038	34
MERCEDES-BENZ	Stufenh. (W124) / 250 D (124.125)	66 kW 1997 cc	04.1985-06.1993	132032	34
MERCEDES-BENZ	Stufenh. (W124) / 250 D (124.125)	66 kW 2497 cc	04.1985-06.1993	132036	37
MERCEDES-BENZ	Stufenh. (W124) / 250 D (124.125)	66 kW 2497 cc	04.1985-06.1993	132038	34
MERCEDES-BENZ	Stufenh. (W124) / 250 D (124.125)	69 kW 2497 cc	01.1989-06.1993	132032	34
MERCEDES-BENZ	Stufenh. (W124) / 250 D (124.125)	69 kW 2497 cc	01.1989-06.1993	132036	37
MERCEDES-BENZ	Stufenh. (W124) / 250 D (124.125)	69 kW 2497 cc	01.1989-06.1993	132038	34
MERCEDES-BENZ	Stufenh. (W124) / 300 D (124.130)	80 kW 1598 cc	12.1984-08.1989	132031	34
MERCEDES-BENZ	Stufenh. (W124) / 300 D (124.130)	80 kW 2996 cc	12.1984-08.1989	132037	37
MERCEDES-BENZ	Stufenh. (W124) / 300 D (124.130)	81 kW 2996 cc	06.1990-06.1993	132037	37



Modell
Model

Motor
Engine



Baujahr
Construction year

HÜCO-NO. Seite
Page

	Modell Model	Motor Engine	Baujahr Construction year	HÜCO-NO.	Seite Page
MERCEDES-BENZ	Stufenh. (W124) / 300 D (124.130)	83 kW 2996 cc	08.1989-06.1993	132037	37
MERCEDES-BENZ	Stufenh. (W124) / 300 D 4-matic	80 kW 2996 cc	09.1986-08.1992	132031	34
MERCEDES-BENZ	Stufenh. (W124) / 300 D 4-matic	80 kW 2996 cc	09.1986-08.1992	132037	37
MERCEDES-BENZ	Stufenh. (W124) / 300 D 4-matic	83 kW 2996 cc	08.1989-06.1993	132031	34
MERCEDES-BENZ	Stufenh. (W124) / 300 D 4-matic	83 kW 2996 cc	08.1989-06.1993	132037	37
MERCEDES-BENZ	T1 Bus (601) / 207 D 2.4	53 kW 1598 cc	07.1982-01.1990	132030	33
MERCEDES-BENZ	T1 Bus (601) / 207 D 2.4	53 kW 2376 cc	07.1982-01.1990	132038	34
MERCEDES-BENZ	T1 Bus (601) / 208 D 2.3	58 kW 1870 cc	10.1988-02.1996	132030	33
MERCEDES-BENZ	T1 Bus (601) / 208 D 2.3	58 kW 2299 cc	10.1988-02.1996	132038	34
MERCEDES-BENZ	T1 Bus (601) / 208 D 2.3	60 kW 2088 cc	10.1988-02.1996	132030	33
MERCEDES-BENZ	T1 Bus (601) / 208 D 2.3	60 kW 2299 cc	10.1988-02.1996	132038	34
MERCEDES-BENZ	T1 Bus (601) / 209 D 2.9	65 kW 1998 cc	12.1982-01.1990	132032	34
MERCEDES-BENZ	T1 Bus (601) / 209 D 2.9	65 kW 2998 cc	12.1982-01.1990	132038	34
MERCEDES-BENZ	T1 Bus (601) / 210 D 2.8	70 kW 1998 cc	11.1988-02.1996	132038	34
MERCEDES-BENZ	T1 Bus (601) / 210 D 2.8	72 kW 2874 cc	11.1988-02.1996	132038	34
MERCEDES-BENZ	T1 Bus (602) / 308 D 2.3	58 kW 2998 cc	05.1990-02.1996	132038	34
MERCEDES-BENZ	T1 Bus (602) / 308 D 2.3	60 kW 2088 cc	06.1989-02.1996	132038	34
MERCEDES-BENZ	T1 Bus (602) / 310 D 2.9	70 kW 2874 cc	06.1989-02.1996	132038	34
MERCEDES-BENZ	T1 Bus (602) / 310 D 2.9	72 kW 2874 cc	06.1990-02.1996	132038	34
MERCEDES-BENZ	T1 Kasten (601) / 207 D 2.4	53 kW 2399 cc	06.1982-01.1990	132038	34
MERCEDES-BENZ	T1 Kasten (601) / 207 D 2.4	53 kW 2497 cc	06.1982-01.1990	132030	33
MERCEDES-BENZ	T1 Kasten (601) / 208 D 2.3	58 kW 1998 cc	11.1988-02.1996	132030	33
MERCEDES-BENZ	T1 Kasten (601) / 208 D 2.3	58 kW 2299 cc	11.1988-02.1996	132038	34
MERCEDES-BENZ	T1 Kasten (601) / 208 D 2.3	60 kW 1905 cc	10.1988-02.1996	132030	33
MERCEDES-BENZ	T1 Kasten (601) / 209 D 2.9	65 kW 2998 cc	12.1982-01.1990	132038	34
MERCEDES-BENZ	T1 Kasten (601) / 209 D 2.9	65 kW 5967 cc	12.1982-01.1990	132032	34
MERCEDES-BENZ	T1 Kasten (601) / 210 D 2.8	70 kW 1993 cc	10.1988-02.1996	132038	34
MERCEDES-BENZ	T1 Kasten (601) / 210 D 2.8	72 kW 1698 cc	10.1988-02.1996	132038	34
MERCEDES-BENZ	T1 Kasten (602) / 307 D 2.4	53 kW 2399 cc	10.1982-01.1990	132030	33
MERCEDES-BENZ	T1 Kasten (602) / 307 D 2.4	53 kW 2399 cc	10.1982-01.1990	132038	34
MERCEDES-BENZ	T1 Kasten (602) / 308 D 2.3	60 kW 2874 cc	06.1989-02.1996	132038	34
MERCEDES-BENZ	T1 Kasten (602) / 309 D 3.0	65 kW 2399 cc	10.1982-01.1990	132032	34
MERCEDES-BENZ	T1 Kasten (602) / 309 D 3.0	65 kW 2998 cc	10.1982-01.1990	132038	34
MERCEDES-BENZ	T1 Kasten (602) / 310 D 2.9	70 kW 2998 cc	06.1989-02.1996	132038	34
MERCEDES-BENZ	T1 Kasten (602) / 310 D 2.9	72 kW 1905 cc	06.1989-02.1996	132038	34
MERCEDES-BENZ	T1 Pritsche (601) / 207 D 2.4	53 kW 2399 cc	12.1977-10.1989	132038	34
MERCEDES-BENZ	T1 Pritsche (601) / 207 D 2.4	53 kW 2874 cc	12.1977-10.1989	132030	33
MERCEDES-BENZ	T1 Pritsche (601) / 208 D 2.3	58 kW 1870 cc	11.1988-02.1996	132030	33
MERCEDES-BENZ	T1 Pritsche (601) / 208 D 2.3	58 kW 2299 cc	11.1988-02.1996	132038	34
MERCEDES-BENZ	T1 Pritsche (601) / 208 D 2.3	60 kW 2299 cc	06.1989-02.1996	132038	34
MERCEDES-BENZ	T1 Pritsche (601) / 208 D 2.3	60 kW 2874 cc	06.1989-02.1996	132030	33
MERCEDES-BENZ	T1 Pritsche (601) / 209 D 2.9	65 kW 2998 cc	12.1982-01.1990	132032	34
MERCEDES-BENZ	T1 Pritsche (601) / 209 D 2.9	65 kW 2998 cc	12.1982-01.1990	132038	34
MERCEDES-BENZ	T1 Pritsche (601) / 210 D 2.8	72 kW 2969 cc	11.1988-02.1996	132038	34
MERCEDES-BENZ	T1 Pritsche (601) / 210 D 2.9	70 kW 2933 cc	11.1988-02.1996	132038	34
MERCEDES-BENZ	T1 Pritsche (602) / 307 D 2.4	53 kW 2299 cc	06.1982-01.1990	132030	33
MERCEDES-BENZ	T1 Pritsche (602) / 307 D 2.4	53 kW 2399 cc	06.1982-01.1990	132038	34
MERCEDES-BENZ	T1 Pritsche (602) / 308 D 2.3	58 kW 2299 cc	06.1989-02.1996	132038	34
MERCEDES-BENZ	T1 Pritsche (602) / 308 D 2.3	60 kW 2874 cc	06.1989-02.1996	132038	34
MERCEDES-BENZ	T1 Pritsche (602) / 309 D 3.0	65 kW 2399 cc	10.1982-01.1990	132032	34
MERCEDES-BENZ	T1 Pritsche (602) / 309 D 3.0	65 kW 2998 cc	10.1982-01.1990	132038	34
MERCEDES-BENZ	T1 Pritsche (602) / 310 D 2.9	70 kW 2461 cc	06.1989-02.1996	132038	34
MERCEDES-BENZ	T1 Pritsche (602) / 310 D 2.9	72 kW 2874 cc	06.1989-02.1996	132038	34
MERCEDES-BENZ	V-CLASS (638/2) / V 230 TD (638.274)	72 kW 1997 cc	09.1996-07.2003	132038	34
MERCEDES-BENZ	VITO Bus (638) / 108 D 2.3 (638.164)	58 kW 1905 cc	02.1996-07.2003	132038	34
MERCEDES-BENZ	VITO Bus (638) / 110 TD 2.3 (638.174)	72 kW 2299 cc	02.1996-07.2003	132038	34
MERCEDES-BENZ	VITO Kasten (638) / 108 D 2.3	58 kW 2500 cc	03.1997-07.2003	132038	34
MERCEDES-BENZ	VITO Kasten (638) / 110 D 2.3 (72 kW 2299 cc	03.1997-07.2003	132038	34
MERCEDES-BENZ	V-KLASSE (638/2) / V 230 TD (638.274)	72 kW 2299 cc	09.1996-07.2003	132038	34
MITSUBISHI	GALANT FORTIS / 2.0 DI-D	103 kW 1968 cc	01.2008-	132106	24
MITSUBISHI	GALANT FORTIS / 2.0 DI-D	103 kW 1968 cc	01.2008-	132107	24
MITSUBISHI	GALANT FORTIS / 2.0 DI-D	103 kW 1968 cc	01.2008-	132128	25
MITSUBISHI	GALANT FORTIS / 2.0 DI-D	103 kW 1968 cc	01.2008-	132129	25
MITSUBISHI	GALANT FORTIS / 2.0 DI-D	103 kW 1968 cc (BKD)	01.2008-	132104	24
MITSUBISHI	GALANT FORTIS SPORTB. / 2.0 DI-D	103 kW 1968 cc	06.2008-	132106	24
MITSUBISHI	GALANT FORTIS SPORTB. / 2.0 DI-D	103 kW 1968 cc	06.2008-	132107	24
MITSUBISHI	GALANT FORTIS SPORTB. / 2.0 DI-D	103 kW 1968 cc	06.2008-	132128	25



Modell
Model

Motor
Engine



Baujahr
Construction year

HÜCO-NO. Seite
Page

mitsubishi	GALANT FORTIS SPORTB. / 2.0 DI-D	103 kW 1968 cc	06.2008-	132129	25
mitsubishi	GALANT FORTIS SPORTB. / 2.0 DI-D	103 kW 1968 cc (BKD)	06.2008-	132104	24
mitsubishi	GALANT Mk VI Station Wagon 2.4 GDI	106 kW 2351 cc (G9U754)	09.2000-10.2003	132122	32
mitsubishi	GALANT VI Station Wagon 2.4 GDI	106 kW 2351 cc	09.2000-10.2003	132122	32
mitsubishi	LANCER SPORTBACK (CX_A) / 2.0 DI-D	103 kW 1968 cc	06.2008-	132104	24
mitsubishi	LANCER SPORTBACK (CX_A) / 2.0 DI-D	103 kW 1968 cc	06.2008-	132106	24
mitsubishi	LANCER SPORTBACK (CX_A) / 2.0 DI-D	103 kW 1968 cc	06.2008-	132107	24
mitsubishi	LANCER SPORTBACK (CX_A) / 2.0 DI-D	103 kW 1968 cc	06.2008-	132128	25
mitsubishi	LANCER SPORTBACK (CX_A) / 2.0 DI-D	103 kW 1968 cc	06.2008-	132129	25
mitsubishi	LANCER Stufenh. (CY/Z_A) / 2.0 DI-D	103 kW 1968 cc	01.2008-	132104	24
mitsubishi	LANCER Stufenh. (CY/Z_A) / 2.0 DI-D	103 kW 1968 cc	01.2008-	132106	24
mitsubishi	LANCER Stufenh. (CY/Z_A) / 2.0 DI-D	103 kW 1968 cc	01.2008-	132107	24
mitsubishi	LANCER Stufenh. (CY/Z_A) / 2.0 DI-D	103 kW 1968 cc	01.2008-	132128	25
mitsubishi	LANCER Stufenh. (CY/Z_A) / 2.0 DI-D	103 kW 1968 cc	01.2008-	132129	25
NISSAN	ALMERA II (N16) / 1.5 dCi	60 kW 1461 cc (K9K722)	01.2003-	132121	31
NISSAN	ALMERA II (N16) / 2.2 dCi	100 kW 2184 cc	09.2003-	132121	31
NISSAN	ALMERA II Hatchback (N16) / 1.5 dCi	60 kW 1461 cc (K9K722)	01.2003-	132121	31
NISSAN	ALMERA II Hatchback (N16) / 2.2 dCi	100 kW 2184 cc	09.2003-	132121	31
NISSAN	ALMERA II Hatchback (N16) / 2.2 dCi	82 kW 2490 cc	09.2003-	132121	31
NISSAN	ALMERA Mk II (N16) / 1.5 dCi	60 kW 1461 cc	01.2003-	132121	31
NISSAN	ALMERA Mk II (N16) / 2.2 dCi	100 kW 2184 cc	09.2003-	132121	31
NISSAN	ALMERA Mk II (N16) / 2.2 dCi	82 kW 2184 cc	09.2003-	132121	31
NISSAN	ALMERA TINO (V10) / 2.2 dCi	100 kW 2184 cc	09.2003-	132121	31
NISSAN	ALMERA TINO (V10) / 2.2 dCi	82 kW 2184 cc	09.2003-	132121	31
NISSAN	INTERSTAR Bus (X70) / dCi 150	107 kW 2464 cc (G9U632)	09.2006-	132122	32
NISSAN	INTERSTAR Bus (X70) / dCi 80	60 kW 1870 cc (F9Q772)	07.2002-	132121	31
NISSAN	INTERSTAR Kasten (X70) / dCi 120	88 kW 2464 cc (G9U650)	09.2006-	132122	32
NISSAN	INTERSTAR Kasten (X70) / dCi 150	107 kW 2464 cc (G9U632)	09.2006-	132122	32
NISSAN	INTERSTAR Kasten (X70) / dCi 80	60 kW 1870 cc (F9Q772)	07.2002-	132121	31
NISSAN	KUBISTAR (X76) / 1.5 dCi	48 kW 1461 cc (K9K704)	08.2003-	132121	31
NISSAN	KUBISTAR (X76) / 1.5 dCi	60 kW 1461 cc (K9K722)	08.2003-	132121	31
NISSAN	KUBISTAR Kasten / 1.5 dCi	48 kW 1461 cc (K9K704)	08.2003-	132121	31
NISSAN	KUBISTAR Kasten / 1.5 dCi	60 kW 1461 cc (K9K722)	08.2003-	132121	31
NISSAN	MARCH III (K12) / 1.5 dCi	48 kW 1461 cc (K9K704)	01.2003-	132121	31
NISSAN	MARCH III (K12) / 1.5 dCi	60 kW 1461 cc (K9K722)	09.2003-	132121	31
NISSAN	MICRA III (K12) / 1.5 dCi	48 kW 1461 cc	01.2003-	132121	31
NISSAN	MICRA III (K12) / 1.5 dCi	60 kW 1461 cc	09.2003-	132121	31
NISSAN	NOTE (E11) / 1.5 dCi	50 kW 1461 cc (K9K700)	03.2006-	132121	31
NISSAN	PRIMASTAR Bus (X83) / dCi 100	74 kW 1870 cc (F9Q760)	03.2001-	132121	31
NISSAN	PRIMASTAR Bus (X83) / dCi 120	84 kW 2464 cc	09.2006-	132122	32
NISSAN	PRIMASTAR Bus (X83) / dCi 140	99 kW 2463 cc	07.2003-	132121	31
NISSAN	PRIMASTAR Bus (X83) / dCi 150	107 kW 2464 cc (G9U632)	09.2006-	132122	32
NISSAN	PRIMASTAR Bus (X83) / dCi 80	60 kW 1870 cc (F9Q762)	03.2001-	132121	31
NISSAN	PRIMASTAR Kasten (X83) / dCi 100	74 kW 1870 cc (F9Q760)	09.2002-	132121	31
NISSAN	PRIMASTAR Kasten (X83) / dCi 120	84 kW 1995 cc	09.2006-	132122	32
NISSAN	PRIMASTAR Kasten (X83) / dCi 140	99 kW 2184 cc	07.2003-	132121	31
NISSAN	PRIMASTAR Kasten (X83) / dCi 150	107 kW 2464 cc (G9U632)	09.2006-	132122	32
NISSAN	PRIMASTAR Kasten (X83) / dCi 80	60 kW 1870 cc (F9Q762)	09.2002-	132121	31
NISSAN	PRIMASTAR Van (X83) / dCi 100	74 kW 1870 cc	03.2001-	132121	31
NISSAN	PRIMASTAR Van (X83) / dCi 120	84 kW 1995 cc	09.2006-	132122	32
NISSAN	PRIMASTAR Van (X83) / dCi 140	99 kW 2463 cc	07.2003-	132121	31
NISSAN	PRIMASTAR Van (X83) / dCi 150	107 kW 2464 cc	09.2006-	132122	32
NISSAN	PRIMASTAR Van (X83) / dCi 80	60 kW 1870 cc	03.2001-	132121	31
NISSAN	PULSAR VII Schrägh. (N16) / 1.5 dCi	60 kW 1461 cc	01.2003-	132121	31
NISSAN	PULSAR VII Schrägh. (N16) / 2.2 dCi	100 kW 2184 cc	09.2003-	132121	31
NISSAN	PULSAR VII Schrägh. (N16) / 2.2 dCi	82 kW 2184 cc	09.2003-	132121	31
NISSAN	PULSAR VII Stufenh. (N16) / 1.5 dCi	60 kW 1461 cc	01.2003-	132121	31
NISSAN	PULSAR VII Stufenh. (N16) / 2.2 dCi	100 kW 2184 cc	09.2003-	132121	31
OPEL	ARENA Combi (THB) / 2.5 D	55 kW 2394 cc	03.1998-08.2001	132064	22
OPEL	ARENA Kasten (TB, TF) / 2.5 D	55 kW 2499 cc	03.1998-08.2001	132064	22
OPEL	ASCONA C / 2.0 i GT	95 kW 2299 cc	03.1987-08.1988	132014	16
OPEL	ASCONA C / 2.0 i KAT	85 kW 1998 cc	09.1986-08.1988	132014	16
OPEL	ASCONA C (81_, 86_, 87_, 88_) / 1.6 D	40 kW 1598 cc	03.1982-08.1988	132067	22
OPEL	ASCONA C (81_, 86_, 87_, 88_) / 1.6 D	40 kW 1998 cc	03.1982-08.1988	132060	22
OPEL	ASCONA C (81_, 86_, 87_, 88_) / 1.8 E	74 kW 1769 cc	01.1985-08.1986	132010	15
OPEL	ASCONA C (81_, 86_, 87_, 88_) / 1.8 E	74 kW 1796 cc	01.1985-08.1986	132011	16
OPEL	ASCONA C (81_, 86_, 87_, 88_) / 1.8 i	85 kW 1796 cc	09.1982-08.1986	132011	16



Modell
Model

Motor
Engine



Baujahr
Construction year

HÜCO-NO. Seite
Page

OPEL	ASCONA C (81_, 86_, 87_, 88_) / 1.8 i	85 kW 1998 cc	09.1982-08.1986	132010	15
OPEL	ASCONA C (81_, 86_, 87_, 88_) / 2.0 i	74 kW 1905 cc	08.1987-08.1988	132014	16
OPEL	ASCONA C CC (84_, 89_) / 1.6 D	40 kW 1598 cc	03.1982-08.1988	132067	22
OPEL	ASCONA C CC (84_, 89_) / 1.6 D	40 kW 1868 cc	03.1982-08.1988	132060	22
OPEL	ASCONA C CC (84_, 89_) / 1.8 E	74 kW 1796 cc	01.1985-08.1986	132010	15
OPEL	ASCONA C CC (84_, 89_) / 1.8 E	74 kW 1796 cc	01.1985-08.1986	132011	16
OPEL	ASCONA C CC (84_, 89_) / 1.8 i	85 kW 1527 cc	09.1982-08.1986	132010	15
OPEL	ASCONA C CC (84_, 89_) / 1.8 i	85 kW 1796 cc	09.1982-08.1986	132011	16
OPEL	ASCONA C CC (84_, 89_) / 2.0 i	85 kW 1998 cc	09.1986-08.1988	132014	16
OPEL	ASCONA C CC (84_, 89_) / 2.0 i GT	95 kW 2394 cc	03.1987-08.1988	132014	16
OPEL	ASCONA C CC (84_, 89_) / 2.0 i KAT	85 kW 3453 cc	09.1986-08.1988	132014	16
OPEL	ASTRA F (56_, 57_) / 1.7 D	42 kW 1700 cc	03.1992-09.1992	132060	22
OPEL	ASTRA F (56_, 57_) / 1.7 D	42 kW 1700 cc	03.1992-09.1992	132067	22
OPEL	ASTRA F (56_, 57_) / 1.7 D	44 kW 1975 cc	07.1992-09.1998	132067	22
OPEL	ASTRA F (56_, 57_) / 1.8 i	66 kW 2463 cc	03.1992-09.1998	132014	16
OPEL	ASTRA F (56_, 57_) / 1.8 i 16V	85 kW 1929 cc	11.1994-09.1998	132014	16
OPEL	ASTRA F (56_, 57_) / 1.8 i 16V	92 kW 1461 cc	06.1993-10.1994	132014	16
OPEL	ASTRA F (56_, 57_) / 2.0 i	85 kW 1998 cc	03.1992-09.1998	132014	16
OPEL	ASTRA F (56_, 57_) / 2.0 i 16V	100 kW 2461 cc	02.1995-09.1998	132014	16
OPEL	ASTRA F Cabriolet (53_B) / 1.8 i 16V	85 kW 1968 cc	11.1994-03.2001	132014	16
OPEL	ASTRA F Cabriolet (53_B) / 2.0 i	85 kW 1799 cc	03.1993-10.1994	132014	16
OPEL	ASTRA F Carav. (51_, 52_) / 1.7 D	42 kW 1700 cc	12.1991-09.1992	132067	22
OPEL	ASTRA F Carav. (51_, 52_) / 1.7 D	42 kW 1975 cc	12.1991-09.1992	132060	22
OPEL	ASTRA F Carav. (51_, 52_) / 1.7 D	44 kW 1461 cc	07.1992-01.1998	132067	22
OPEL	ASTRA F Carav. (51_, 52_) / 1.8 i	66 kW 1997 cc	09.1991-01.1998	132014	16
OPEL	ASTRA F Carav. (51_, 52_) / 1.8 i 16V	85 kW 1988 cc	07.1994-01.1998	132014	16
OPEL	ASTRA F Carav. (51_, 52_) / 1.8 i 16V	92 kW 1975 cc	06.1993-01.1998	132014	16
OPEL	ASTRA F Carav. (51_, 52_) / 2.0 i 16V	100 kW 1998 cc	02.1995-01.1998	132014	16
OPEL	ASTRA F Carav. (51_, 52_) / 2.0 i 16V	110 kW 1799 cc	03.1993-01.1998	132014	16
OPEL	ASTRA F CC / 1.7 D	42 kW 1700 cc	12.1991-09.1992	132067	22
OPEL	ASTRA F CC / 1.7 D	42 kW 1997 cc	12.1991-09.1992	132060	22
OPEL	ASTRA F CC / 1.7 D	44 kW 1975 cc	07.1992-01.1998	132067	22
OPEL	ASTRA F CC / 1.8 i	66 kW 1896 cc	09.1991-01.1998	132014	16
OPEL	ASTRA F CC / 1.8 i 16V	85 kW 1799 cc	09.1994-01.1998	132014	16
OPEL	ASTRA F CC / 1.8 i 16V	92 kW 1998 cc	06.1993-08.1994	132014	16
OPEL	ASTRA F CC / 2.0 i	85 kW 2461 cc	09.1991-01.1998	132014	16
OPEL	ASTRA F CC / 2.0 i 16V	100 kW 1998 cc	02.1995-01.1998	132014	16
OPEL	ASTRA F CC / 2.0 GSI 16V	110 kW 1998 cc	09.1991-01.1998	132014	16
OPEL	ASTRA F Van (55_) / 1.7 D	42 kW 1698 cc	12.1991-09.1992	132060	22
OPEL	ASTRA F Van (55_) / 1.7 D	42 kW 1700 cc	12.1991-09.1992	132067	22
OPEL	CALIBRA A (85_) / 2.0 i	85 kW 1896 cc	06.1990-07.1997	132014	16
OPEL	CALIBRA A (85_) / 2.0 i 16V	100 kW 1799 cc	02.1994-07.1997	132014	16
OPEL	CALIBRA A (85_) / 2.0 i 4x4	85 kW 1998 cc	06.1990-07.1997	132014	16
OPEL	CORSA A CC / 1.6 GSI	72 kW 1699 cc	09.1989-03.1993	132014	16
OPEL	CORSA A CC / 1.6 GSI	74 kW 1796 cc	05.1988-03.1992	132014	16
OPEL	CORSA A CC 1.6 GSI KAT	74 kW 1753 cc	02.1992-03.1993	132014	16
OPEL	FRONTERA A (5_MWL4) / 2.4 i (53MWL4)	92 kW 1997 cc	03.1992-10.1998	132014	16
OPEL	FRONTERA A Sport 2.0 i	85 kW 1461 cc	03.1992-10.1998	132014	16
OPEL	KADETT D / 1.8 GT/E	85 kW 1781 cc	02.1983-08.1984	132010	15
OPEL	KADETT D / 1.8 GT/E	85 kW 1796 cc	02.1983-08.1984	132011	16
OPEL	KADETT D (31_-34_, 41_-44_) / 1.6 D	40 kW 1598 cc	03.1982-08.1984	132067	22
OPEL	KADETT D (31_-34_, 41_-44_) / 1.6 D	40 kW 1796 cc	03.1982-08.1984	132060	22
OPEL	KADETT D Carav. / 1.6 D	40 kW 1598 cc	03.1982-08.1984	132067	22
OPEL	KADETT D Carav. / 1.6 D	40 kW 1997 cc	03.1982-08.1984	132060	22
OPEL	KADETT E (39_, 49_) / 1.6 D	40 kW 1998 cc	09.1984-01.1989	132067	22
OPEL	KADETT E (39_, 49_) / 1.6 i	55 kW 1796 cc	09.1986-08.1991	132014	16
OPEL	KADETT E (39_, 49_) / 1.6 i KAT	55 kW 1998 cc	09.1986-08.1991	132014	16
OPEL	KADETT E (39_, 49_) / 1.7 D	42 kW 1598 cc	02.1989-08.1991	132060	22
OPEL	KADETT E (39_, 49_) / 1.7 D	42 kW 1700 cc	02.1989-08.1991	132067	22
OPEL	KADETT E (39_, 49_) / 1.8	84 kW 2497 cc	09.1987-08.1990	132014	16
OPEL	KADETT E (39_, 49_) / 1.8 i	66 kW 1700 cc	09.1990-08.1991	132014	16
OPEL	KADETT E (39_, 49_) / 1.8 i	74 kW 1588 cc	10.1985-08.1986	132010	15
OPEL	KADETT E (39_, 49_) / 1.8 i	74 kW 1796 cc	10.1985-08.1986	132011	16
OPEL	KADETT E (39_, 49_) / 1.8 i	85 kW 1796 cc	09.1984-08.1986	132011	16
OPEL	KADETT E (39_, 49_) / 1.8 i	85 kW 2594 cc	09.1984-08.1986	132010	15
OPEL	KADETT E (39_, 49_) / 2.0 i	85 kW 1796 cc	03.1987-08.1991	132014	16
OPEL	KADETT E (39_, 49_) / 2.0 i KAT	85 kW 1598 cc	03.1987-08.1991	132014	16



Modell
Model

Motor
Engine



Baujahr
Construction year

HÜCO-NO. Seite
Page

OPEL	KADETT E Cabriolet (43B_) / 1.4 i	44 kW 1389 cc	01.1990-08.1991	132011	16
OPEL	KADETT E Cabriolet (43B_) / 1.4 i	44 kW 1781 cc	01.1990-08.1991	132010	15
OPEL	KADETT E Cabriolet (43B_) / 1.6 i	55 kW 1769 cc	10.1986-02.1993	132014	16
OPEL	KADETT E Cabriolet (43B_) / 1.6 i	60 kW 1905 cc	07.1989-02.1993	132014	16
OPEL	KADETT E Cabriolet (43B_) / 1.6 i KAT	55 kW 1998 cc	10.1987-02.1993	132014	16
OPEL	KADETT E Cabriolet (43B_) / 2.0 i	85 kW 1598 cc	10.1986-02.1993	132014	16
OPEL	KADETT E Cabriolet (43B_) / 2.0 i KAT	85 kW 1598 cc	10.1986-02.1993	132014	16
OPEL	KADETT E Carav. / 1.6 D	40 kW 1598 cc	09.1984-01.1989	132067	22
OPEL	KADETT E Carav. / 1.6 D	40 kW 1998 cc	09.1984-01.1989	132060	22
OPEL	KADETT E Carav. / 1.6 i	55 kW 1598 cc	09.1986-08.1991	132014	16
OPEL	KADETT E Carav. / 1.6 i KAT	55 kW 1998 cc	09.1986-08.1991	132014	16
OPEL	KADETT E Carav. / 1.7 D	42 kW 1598 cc	02.1989-08.1991	132060	22
OPEL	KADETT E Carav. / 1.7 D	42 kW 1700 cc	02.1989-08.1991	132067	22
OPEL	KADETT E Carav. / 1.8 E	74 kW 1796 cc	10.1985-08.1986	132011	16
OPEL	KADETT E Carav. / 1.8 E	74 kW 2383 cc	10.1985-08.1986	132010	15
OPEL	KADETT E Carav. / 1.8 i	66 kW 1700 cc	06.1985-08.1991	132010	15
OPEL	KADETT E Carav. / 1.8 i	66 kW 1796 cc	06.1985-08.1991	132011	16
OPEL	KADETT E Carav. / 1.8 i	66 kW 1796 cc	06.1985-08.1991	132014	16
OPEL	KADETT E Carav. / 2.0 i	85 kW 1796 cc	09.1987-08.1991	132014	16
OPEL	KADETT E Carav. / 2.0 i KAT	85 kW 1598 cc	09.1987-08.1991	132014	16
OPEL	KADETT E CC / 1.6 D	40 kW 1598 cc	09.1984-01.1989	132067	22
OPEL	KADETT E CC / 1.6 D	40 kW 1995 cc	09.1984-01.1989	132060	22
OPEL	KADETT E CC / 1.6 i	55 kW 2383 cc	09.1986-08.1991	132014	16
OPEL	KADETT E CC / 1.6 i KAT	55 kW 1598 cc	09.1986-08.1991	132014	16
OPEL	KADETT E CC / 1.8 E	74 kW 1781 cc	10.1985-08.1986	132010	15
OPEL	KADETT E CC / 1.8 GSI	85 kW 1796 cc	09.1984-08.1986	132010	15
OPEL	KADETT E CC / 1.8 GSI	85 kW 1796 cc	09.1984-08.1986	132011	16
OPEL	KADETT E CC / 1.8 i	66 kW 1796 cc	06.1985-08.1991	132011	16
OPEL	KADETT E CC / 1.8 i	66 kW 1796 cc	06.1985-08.1991	132014	16
OPEL	KADETT E CC / 1.8 i	66 kW 2226 cc	06.1985-08.1991	132010	15
OPEL	KADETT E CC / 2.0 GSI	95 kW 2935 cc	09.1986-08.1991	132014	16
OPEL	KADETT E CC / 2.0 GSI 16V KAT	110 kW 1998 cc	03.1988-08.1991	132014	16
OPEL	KADETT E CC / 2.0 GSI KAT	85 kW 1598 cc	09.1986-08.1991	132014	16
OPEL	KADETT E Combo (38_, 48_) / 1.6 D	40 kW 1598 cc	01.1986-12.1989	132067	22
OPEL	KADETT E Combo (38_, 48_) / 1.6 D	40 kW 2383 cc	01.1986-12.1989	132060	22
OPEL	KADETT E Combo (38_, 48_) / 1.6 i	55 kW 1968 cc	08.1991-07.1994	132014	16
OPEL	KADETT E Combo (38_, 48_) / 1.7 D	42 kW 1598 cc	01.1989-07.1994	132060	22
OPEL	KADETT E Kasten (37_, 47_) / 1.6 D	40 kW 1598 cc	08.1984-08.1988	132067	22
OPEL	KADETT E Kasten (37_, 47_) / 1.6 D	40 kW 1753 cc	08.1984-08.1988	132060	22
OPEL	MANTA B (58_, 59_) / 2.0 E	81 kW 1979 cc	08.1977-08.1988	132010	15
OPEL	MANTA B (58_, 59_) / 2.0 E	81 kW 1979 cc	08.1977-08.1988	132011	16
OPEL	MANTA B (58_, 59_) / 2.4 400	106 kW 2410 cc	07.1980-08.1984	132011	16
OPEL	MANTA B (58_, 59_) / 2.4 400	106 kW 2969 cc	07.1980-08.1984	132010	15
OPEL	MANTA B CC (53_, 55_) / 2.0 E	81 kW 1870 cc	08.1977-08.1988	132010	15
OPEL	MANTA B CC (53_, 55_) / 2.0 E	81 kW 1979 cc	08.1977-08.1988	132011	16
OPEL	MONZA A (22_) / 2.5 E	100 kW 2370 cc	05.1981-08.1986	132010	15
OPEL	MONZA A (22_) / 2.5 E	103 kW 2490 cc	06.1984-08.1986	132010	15
OPEL	MONZA A (22_) / 3.0 GSE	115 kW 1870 cc	09.1985-08.1986	132010	15
OPEL	MONZA A (22_) / 3.0 GSE	132 kW 1589 cc	02.1978-08.1986	132010	15
OPEL	MOVANO B Bus / 2.3 CDTI	107 kW 2298 cc (M9T698)	12.2010-	132123	32
OPEL	MOVANO B Bus / 2.3 CDTI	74 kW 2298 cc (M9T670)	12.2010-	132123	32
OPEL	MOVANO B Bus / 2.3 CDTI	92 kW 2298 cc (M9T670)	12.2010-	132123	32
OPEL	MOVANO B Kasten / 2.3 CDTI [RWD]	107 kW 2298 cc (M9T698)	05.2010-	132123	32
OPEL	MOVANO B Kasten / 2.3 CDTI [RWD]	74 kW 2298 cc (M9T670)	05.2010-	132123	32
OPEL	MOVANO B Kasten / 2.3 CDTI [RWD]	92 kW 2298 cc (M9T670)	05.2010-	132123	32
OPEL	MOVANO B Kasten / 2.3 CDTI FWD	107 kW 2298 cc (M9T698)	05.2010-	132123	32
OPEL	MOVANO B Kasten / 2.3 CDTI FWD	74 kW 2298 cc (M9T670)	05.2010-	132123	32
OPEL	MOVANO B Kasten / 2.3 CDTI FWD	92 kW 2298 cc (M9T670)	05.2010-	132123	32
OPEL	MOVANO B Pritsche / 2.3 CDTI [RWD]	107 kW 2298 cc (M9T698)	05.2010-	132123	32
OPEL	MOVANO B Pritsche / 2.3 CDTI [RWD]	74 kW 2298 cc (M9T670)	05.2010-	132123	32
OPEL	MOVANO B Pritsche / 2.3 CDTI [RWD]	92 kW 2298 cc (M9T670)	05.2010-	132123	32
OPEL	MOVANO B Pritsche / 2.3 CDTI FWD	107 kW 2298 cc (M9T698)	05.2010-	132123	32
OPEL	MOVANO B Pritsche / 2.3 CDTI FWD	74 kW 2298 cc (M9T670)	05.2010-	132123	32
OPEL	MOVANO B Pritsche / 2.3 CDTI FWD	92 kW 2298 cc (M9T670)	05.2010-	132123	32
OPEL	MOVANO Combi (J9) / 1.9 DTI	59 kW 1870 cc	09.2000-10.2001	132121	31
OPEL	MOVANO Combi (J9) / 1.9 DTI	59 kW 1870 cc (F9Q770)	09.2000-10.2001	132074	31
OPEL	MOVANO Combi (J9) / 1.9 DTI	60 kW 1868 cc	10.2001-	132121	31



Modell
Model

Motor
Engine



Baujahr
Construction year

HÜCO-NO. Seite
Page

	Modell Model	Motor Engine	Baujahr Construction year	HÜCO-NO.	Seite Page
OPEL	MOVANO Combi (J9) / 2.2 DTI	66 kW 2188 cc (G9T720)	09.2000-	132121	31
OPEL	MOVANO Combi (J9) / 2.5 CDTI	107 kW 2464 cc (G9U650)	08.2006-	132122	32
OPEL	MOVANO Combi (J9) / 2.5 CDTI	74 kW 2464 cc (G9U650)	09.2007-	132122	32
OPEL	MOVANO Combi (J9) / 2.5 CDTI	88 kW 2464 cc (G9U632)	08.2006-	132122	32
OPEL	MOVANO Combi (J9) / 2.5 D	59 kW 1998 cc	07.1998-09.2000	132064	22
OPEL	MOVANO Combi (J9) / 2.5 DTI	84 kW 1870 cc	10.2001-	132121	31
OPEL	MOVANO Combi (J9) / 3.0 DTi	100 kW 2953 cc (ZD3200)	10.2003-	132121	31
OPEL	MOVANO Kasten (F9) / 1.9 DTI	59 kW 1870 cc	09.2000-10.2001	132121	31
OPEL	MOVANO Kasten (F9) / 1.9 DTI	59 kW 1870 cc (F9Q770)	09.2000-10.2001	132074	31
OPEL	MOVANO Kasten (F9) / 1.9 DTI	60 kW 1870 cc	10.2001-	132121	31
OPEL	MOVANO Kasten (F9) / 2.2 DTI	66 kW 2188 cc (G9T722)	09.2000-	132121	31
OPEL	MOVANO Kasten (F9) / 2.5 CDTI	107 kW 2464 cc (G9U632)	08.2006-	132122	32
OPEL	MOVANO Kasten (F9) / 2.5 CDTI	74 kW 2464 cc (G9U650)	08.2006-	132122	32
OPEL	MOVANO Kasten (F9) / 2.5 CDTI	88 kW 2464 cc (G9U632)	08.2006-	132122	32
OPEL	MOVANO Kasten (F9) / 2.5 D	59 kW 2499 cc	01.1999-09.2000	132064	22
OPEL	MOVANO Kasten (F9) / 2.5 DTi	73 kW 2463 cc	10.2003-	132122	32
OPEL	MOVANO Kasten (F9) / 2.5 DTi	73 kW 2463 cc (G9U754)	10.2003-	132121	31
OPEL	MOVANO Kasten (F9) / 2.5 DTI	84 kW 2463 cc	10.2001-	132122	32
OPEL	MOVANO Kasten (F9) / 2.5 DTI	84 kW 2463 cc (G9U754)	10.2001-	132121	31
OPEL	MOVANO Kasten (F9) / 3.0 DTI	100 kW 2953 cc (ZD3200)	10.2003-	132121	31
OPEL	MOVANO Kipper (H9) / 2.2 DTI	66 kW 2188 cc (G9T722)	09.2000-	132121	31
OPEL	MOVANO Kipper (H9) / 2.5 CDTI	107 kW 2464 cc (G9U650)	08.2006-	132122	32
OPEL	MOVANO Kipper (H9) / 2.5 CDTI	74 kW 2464 cc (G9U650)	08.2006-	132122	32
OPEL	MOVANO Kipper (H9) / 2.5 D	59 kW 2383 cc	01.1999-09.2000	132064	22
OPEL	MOVANO Kipper (H9) / 2.5 DTI	73 kW 2463 cc	10.2003-	132122	32
OPEL	MOVANO Kipper (H9) / 2.5 DTI	73 kW 2463 cc (G9U754)	10.2003-	132121	31
OPEL	MOVANO Kipper (H9) / 2.5 DTI	84 kW 2463 cc (G9U754)	10.2001-	132122	32
OPEL	MOVANO Pritsche (U9, E9) / 2.2 DTI	66 kW 2188 cc (G9T722)	09.2000-	132121	31
OPEL	MOVANO Pritsche (U9, E9) / 2.5 CDTI	107 kW 2464 cc (G9U632)	08.2006-	132122	32
OPEL	MOVANO Pritsche (U9, E9) / 2.5 CDTI	74 kW 2464 cc (G9U650)	08.2006-	132122	32
OPEL	MOVANO Pritsche (U9, E9) / 2.5 CDTI	88 kW 2464 cc (G9U650)	08.2006-	132122	32
OPEL	MOVANO Pritsche (U9, E9) / 2.5 D	59 kW 2499 cc	07.1998-09.2000	132064	22
OPEL	MOVANO Pritsche (U9, E9) / 2.5 DTi	73 kW 2463 cc (G9U754)	10.2003-	132122	32
OPEL	MOVANO Pritsche (U9, E9) / 2.5 DTI	84 kW 2463 cc	10.2001-	132122	32
OPEL	MOVANO Pritsche (U9, E9) / 2.5 DTI	84 kW 2463 cc (G9U754)	10.2001-	132121	31
OPEL	MOVANO Pritsche (U9, E9) / 3.0 DTI	100 kW 2953 cc (ZD3200)	10.2003-	132121	31
OPEL	OMEGA A / 3.6 24V Lotus	277 kW 1422 cc	08.1990-09.1992	132014	16
OPEL	OMEGA A 3.0 24V Evolution500	169 kW 1870 cc	03.1991-07.1992	132014	16
OPEL	OMEGA A (16_, 17_, 19_) / 1.8	65 kW 1796 cc	09.1987-03.1994	132014	16
OPEL	OMEGA A (16_, 17_, 19_) / 1.8	85 kW 2068 cc	09.1986-03.1994	132014	16
OPEL	OMEGA A (16_, 17_, 19_) / 1.8 N	60 kW 1968 cc	09.1986-08.1987	132014	16
OPEL	OMEGA A (16_, 17_, 19_) / 1.8 S	66 kW 1796 cc	09.1986-03.1994	132014	16
OPEL	OMEGA A (16_, 17_, 19_) / 2.0	73 kW 1998 cc	09.1990-03.1994	132014	16
OPEL	OMEGA A (16_, 17_, 19_) / 2.0	74 kW 2260 cc	09.1990-03.1994	132014	16
OPEL	OMEGA A (16_, 17_, 19_) / 2.0	90 kW 1796 cc	09.1986-03.1994	132014	16
OPEL	OMEGA A (16_, 17_, 19_) / 2.0 i	85 kW 2068 cc	09.1986-03.1994	132014	16
OPEL	OMEGA A (16_, 17_, 19_) / 2.3 D	54 kW 2969 cc	10.1986-03.1994	132060	22
OPEL	OMEGA A (16_, 17_, 19_) / 2.3 TD Interc.	74 kW 2260 cc	08.1988-03.1994	132060	22
OPEL	OMEGA A (16_, 17_, 19_) / 2.4 i	92 kW 1998 cc	09.1988-03.1994	132014	16
OPEL	OMEGA A (16_, 17_, 19_) / 2.6 i	110 kW 2410 cc	09.1990-03.1994	132014	16
OPEL	OMEGA A (16_, 17_, 19_) / 3.0 (3000)	115 kW 1997 cc	03.1987-12.1987	132014	16
OPEL	OMEGA A (16_, 17_, 19_) / 3.0 24V	147 kW 1796 cc	09.1989-03.1994	132014	16
OPEL	OMEGA A (16_, 17_, 19_) / 3.0 24V	150 kW 2969 cc	09.1989-03.1994	132014	16
OPEL	OMEGA A (16_, 17_, 19_) / 3.0 KAT	130 kW 1998 cc	03.1988-03.1994	132014	16
OPEL	OMEGA A Carav. 2.3 TD Interc.	74 kW 1753 cc	09.1988-03.1994	132060	22
OPEL	OMEGA A Carav. (66_, 67_) / 1.8	65 kW 1796 cc	09.1987-03.1994	132014	16
OPEL	OMEGA A Carav. (66_, 67_) / 1.8	85 kW 1796 cc	09.1986-03.1994	132014	16
OPEL	OMEGA A Carav. (66_, 67_) / 1.8 N	60 kW 2969 cc	09.1986-08.1987	132014	16
OPEL	OMEGA A Carav. (66_, 67_) / 1.8 S	66 kW 1796 cc	09.1986-03.1994	132014	16
OPEL	OMEGA A Carav. (66_, 67_) / 2.0	74 kW 2260 cc	09.1990-03.1994	132014	16
OPEL	OMEGA A Carav. (66_, 67_) / 2.0	90 kW 1870 cc	09.1986-03.1994	132014	16
OPEL	OMEGA A Carav. (66_, 67_) / 2.0 i	73 kW 1998 cc	09.1990-03.1994	132014	16
OPEL	OMEGA A Carav. (66_, 67_) / 2.0 i	85 kW 1998 cc	09.1986-03.1994	132014	16
OPEL	OMEGA A Carav. (66_, 67_) / 2.3 D	54 kW 1998 cc	09.1986-03.1994	132060	22
OPEL	OMEGA A Carav. (66_, 67_) / 2.4 i	92 kW 1998 cc	09.1988-03.1994	132014	16
OPEL	OMEGA A Carav. (66_, 67_) / 2.6 i	110 kW 1769 cc	09.1990-03.1994	132014	16
OPEL	OMEGA A Carav. (66_, 67_) / 3.0	115 kW 2299 cc	03.1987-03.1994	132014	16



Modell
Model

Motor
Engine



Baujahr
Construction year

HÜCO-NO. Seite
Page

	Modell Model	Motor Engine	Baujahr Construction year	HÜCO-NO.	Seite Page
OPEL	OMEGA A Carav. (66_, 67_) / 3.0	130 kW 1698 cc	03.1987-09.1990	132014	16
OPEL	OMEGA A Carav. (66_, 67_) / 3.0 24V	147 kW 2969 cc	09.1989-03.1994	132014	16
OPEL	OMEGA A Carav. (66_, 67_) / 3.0 KAT	130 kW 2594 cc	03.1987-03.1994	132014	16
OPEL	REKORD E / 1.8 E	74 kW 1796 cc	05.1985-08.1986	132011	16
OPEL	REKORD E / 1.8 E	74 kW 1868 cc	05.1985-08.1986	132010	15
OPEL	REKORD E / 2.0 E	81 kW 1598 cc	09.1977-10.1984	132010	15
OPEL	REKORD E / 2.0 E	81 kW 1979 cc	09.1977-10.1984	132011	16
OPEL	REKORD E / 2.2 E	85 kW 1698 cc	11.1984-08.1986	132010	15
OPEL	REKORD E / 2.2 E	85 kW 2197 cc	11.1984-08.1986	132011	16
OPEL	REKORD E / 2.2 TD	63 kW 1905 cc	06.1984-08.1986	132060	22
OPEL	REKORD E Carav. / 1.8 E	74 kW 1796 cc	05.1985-08.1986	132011	16
OPEL	REKORD E Carav. / 1.8 E	74 kW 1997 cc	05.1985-08.1986	132010	15
OPEL	REKORD E Carav. / 2.0 E	81 kW 1779 cc	09.1977-10.1984	132010	15
OPEL	REKORD E Carav. / 2.0 E	81 kW 1979 cc	09.1977-10.1984	132011	16
OPEL	REKORD E Carav. / 2.2 E	85 kW 1979 cc	11.1984-08.1986	132010	15
OPEL	REKORD E Carav. / 2.2 E	85 kW 2197 cc	11.1984-08.1986	132011	16
OPEL	REKORD E Carav. / 2.2 TD	63 kW 2197 cc	06.1984-08.1986	132060	22
OPEL	SENATOR A (29_) / 2.2 TD	63 kW 2969 cc	11.1984-08.1987	132060	22
OPEL	SENATOR A (29_) / 2.5 E	100 kW 2490 cc	01.1983-08.1984	132011	16
OPEL	SENATOR A (29_) / 2.5 E	100 kW 2969 cc	01.1983-08.1984	132010	15
OPEL	SENATOR A (29_) / 2.5 E	103 kW 2490 cc	09.1984-08.1987	132010	15
OPEL	SENATOR A (29_) / 2.5 E	103 kW 2490 cc	09.1984-08.1987	132011	16
OPEL	SENATOR A (29_) / 3.0 E	132 kW 2490 cc	02.1978-12.1986	132010	15
OPEL	SENATOR A (29_) / 3.0 E	132 kW 2969 cc	02.1978-12.1986	132011	16
OPEL	VECTRA A (86_, 87_) / 1.7 D	42 kW 2088 cc	10.1988-09.1992	132060	22
OPEL	VECTRA A (86_, 87_) / 2.0 i	85 kW 1997 cc	09.1988-10.1990	132014	16
OPEL	VECTRA A (86_, 87_) / 2.0 i	95 kW 1998 cc	09.1988-09.1992	132014	16
OPEL	VECTRA A (86_, 87_) / 2.0 i 16V	100 kW 1799 cc	06.1994-11.1995	132014	16
OPEL	VECTRA A (86_, 87_) / 2.0 i 16V 4x4	100 kW 1998 cc	06.1994-11.1995	132014	16
OPEL	VECTRA A (86_, 87_) / 2.0 i 4x4	85 kW 2792 cc	01.1989-10.1990	132014	16
OPEL	VECTRA A (86_, 87_) / 2.0 i 4x4	95 kW 1998 cc	01.1989-09.1992	132014	16
OPEL	VECTRA A (86_, 87_) / 2.0 i 4x4 KAT	85 kW 1998 cc	01.1989-11.1995	132014	16
OPEL	VECTRA A (86_, 87_) / 2.0 i KAT	85 kW 2969 cc	09.1988-11.1995	132014	16
OPEL	VECTRA A (86_, 87_) / 2.0 i Turbo 4x4	150 kW 2151 cc	06.1994-11.1995	132014	16
OPEL	VECTRA A (86_, 87_) / 2000 16V 4x4	110 kW 1595 cc	01.1989-10.1990	132014	16
OPEL	VECTRA A (86_, 87_) / 2000/GT 16V	110 kW 1700 cc	01.1989-06.1994	132014	16
OPEL	VECTRA A (86_, 87_) / 2000/GT 16V KAT	110 kW 1998 cc	02.1990-11.1995	132014	16
OPEL	VECTRA A / 2000/GT 16V 4x4 KAT	110 kW 1998 cc	02.1990-11.1995	132014	16
OPEL	VECTRA A CC / 2.0 i 16V KAT	110 kW 1998 cc	02.1990-11.1995	132014	16
OPEL	VECTRA A CC (88_, 89_) / 1.7 D	42 kW 2463 cc	09.1988-09.1992	132060	22
OPEL	VECTRA A CC (88_, 89_) / 2.0 i	85 kW cc	09.1988-10.1990	132014	16
OPEL	VECTRA A CC (88_, 89_) / 2.0 i 16V	100 kW 1998 cc	06.1994-11.1995	132014	16
OPEL	VECTRA A CC (88_, 89_) / 2.0 i 16V	110 kW 1998 cc	02.1989-10.1990	132014	16
OPEL	VECTRA A CC (88_, 89_) / 2.0 i GT	95 kW 1998 cc	09.1988-11.1995	132014	16
OPEL	VECTRA A CC (88_, 89_) / 2.0 i KAT	85 kW 1998 cc	09.1988-11.1995	132014	16
OPEL	VIVARO Combi (J7) / 1.9 DI	60 kW 1896 cc	08.2001-	132121	31
OPEL	VIVARO Combi (J7) / 1.9 DTI	74 kW 1870 cc (F9Q760)	08.2001-	132121	31
OPEL	VIVARO Combi (J7) / 2.0 CDTI	84 kW 1997 cc	08.2006-	132122	32
OPEL	VIVARO Combi (J7) / 2.5 DTI	99 kW 1975 cc	05.2003-	132121	31
OPEL	VIVARO Kasten (F7) / 1.9 DI	60 kW 1870 cc (F9Q762)	08.2001-	132121	31
OPEL	VIVARO Kasten (F7) / 1.9 DTI	74 kW 1870 cc (F9Q760)	08.2001-	132121	31
OPEL	VIVARO Kasten (F7) / 2.5 DTI	99 kW 2463 cc	05.2003-	132121	31
OPEL	VIVARO Pritsche (E7) / 1.9 DTI	74 kW 1870 cc (F9Q760)	08.2006-	132121	31
OPEL	VIVARO Pritsche (E7) / 2.0 CDTI	84 kW 1968 cc	08.2006-	132122	32
PEUGEOT	106 (1A, 1C) / 1.4 D	37 kW 1361 cc (K9Y(TUD3Y))	09.1992-04.1996	132080	29
PEUGEOT	106 (1A, 1C) / 1.5 D	40 kW 2446 cc	06.1994-04.1996	132085	30
PEUGEOT	106 (1A, 1C) / 1.5 D	43 kW 1796 cc	06.1994-04.1996	132085	30
PEUGEOT	106 I (1A, 1C) / 1.4 D	37 kW 1361 cc	09.1992-04.1996	132080	29
PEUGEOT	106 I (1A, 1C) / 1.5 D	40 kW 1527 cc	06.1994-04.1996	132085	30
PEUGEOT	106 I (1A, 1C) / 1.5 D	43 kW 1527 cc	06.1994-04.1996	132085	30
PEUGEOT	106 II (1) / 1.5 D	40 kW 2088 cc	05.1996-	132085	30
PEUGEOT	106 II (1) / 1.5 D	42 kW 1527 cc (VJX(TUD5))	10.2000-	132088	25
PEUGEOT	106 Mk II (1) / 1.5 D	40 kW 1527 cc	05.1996-	132085	30
PEUGEOT	106 Mk II (1) / 1.5 D	42 kW 1527 cc	10.2000-	132088	25
PEUGEOT	205 (741A/C) / 1.6 GTI	76 kW 1580 cc	12.1984-10.1987	132040	18
PEUGEOT	205 (741A/C) / 1.7 D	44 kW 1769 cc	08.1983-10.1987	132052	27
PEUGEOT	205 (741A/C) / 1.7 D	44 kW 1769 cc	08.1983-10.1987	132080	29

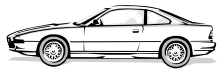

	Modell Model	Motor Engine	Baujahr Construction year	HÜCO-NO.	Seite Page
PEUGEOT	205 (741A/C) / 1.7 D	44 kW 1769 cc (161A(XUD7))	08.1983-10.1987	132051	26
PEUGEOT	205 (741A/C) / 1.9 GTI	75 kW 1753 cc	03.1987-10.1987	132040	18
PEUGEOT	205 (741A/C) / 1.9 GTI	94 kW 1580 cc	10.1986-10.1987	132040	18
PEUGEOT	205 Cabriolet (741B, 20D) / 1.6 CTI	76 kW 2464 cc	04.1986-10.1990	132040	18
PEUGEOT	205 Cabriolet (741B, 20D) / 1.9 CTI	75 kW 1896 cc	10.1987-12.1994	132040	18
PEUGEOT	205 I (741A/C) / 1.6 GTI	76 kW 1580 cc	12.1984-10.1987	132040	18
PEUGEOT	205 I (741A/C) / 1.7 D	44 kW 1769 cc	08.1983-10.1987	132051	26
PEUGEOT	205 I (741A/C) / 1.7 D	44 kW 1769 cc	08.1983-10.1987	132052	27
PEUGEOT	205 I (741A/C) / 1.7 D	44 kW 1769 cc	08.1983-10.1987	132080	29
PEUGEOT	205 I (741A/C) / 1.9 GTI	75 kW 1905 cc	03.1987-10.1987	132040	18
PEUGEOT	205 I (741A/C) / 1.9 GTI	94 kW 1905 cc	10.1986-10.1987	132040	18
PEUGEOT	205 I Cabriolet (741B, 20D) / 1.6 CTI	76 kW 1580 cc	04.1986-10.1990	132040	18
PEUGEOT	205 I Cabriolet (741B, 20D) / 1.9 CTI	75 kW 1905 cc	10.1987-12.1994	132040	18
PEUGEOT	205 II (20A/C) / 1.6 GTI	76 kW 1580 cc	10.1987-12.1989	132040	18
PEUGEOT	205 II (20A/C) / 1.6 GTI	85 kW 1527 cc	10.1987-12.1989	132040	18
PEUGEOT	205 II (20A/C) / 1.7 D	44 kW 1769 cc	07.1987-09.1998	132052	27
PEUGEOT	205 II (20A/C) / 1.7 D	44 kW 1769 cc	07.1987-09.1998	132080	29
PEUGEOT	205 II (20A/C) / 1.7 D	44 kW 1769 cc (161A(XUD7))	07.1987-09.1998	132051	26
PEUGEOT	205 II (20A/C) / 1.7 TD	57 kW 1769 cc	01.1990-09.1998	132052	27
PEUGEOT	205 II (20A/C) / 1.7 TD	57 kW 1905 cc	01.1990-09.1998	132051	26
PEUGEOT	205 II (20A/C) / 1.9 D	47 kW 1905 cc	10.1987-09.1998	132052	27
PEUGEOT	205 II (20A/C) / 1.9 D	47 kW 1905 cc	10.1987-09.1998	132080	29
PEUGEOT	205 II (20A/C) / 1.9 D	47 kW 1905 cc (DJZ(XUD9Y))	10.1987-09.1998	132051	26
PEUGEOT	205 II (20A/C) / 1.9 D	51 kW 1905 cc	08.1987-06.1994	132083	29
PEUGEOT	205 II (20A/C) / 1.9 D	51 kW 1905 cc (XUD9)	08.1987-06.1994	132080	29
PEUGEOT	205 II (20A/C) / 1.9 GTI	75 kW 1896 cc	10.1987-05.1989	132040	18
PEUGEOT	205 II (20A/C) / 1.9 GTI	88 kW 1896 cc	10.1987-10.1994	132040	18
PEUGEOT	205 II (20A/C) / 1.9 GTI	94 kW 1905 cc	10.1987-09.1998	132040	18
PEUGEOT	205 II (20A/C) / 1.9 GTI KAT	75 kW 1968 cc	10.1987-07.1994	132040	18
PEUGEOT	205 Kasten / 1.7 D	44 kW 1769 cc (161A(XUD7))	03.1994-	132080	29
PEUGEOT	205 Mk II (20A/C) / 1.6 GTI	76 kW 1580 cc	10.1987-12.1989	132040	18
PEUGEOT	205 Mk II (20A/C) / 1.6 GTI	85 kW 1580 cc	10.1987-12.1989	132040	18
PEUGEOT	205 Mk II (20A/C) / 1.7 D	44 kW 1769 cc	07.1987-09.1998	132051	26
PEUGEOT	205 Mk II (20A/C) / 1.7 D	44 kW 1769 cc	07.1987-09.1998	132052	27
PEUGEOT	205 Mk II (20A/C) / 1.7 D	44 kW 1769 cc	07.1987-09.1998	132080	29
PEUGEOT	205 Mk II (20A/C) / 1.7 TD	57 kW 1769 cc	01.1990-09.1998	132051	26
PEUGEOT	205 Mk II (20A/C) / 1.7 TD	57 kW 1769 cc	01.1990-09.1998	132052	27
PEUGEOT	205 Mk II (20A/C) / 1.9 D	47 kW 1905 cc	10.1987-09.1998	132051	26
PEUGEOT	205 Mk II (20A/C) / 1.9 D	47 kW 1905 cc	10.1987-09.1998	132052	27
PEUGEOT	205 Mk II (20A/C) / 1.9 D	47 kW 1905 cc	10.1987-09.1998	132080	29
PEUGEOT	205 Mk II (20A/C) / 1.9 D	51 kW 1905 cc	08.1987-06.1994	132080	29
PEUGEOT	205 Mk II (20A/C) / 1.9 D	51 kW 1905 cc	08.1987-06.1994	132083	29
PEUGEOT	205 Mk II (20A/C) / 1.9 GTI	75 kW 1905 cc	10.1987-05.1989	132040	18
PEUGEOT	205 Mk II (20A/C) / 1.9 GTI	88 kW 1905 cc	10.1987-10.1994	132040	18
PEUGEOT	205 Mk II (20A/C) / 1.9 GTI	94 kW 1905 cc	10.1987-09.1998	132040	18
PEUGEOT	205 Mk II (20A/C) / 1.9 GTI KAT	75 kW 1905 cc	10.1987-07.1994	132040	18
PEUGEOT	206 Schrägh. (2A/C) / 1.9 D	51 kW 1868 cc	09.1998-11.2001	132085	30
PEUGEOT	206 Schrägh. (2A/C) / 1.9 D	51 kW 1868 cc (WJZ(DW8))	09.1998-11.2001	132088	25
PEUGEOT	206 Schrägh. (2A/C) / 2.0 HDI 90	66 kW 1997 cc (RHY(DW10TD))	12.1999-	132088	25
PEUGEOT	206 SW (2E/K) / 2.0 HDi	66 kW 1997 cc (RHY(DW10TD))	07.2002-	132088	25
PEUGEOT	304 (_04M_) / 1.4 D (M20)	33 kW 1905 cc	10.1976-10.1979	132050	26
PEUGEOT	304 Break (_04D_) / 1.4 D	33 kW 1995 cc	10.1976-10.1979	132050	26
PEUGEOT	305 (581A) / 1.5 D	36 kW 1548 cc	11.1977-09.1982	132051	26
PEUGEOT	305 (581A) / 1.5 D	36 kW 1548 cc	11.1977-09.1982	132052	27
PEUGEOT	305 (581A) / 1.5 D	36 kW 1975 cc	11.1977-09.1982	132050	26
PEUGEOT	305 I (581A) / 1.5 D	36 kW 1548 cc	11.1977-09.1982	132050	26
PEUGEOT	305 I (581A) / 1.5 D	36 kW 1548 cc	11.1977-09.1982	132051	26
PEUGEOT	305 I (581A) / 1.5 D	36 kW 1548 cc	11.1977-09.1982	132052	27
PEUGEOT	305 I Break (581D) / 1.5 D	36 kW 1548 cc	08.1980-09.1982	132051	26
PEUGEOT	305 I Break (581D) / 1.5 D	36 kW 2464 cc	08.1980-09.1982	132050	26
PEUGEOT	305 II (581M) / 1.9 D	47 kW 1997 cc	10.1982-07.1988	132052	27
PEUGEOT	305 II (581M) / 1.9 D	48 kW 1461 cc	10.1982-07.1988	132052	27
PEUGEOT	305 II Break (581E) / 1.9 D	47 kW 1905 cc	10.1982-12.1988	132052	27
PEUGEOT	305 II Break (581E) / 1.9 D	47 kW 3980 cc	10.1982-12.1988	132051	26
PEUGEOT	305 II Break (581E) / 1.9 D	48 kW 1905 cc	10.1982-12.1988	132051	26
PEUGEOT	305 II Break (581E) / 1.9 D	48 kW 1905 cc	10.1982-12.1988	132052	27
PEUGEOT	305 Kombi (581D) / 1.5 D	36 kW 1548 cc	08.1980-09.1982	132050	26



	Modell Model	Motor Engine	Baujahr Construction year	HÜCO-NO.	Seite Page
PEUGEOT	305 Kombi (581D) / 1.5 D	36 kW 1548 cc	08.1980-09.1982	132051	26
PEUGEOT	305 Mk II (581M) / 1.9 D	47 kW 1905 cc	10.1982-07.1988	132052	27
PEUGEOT	305 Mk II (581M) / 1.9 D	48 kW 1905 cc	10.1982-07.1988	132052	27
PEUGEOT	305 Mk II Kombi (581E) / 1.9 D	47 kW 1905 cc	10.1982-12.1988	132051	26
PEUGEOT	305 Mk II Kombi (581E) / 1.9 D	47 kW 1905 cc	10.1982-12.1988	132052	27
PEUGEOT	305 Mk II Kombi (581E) / 1.9 D	48 kW 1905 cc	10.1982-12.1988	132051	26
PEUGEOT	305 Mk II Kombi (581E) / 1.9 D	48 kW 1905 cc	10.1982-12.1988	132052	27
PEUGEOT	306 (7B, N3, N5) / 1.9 D	51 kW 1868 cc (WJY(DW8B))	09.1998-05.2001	132088	25
PEUGEOT	306 (7B, N3, N5) / 1.9 D	69 kW 1905 cc (XUD9TE)	02.1994-04.1997	132081	28
PEUGEOT	306 (7B, N3, N5) / 1.9 SLD	47 kW 1905 cc	06.1994-05.2001	132085	30
PEUGEOT	306 (7B, N3, N5) / 1.9 SLD	47 kW 1905 cc (DJZ(XUD9Y))	06.1994-05.2001	132080	29
PEUGEOT	306 (7B, N3, N5) / 1.9 SLD	50 kW 1905 cc	06.1994-05.2001	132085	30
PEUGEOT	306 (7B, N3, N5) / 1.9 SLD	50 kW 1905 cc (DJY(XUD9A))	06.1994-05.2001	132080	29
PEUGEOT	306 (7B, N3, N5) / 1.9 SRDT	66 kW 1905 cc (XUD9TE)	06.1994-05.2001	132081	28
PEUGEOT	306 (7B, N3, N5) / 1.9 STD	51 kW 1905 cc	02.1994-10.1995	132083	29
PEUGEOT	306 (7B, N3, N5) / 1.9 STD	51 kW 1905 cc (XUD9)	02.1994-10.1995	132080	29
PEUGEOT	306 (7B, N3, N5) / 2.0 HDI 90	66 kW 1997 cc (RHY(DW10TD))	06.1999-05.2001	132088	25
PEUGEOT	306 Break (7E, N3, N5) / 1.9 D	50 kW 1905 cc	03.1997-04.2002	132085	30
PEUGEOT	306 Break (7E, N3, N5) / 1.9 D	50 kW 1905 cc (DJY(XUD9A))	03.1997-04.2002	132080	29
PEUGEOT	306 Break (7E, N3, N5) / 1.9 D	51 kW 1868 cc (WJY(DW8B))	09.1998-04.2002	132088	25
PEUGEOT	306 Break (7E, N3, N5) / 1.9 D	51 kW 1905 cc (DJY(XUD9A))	05.1997-05.1999	132080	29
PEUGEOT	306 Break (7E, N3, N5) / 1.9 TD	66 kW 1905 cc (XUD9TE)	02.1997-04.2002	132081	28
PEUGEOT	306 Break (7E, N3, N5) / 2.0 HDI 90	66 kW 1997 cc (RHY(DW10TD))	06.1999-04.2002	132088	25
PEUGEOT	306 Schrägh. 2.0 HDI 90	66 kW 1997 cc (RHY(DW10TD))	06.1999-05.2001	132088	25
PEUGEOT	306 Schrägh. (7A, 7C, N3, N5) / 1.8 D	43 kW 1769 cc	05.1993-05.2001	132083	29
PEUGEOT	306 Schrägh. (7A, 7C, N3, N5) / 1.8 D	43 kW 1769 cc (XUD7)	05.1993-05.2001	132080	29
PEUGEOT	306 Schrägh. (7A, 7C, N3, N5) / 1.8 D	44 kW 1769 cc	04.1993-05.1999	132080	29
PEUGEOT	306 Schrägh. (7A, 7C, N3, N5) / 1.9 D	47 kW 1905 cc	05.1993-05.2001	132085	30
PEUGEOT	306 Schrägh. (7A, 7C, N3, N5) / 1.9 D	47 kW 1905 cc (DJZ(XUD9Y))	05.1993-05.2001	132080	29
PEUGEOT	306 Schrägh. (7A, 7C, N3, N5) / 1.9 D	50 kW 1905 cc	06.1994-05.2001	132085	30
PEUGEOT	306 Schrägh. (7A, 7C, N3, N5) / 1.9 D	50 kW 1905 cc (DJY(XUD9A))	06.1994-05.2001	132080	29
PEUGEOT	306 Schrägh. (7A, 7C, N3, N5) / 1.9 D	51 kW 1868 cc (WJY(DW8B))	09.1998-05.2001	132088	25
PEUGEOT	306 Schrägh. (7A, 7C, N3, N5) / 1.9 D	51 kW 1905 cc	04.1993-05.1999	132083	29
PEUGEOT	306 Schrägh. (7A, 7C, N3, N5) / 1.9 D	51 kW 1905 cc (XUD9)	04.1993-05.1999	132080	29
PEUGEOT	306 Schrägh. (7A, 7C, N3, N5) / 1.9 D	69 kW 1905 cc (XUD9TE)	04.1993-04.1997	132081	28
PEUGEOT	306 Schrägh. (7A, 7C, N3, N5) / 1.9 DT	66 kW 1905 cc (XUD9TE)	05.1993-05.2001	132081	28
PEUGEOT	306 Stufenh. (7B, N3, N5) / 1.9 D	51 kW 1868 cc	09.1998-05.2001	132088	25
PEUGEOT	306 Stufenh. (7B, N3, N5) / 1.9 D	69 kW 1905 cc	02.1994-04.1997	132081	28
PEUGEOT	306 Stufenh. (7B, N3, N5) / 1.9 SLD	47 kW 1905 cc	06.1994-05.2001	132080	29
PEUGEOT	306 Stufenh. (7B, N3, N5) / 1.9 SLD	47 kW 1905 cc	06.1994-05.2001	132085	30
PEUGEOT	306 Stufenh. (7B, N3, N5) / 1.9 SLD	50 kW 1905 cc	06.1994-05.2001	132080	29
PEUGEOT	306 Stufenh. (7B, N3, N5) / 1.9 SLD	50 kW 1905 cc	06.1994-05.2001	132085	30
PEUGEOT	306 Stufenh. (7B, N3, N5) / 1.9 SRDT	66 kW 1905 cc	06.1994-05.2001	132081	28
PEUGEOT	306 Stufenh. (7B, N3, N5) / 1.9 STD	51 kW 1905 cc	02.1994-10.1995	132080	29
PEUGEOT	306 Stufenh. (7B, N3, N5) / 1.9 STD	51 kW 1905 cc	02.1994-10.1995	132083	29
PEUGEOT	306 Stufenh. (7B, N3, N5) / 2.0 HDI 90	66 kW 1997 cc	06.1999-05.2001	132088	25
PEUGEOT	307 (3A/C) / 2.0 HDi 110	79 kW 1997 cc (RHS(DW10ATED))	08.2000-	132088	25
PEUGEOT	307 (3A/C) / 2.0 HDi 135	100 kW 1997 cc (RHR(DW10BTED4))	10.2003-	132088	25
PEUGEOT	307 (3A/C) / 2.0 HDi 90	66 kW 1997 cc (RHY(DW10TD))	08.2000-	132088	25
PEUGEOT	307 Break (3E) / 2.0 HDi 110	79 kW 1997 cc (RHS(DW10ATED))	03.2002-	132088	25
PEUGEOT	307 Break (3E) / 2.0 HDi 135	100 kW 1997 cc (RHR(DW10BTED4))	02.2004-	132088	25
PEUGEOT	307 Break (3E) / 2.0 HDi 90	66 kW 1997 cc (RHY(DW10TD))	03.2002-	132088	25
PEUGEOT	307 CC (3B) / 2.0 HDi 135	100 kW 1997 cc (RHR(DW10BTED4))	06.2005-	132088	25
PEUGEOT	307 Estate (3E) / 2.0 HDi 110	79 kW 1997 cc	03.2002-	132088	25
PEUGEOT	307 Estate (3E) / 2.0 HDi 135	100 kW 1997 cc	02.2004-	132088	25
PEUGEOT	307 Estate (3E) / 2.0 HDi 90	66 kW 1997 cc	03.2002-	132088	25
PEUGEOT	307 SW (3H) / 2.0 HDi 110	79 kW 1997 cc (RHS(DW10ATED))	03.2002-	132088	25
PEUGEOT	307 SW (3H) / 2.0 HDi 135	100 kW 1997 cc (RHR(DW10BTED4))	02.2004-	132088	25
PEUGEOT	307 SW (3H) / 2.0 HDi 90	66 kW 1997 cc (RHY(DW10TD))	03.2002-	132088	25
PEUGEOT	308 (4A, 4C) / 2.0 HDi	100 kW 1997 cc (RHR(DW10BTED4))	09.2007-	132088	25
PEUGEOT	308 CC / 2.0 HDi	100 kW 1997 cc (RHR(DW10BTED4))	04.2009-	132088	25
PEUGEOT	308 SW / 2.0 HDi	100 kW 1997 cc (RHR(DW10BTED4))	09.2007-	132088	25
PEUGEOT	308 SW Kombi / 2.0 HDi	100 kW 1997 cc	09.2007-	132088	25
PEUGEOT	309 (10C, 10A) / 1.9 D	47 kW 1697 cc	06.1986-07.1989	132051	26
PEUGEOT	309 (10C, 10A) / 1.9 D	47 kW 1905 cc	06.1986-07.1989	132052	27
PEUGEOT	309 I (10C, 10A) / 1.9 D	47 kW 1905 cc	06.1986-07.1989	132051	26
PEUGEOT	309 I (10C, 10A) / 1.9 D	47 kW 1905 cc	06.1986-07.1989	132052	27



	Modell Model	Motor Engine	 Baujahr Construction year	HÜCO-NO.	Seite Page
PEUGEOT	309 II (3C, 3A) / 1.8 D	44 kW 1769 cc	07.1989-12.1993	132052	27
PEUGEOT	309 II (3C, 3A) / 1.8 D	44 kW 1769 cc	07.1989-12.1993	132080	29
PEUGEOT	309 II (3C, 3A) / 1.8 D	44 kW 1769 cc (161A(XUD7))	07.1989-12.1993	132051	26
PEUGEOT	309 II (3C, 3A) / 1.8 TD	57 kW 1580 cc	08.1989-12.1993	132051	26
PEUGEOT	309 II (3C, 3A) / 1.8 TD	57 kW 1769 cc	08.1989-12.1993	132052	27
PEUGEOT	309 II (3C, 3A) / 1.9 D	47 kW 1905 cc	07.1989-12.1993	132052	27
PEUGEOT	309 II (3C, 3A) / 1.9 D	47 kW 1905 cc	07.1989-12.1993	132080	29
PEUGEOT	309 II (3C, 3A) / 1.9 D	47 kW 1905 cc (DJZ(XUD9Y))	07.1989-12.1993	132051	26
PEUGEOT	309 Mk II (3C, 3A) / 1.8 D	44 kW 1769 cc	07.1989-12.1993	132051	26
PEUGEOT	309 Mk II (3C, 3A) / 1.8 D	44 kW 1769 cc	07.1989-12.1993	132052	27
PEUGEOT	309 Mk II (3C, 3A) / 1.8 D	44 kW 1769 cc	07.1989-12.1993	132080	29
PEUGEOT	309 Mk II (3C, 3A) / 1.8 TD	57 kW 1769 cc	08.1989-12.1993	132051	26
PEUGEOT	309 Mk II (3C, 3A) / 1.8 TD	57 kW 1769 cc	08.1989-12.1993	132052	27
PEUGEOT	309 Mk II (3C, 3A) / 1.9 D	47 kW 1905 cc	07.1989-12.1993	132051	26
PEUGEOT	309 Mk II (3C, 3A) / 1.9 D	47 kW 1905 cc	07.1989-12.1993	132052	27
PEUGEOT	309 Mk II (3C, 3A) / 1.9 D	47 kW 1905 cc	07.1989-12.1993	132080	29
PEUGEOT	405 (15B) / 1.8 Turbo D.	66 kW 1769 cc	03.1988-12.1992	132052	27
PEUGEOT	405 (15B) / 1.8 Turbo D.	66 kW 1905 cc	03.1988-12.1992	132051	26
PEUGEOT	405 (15B) / 1.9 D	47 kW 1905 cc (DJZ(XUD9Y))	07.1988-09.1992	132080	29
PEUGEOT	405 (15B) / 1.9 D	51 kW 1905 cc	03.1988-12.1992	132052	27
PEUGEOT	405 (15B) / 1.9 D	51 kW 1905 cc	03.1988-12.1992	132080	29
PEUGEOT	405 (15B) / 1.9 D	51 kW 1905 cc (D9B(XUD9A))	03.1988-12.1992	132051	26
PEUGEOT	405 Estate (15E) / 1.8 TD	66 kW 1769 cc	10.1988-08.1992	132052	27
PEUGEOT	405 Estate (15E) / 1.8 TD	66 kW 1975 cc	10.1988-08.1992	132051	26
PEUGEOT	405 Estate (15E) / 1.9 D	47 kW 1905 cc (DJZ(XUD9Y))	10.1988-08.1992	132080	29
PEUGEOT	405 Estate (15E) / 1.9 D	51 kW 1905 cc	10.1988-08.1992	132052	27
PEUGEOT	405 Estate (15E) / 1.9 D	51 kW 1905 cc	10.1988-08.1992	132080	29
PEUGEOT	405 Estate (15E) / 1.9 D	51 kW 1905 cc (D9B(XUD9A))	10.1988-08.1992	132051	26
PEUGEOT	405 I (15B) / 1.8 Turbo D.	66 kW 1769 cc	03.1988-12.1992	132051	26
PEUGEOT	405 I (15B) / 1.8 Turbo D.	66 kW 1769 cc	03.1988-12.1992	132052	27
PEUGEOT	405 I (15B) / 1.9 D	47 kW 1905 cc	07.1988-09.1992	132080	29
PEUGEOT	405 I (15B) / 1.9 D	51 kW 1905 cc	03.1988-12.1992	132051	26
PEUGEOT	405 I (15B) / 1.9 D	51 kW 1905 cc	03.1988-12.1992	132052	27
PEUGEOT	405 I (15B) / 1.9 D	51 kW 1905 cc	03.1988-12.1992	132080	29
PEUGEOT	405 I Break (15E) / 1.8 TD	66 kW 1769 cc	10.1988-08.1992	132051	26
PEUGEOT	405 I Break (15E) / 1.8 TD	66 kW 1769 cc	10.1988-08.1992	132052	27
PEUGEOT	405 I Break (15E) / 1.9 D	47 kW 1905 cc	10.1988-08.1992	132080	29
PEUGEOT	405 I Break (15E) / 1.9 D	51 kW 1905 cc	10.1988-08.1992	132051	26
PEUGEOT	405 I Break (15E) / 1.9 D	51 kW 1905 cc	10.1988-08.1992	132052	27
PEUGEOT	405 I Break (15E) / 1.9 D	51 kW 1905 cc	10.1988-08.1992	132080	29
PEUGEOT	405 I Stufenh. (15B) / 1.8 Turbo D.	66 kW 1769 cc	03.1988-12.1992	132051	26
PEUGEOT	405 I Stufenh. (15B) / 1.8 Turbo D.	66 kW 1769 cc	03.1988-12.1992	132052	27
PEUGEOT	405 I Stufenh. (15B) / 1.9 D	47 kW 1905 cc	07.1988-09.1992	132080	29
PEUGEOT	405 I Stufenh. (15B) / 1.9 D	51 kW 1905 cc	03.1988-12.1992	132051	26
PEUGEOT	405 I Stufenh. (15B) / 1.9 D	51 kW 1905 cc	03.1988-12.1992	132052	27
PEUGEOT	405 I Stufenh. (15B) / 1.9 D	51 kW 1905 cc	03.1988-12.1992	132080	29
PEUGEOT	405 II (4B) / 1.9 D	47 kW 1905 cc	08.1992-10.1995	132085	30
PEUGEOT	405 II (4B) / 1.9 D	47 kW 1905 cc (DJZ(XUD9Y))	08.1992-10.1995	132080	29
PEUGEOT	405 II (4B) / 1.9 D	50 kW 1905 cc	06.1994-10.1995	132052	27
PEUGEOT	405 II (4B) / 1.9 D	50 kW 1905 cc	06.1994-10.1995	132080	29
PEUGEOT	405 II (4B) / 1.9 D	50 kW 1905 cc (DJY(XUD9A))	06.1994-10.1995	132051	26
PEUGEOT	405 II (4B) / 1.9 TD	66 kW 1905 cc (XUD9TE)	08.1992-10.1995	132081	28
PEUGEOT	405 II Break (4E) / 1.9 D	47 kW 1905 cc (DJZ(XUD9Y))	08.1992-10.1996	132080	29
PEUGEOT	405 II Break (4E) / 1.9 D	50 kW 1905 cc	06.1994-10.1996	132085	30
PEUGEOT	405 II Break (4E) / 1.9 D	50 kW 1905 cc (DJY(XUD9A))	06.1994-10.1996	132080	29
PEUGEOT	405 II Break (4E) / 1.9 D	51 kW 1905 cc	09.1993-12.1995	132083	29
PEUGEOT	405 II Break (4E) / 1.9 D	51 kW 1905 cc (XUD9)	09.1993-12.1995	132080	29
PEUGEOT	405 II Break (4E) / 1.9 TD	66 kW 1905 cc (XUD9TE)	08.1992-10.1996	132081	28
PEUGEOT	405 II Stufenh. (4B) / 1.9 D	47 kW 1905 cc	08.1992-10.1995	132080	29
PEUGEOT	405 II Stufenh. (4B) / 1.9 D	47 kW 1905 cc	08.1992-10.1995	132085	30
PEUGEOT	405 II Stufenh. (4B) / 1.9 D	50 kW 1905 cc	06.1994-10.1995	132051	26
PEUGEOT	405 II Stufenh. (4B) / 1.9 D	50 kW 1905 cc	06.1994-10.1995	132052	27
PEUGEOT	405 II Stufenh. (4B) / 1.9 D	50 kW 1905 cc	06.1994-10.1995	132080	29
PEUGEOT	405 II Stufenh. (4B) / 1.9 TD	66 kW 1905 cc	08.1992-10.1995	132081	28
PEUGEOT	405 Mk II (4B) / 1.9 D	47 kW 1905 cc	08.1992-10.1995	132080	29
PEUGEOT	405 Mk II (4B) / 1.9 D	47 kW 1905 cc	08.1992-10.1995	132085	30
PEUGEOT	405 Mk II (4B) / 1.9 D	50 kW 1905 cc	06.1994-10.1995	132051	26



	Modell Model	Motor Engine	Baujahr Construction year	HÜCO-NO.	Seite Page
PEUGEOT	405 Mk II (4B) / 1.9 D	50 kW 1905 cc	06.1994-10.1995	132052	27
PEUGEOT	405 Mk II (4B) / 1.9 D	50 kW 1905 cc	06.1994-10.1995	132080	29
PEUGEOT	405 Mk II (4B) / 1.9 TD	66 kW 1905 cc	08.1992-10.1995	132081	28
PEUGEOT	405 Mk II Estate (4E) / 1.9 D	47 kW 1905 cc	08.1992-10.1996	132080	29
PEUGEOT	405 Mk II Estate (4E) / 1.9 D	50 kW 1905 cc	06.1994-10.1996	132080	29
PEUGEOT	405 Mk II Estate (4E) / 1.9 D	50 kW 1905 cc	06.1994-10.1996	132085	30
PEUGEOT	405 Mk II Estate (4E) / 1.9 D	51 kW 1905 cc	09.1993-12.1995	132080	29
PEUGEOT	405 Mk II Estate (4E) / 1.9 D	51 kW 1905 cc	09.1993-12.1995	132083	29
PEUGEOT	405 Mk II Estate (4E) / 1.9 TD	66 kW 1905 cc	08.1992-10.1996	132081	28
PEUGEOT	406 (8B) / 1.9 D	55 kW 1905 cc (DHW(XUD9SD))	10.1996-05.2004	132088	25
PEUGEOT	406 (8B) / 1.9 TD	66 kW 1905 cc (XUD9TE)	01.1996-05.2004	132081	28
PEUGEOT	406 (8B) / 1.9 TD	68 kW 1905 cc (XUD9TE)	01.1996-05.2004	132081	28
PEUGEOT	406 (8B) / 2.0 HDi 110	79 kW 1997 cc (RHS(DW10ATED))	08.2001-05.2004	132088	25
PEUGEOT	406 (8B) / 2.0 HDi 110	80 kW 1997 cc (RHZ(DW10ATED))	06.1998-08.2001	132088	25
PEUGEOT	406 (8B) / 2.0 HDi 90	66 kW 1997 cc (RHY(DW10TD))	02.1999-05.2004	132088	25
PEUGEOT	406 (8B) / 2.1 TD 12V	80 kW 2088 cc	01.1996-05.2004	132080	29
PEUGEOT	406 (8B) / 2.1 TD 12V	80 kW 2088 cc	01.1996-05.2004	132081	28
PEUGEOT	406 (8B) / 2.1 TD 12V	80 kW 2088 cc (XUD11BTE)	01.1996-05.2004	132045	23
PEUGEOT	406 (8B) / 2.2 HDi	98 kW 2179 cc (4HX(DW12TED4/FAP))	03.2000-05.2004	132088	25
PEUGEOT	406 Break (8E/F) / 1.9 D	55 kW 1905 cc	10.1996-10.2004	132081	28
PEUGEOT	406 Break (8E/F) / 1.9 D	55 kW 1905 cc (XUD9SD)	10.1996-10.2004	132088	25
PEUGEOT	406 Break (8E/F) / 1.9 TD	66 kW 1905 cc (XUD9TE)	10.1996-10.2004	132081	28
PEUGEOT	406 Break (8E/F) / 2.0 HDi 110	79 kW 1997 cc (RHS(DW10ATED))	08.2001-10.2004	132088	25
PEUGEOT	406 Break (8E/F) / 2.0 HDi 110	80 kW 1997 cc (RHZ(DW10ATED))	02.1999-04.2004	132088	25
PEUGEOT	406 Break (8E/F) / 2.0 HDi 90	66 kW 1997 cc (RHY(DW10TD))	02.1999-10.2004	132088	25
PEUGEOT	406 Break (8E/F) / 2.1 TD 12V	80 kW 2088 cc	10.1996-10.2004	132081	28
PEUGEOT	406 Break (8E/F) / 2.1 TD 12V	80 kW 2088 cc (XUD11BTE)	10.1996-10.2004	132080	29
PEUGEOT	406 Break (8E/F) / 2.2 HDi	98 kW 2179 cc (4HX(DW12TED4/FAP))	03.2000-10.2004	132088	25
PEUGEOT	406 Coupe (8C) / 2.2 HDi	98 kW 2179 cc (4HX(DW12TED4/FAP))	03.2000-12.2004	132088	25
PEUGEOT	406 Estate (8E/F) / 1.9 D	55 kW 1905 cc	10.1996-10.2004	132081	28
PEUGEOT	406 Estate (8E/F) / 1.9 D	55 kW 1905 cc	10.1996-10.2004	132088	25
PEUGEOT	406 Estate (8E/F) / 1.9 TD	66 kW 1905 cc	10.1996-10.2004	132081	28
PEUGEOT	406 Estate (8E/F) / 2.0 HDi 110	79 kW 1997 cc	08.2001-10.2004	132088	25
PEUGEOT	406 Estate (8E/F) / 2.0 HDi 110	80 kW 1997 cc	02.1999-04.2004	132088	25
PEUGEOT	406 Estate (8E/F) / 2.0 HDi 90	66 kW 1997 cc	02.1999-10.2004	132088	25
PEUGEOT	406 Estate (8E/F) / 2.1 TD 12V	80 kW 2088 cc	10.1996-10.2004	132080	29
PEUGEOT	406 Estate (8E/F) / 2.1 TD 12V	80 kW 2088 cc	10.1996-10.2004	132081	28
PEUGEOT	406 Estate (8E/F) / 2.2 HDi	98 kW 2179 cc	03.2000-10.2004	132088	25
PEUGEOT	406 Stufenh. (8B) / 1.9 D	55 kW 1905 cc	10.1996-05.2004	132088	25
PEUGEOT	406 Stufenh. (8B) / 1.9 TD	66 kW 1905 cc	01.1996-05.2004	132081	28
PEUGEOT	406 Stufenh. (8B) / 1.9 TD	68 kW 1905 cc	01.1996-05.2004	132081	28
PEUGEOT	406 Stufenh. (8B) / 2.0 HDi 110	79 kW 1997 cc	08.2001-05.2004	132088	25
PEUGEOT	406 Stufenh. (8B) / 2.0 HDi 110	80 kW 1997 cc	06.1998-08.2001	132088	25
PEUGEOT	406 Stufenh. (8B) / 2.0 HDi 90	66 kW 1997 cc	02.1999-05.2004	132088	25
PEUGEOT	406 Stufenh. (8B) / 2.1 TD 12V	80 kW 2088 cc	01.1996-05.2004	132045	23
PEUGEOT	406 Stufenh. (8B) / 2.1 TD 12V	80 kW 2088 cc	01.1996-05.2004	132080	29
PEUGEOT	406 Stufenh. (8B) / 2.1 TD 12V	80 kW 2088 cc	01.1996-05.2004	132081	28
PEUGEOT	406 Stufenh. (8B) / 2.2 HDi	98 kW 2179 cc	03.2000-05.2004	132088	25
PEUGEOT	407 (6D_) / 2.0 HDi 135	100 kW 1997 cc (RHR(DW10BTED4))	05.2004-	132088	25
PEUGEOT	407 Coupe (6C_) / 2.0 HDi	100 kW 1997 cc (RHR(DW10BTED4))	10.2005-	132088	25
PEUGEOT	407 Stufenh. (6D_) / 2.0 HDi 135	100 kW 1997 cc	05.2004-	132088	25
PEUGEOT	407 SW (6E_) / 2.0 HDi 135	100 kW 1997 cc (RHR(DW10BTED4))	05.2004-	132088	25
PEUGEOT	504 (A_, M_) / 2.1 D (A20, M20)	48 kW 1357 cc	02.1971-07.1986	132050	26
PEUGEOT	504 (A_, M_) / 2.1 D (A20, M20)	48 kW 2112 cc	02.1971-07.1986	132051	26
PEUGEOT	504 (A_, M_) / 2.1 D (A20, M20)	48 kW 2112 cc	02.1971-07.1986	132052	27
PEUGEOT	504 (A_, M_) / 2.3 D (A40, A45)	51 kW 2112 cc	07.1975-12.1983	132050	26
PEUGEOT	504 (A_, M_) / 2.3 D (A40, A45)	51 kW 2304 cc	07.1975-12.1983	132051	26
PEUGEOT	504 (A_, M_) / 2.3 D (A40, A45)	51 kW 2304 cc	07.1975-12.1983	132052	27
PEUGEOT	504 Break (D_, F_) / 2.1 D (E20, F20)	48 kW 2112 cc	04.1971-07.1986	132051	26
PEUGEOT	504 Break (D_, F_) / 2.1 D (E20, F20)	48 kW 2112 cc	04.1971-07.1986	132052	27
PEUGEOT	504 Break (D_, F_) / 2.1 D (E20, F20)	48 kW 2304 cc	04.1971-07.1986	132050	26
PEUGEOT	504 Break (D_, F_) / 2.3 D (D40, F40)	51 kW 2112 cc	07.1975-07.1986	132050	26
PEUGEOT	504 Break (D_, F_) / 2.3 D (D40, F40)	51 kW 2304 cc	07.1975-07.1986	132051	26
PEUGEOT	504 Pick-up (E_) / 2.3 D	51 kW 2304 cc	01.1980-12.1989	132051	26
PEUGEOT	504 Pick-up (E_) / 2.3 D	51 kW 2304 cc	01.1980-12.1989	132052	27
PEUGEOT	504 Pick-up (E_) / 2.3 D	51 kW 2461 cc	01.1980-12.1989	132050	26
PEUGEOT	504 Stufenh. (A_, M_) / 2.1 D	48 kW 2112 cc	02.1971-07.1986	132050	26



Modell
Model

Motor
Engine



Baujahr
Construction year

HÜCO-NO. Seite
Page

Modell Model	Motor Engine	Baujahr Construction year	HÜCO-NO.	Seite Page
PEUGEOT 504 Stufenh. (A_, M_) / 2.1 D	48 kW 2112 cc	02.1971-07.1986	132051	26
PEUGEOT 504 Stufenh. (A_, M_) / 2.1 D	48 kW 2112 cc	02.1971-07.1986	132052	27
PEUGEOT 504 Stufenh. (A_, M_) / 2.3 D	51 kW 2304 cc	07.1975-12.1983	132050	26
PEUGEOT 504 Stufenh. (A_, M_) / 2.3 D	51 kW 2304 cc	07.1975-12.1983	132051	26
PEUGEOT 504 Stufenh. (A_, M_) / 2.3 D	51 kW 2304 cc	07.1975-12.1983	132052	27
PEUGEOT 505 (551A) / 2.2 GTI	90 kW 1968 cc	08.1983-12.1993	132040	18
PEUGEOT 505 (551A) / 2.2 GTI	96 kW 2498 cc	08.1983-12.1993	132040	18
PEUGEOT 505 (551A) / 2.3 Turbo D.	59 kW 2165 cc	09.1980-06.1986	132050	26
PEUGEOT 505 (551A) / 2.3 Turbo D.	59 kW 2304 cc	09.1980-06.1986	132051	26
PEUGEOT 505 (551A) / 2.3 Turbo D.	59 kW 2304 cc	09.1980-06.1986	132052	27
PEUGEOT 505 (551A) / 2.5 D	51 kW 2498 cc	10.1981-11.1990	132052	27
PEUGEOT 505 (551A) / 2.5 D	51 kW 2933 cc	10.1981-11.1990	132051	26
PEUGEOT 505 (551A) / 2.5 D	55 kW 1968 cc	06.1981-12.1993	132051	26
PEUGEOT 505 (551A) / 2.5 D	55 kW 2498 cc	06.1981-12.1993	132052	27
PEUGEOT 505 (551A) / 2.5 Turbo D.	66 kW 1997 cc	10.1983-12.1993	132051	26
PEUGEOT 505 (551A) / 2.5 Turbo D.	66 kW 2498 cc	10.1983-12.1993	132052	27
PEUGEOT 505 (551A) / 2.5 Turbo D.	70 kW 1769 cc	10.1983-12.1990	132051	26
PEUGEOT 505 (551A) / 2.5 Turbo D.	70 kW 2498 cc	10.1983-12.1990	132052	27
PEUGEOT 505 Break (551D) / 2.2 GTI	90 kW 2304 cc	09.1985-12.1986	132040	18
PEUGEOT 505 Break (551D) / 2.3 D	59 kW 1357 cc	04.1982-06.1986	132051	26
PEUGEOT 505 Break (551D) / 2.5 D	51 kW 1968 cc	01.1986-12.1993	132051	26
PEUGEOT 505 Break (551D) / 2.5 D	51 kW 2498 cc	01.1986-12.1993	132052	27
PEUGEOT 505 Break (551D) / 2.5 D	55 kW 2498 cc	08.1983-12.1993	132051	26
PEUGEOT 505 Break (551D) / 2.5 D	55 kW 2498 cc	08.1983-12.1993	132052	27
PEUGEOT 505 Break (551D) / 2.5 Turbo D.	66 kW 2165 cc	10.1985-11.1987	132051	26
PEUGEOT 505 Break (551D) / 2.5 Turbo D.	66 kW 2498 cc	10.1985-11.1987	132052	27
PEUGEOT 604 (561A_) / 2.3 TD	59 kW 2304 cc	09.1979-05.1983	132051	26
PEUGEOT 604 (561A_) / 2.3 TD	59 kW 2304 cc	09.1979-05.1983	132052	27
PEUGEOT 604 (561A_) / 2.3 TD	59 kW 2498 cc	09.1979-05.1983	132050	26
PEUGEOT 604 (561A_) / 2.5 TD	66 kW 2304 cc	08.1983-12.1986	132051	26
PEUGEOT 604 (561A_) / 2.5 TD	66 kW 2498 cc	08.1983-12.1986	132052	27
PEUGEOT 604 Stufenh. (561A_) / 2.3 TD	59 kW 2304 cc	09.1979-05.1983	132050	26
PEUGEOT 604 Stufenh. (561A_) / 2.3 TD	59 kW 2304 cc	09.1979-05.1983	132051	26
PEUGEOT 604 Stufenh. (561A_) / 2.3 TD	59 kW 2304 cc	09.1979-05.1983	132052	27
PEUGEOT 604 Stufenh. (561A_) / 2.5 TD	66 kW 2498 cc	08.1983-12.1986	132051	26
PEUGEOT 604 Stufenh. (561A_) / 2.5 TD	66 kW 2498 cc	08.1983-12.1986	132052	27
PEUGEOT 605 (6B) / 2.1 D	60 kW 2138 cc	06.1989-07.1995	132052	27
PEUGEOT 605 (6B) / 2.1 D	60 kW 2138 cc	06.1989-07.1995	132080	29
PEUGEOT 605 (6B) / 2.1 D	60 kW 2138 cc (P9A(XUD11A))	06.1989-07.1995	132051	26
PEUGEOT 605 (6B) / 2.1 TD 12V	80 kW 2088 cc	08.1994-09.1999	132080	29
PEUGEOT 605 (6B) / 2.1 TD 12V	80 kW 2088 cc	08.1994-09.1999	132081	28
PEUGEOT 605 (6B) / 2.1 TD 12V	80 kW 2088 cc (XUD11BTE)	08.1994-09.1999	132051	26
PEUGEOT 605 (6B) / 2.1 Turbo D.	80 kW 2088 cc	06.1989-09.1999	132052	27
PEUGEOT 605 (6B) / 2.1 Turbo D.	80 kW 2088 cc	06.1989-09.1999	132080	29
PEUGEOT 605 (6B) / 2.1 Turbo D.	80 kW 2088 cc (DJZ(XUD9Y))	06.1989-09.1999	132051	26
PEUGEOT 605 (6B) / 2.5 Turbo D.	95 kW 2446 cc (THY(DK5ATE))	07.1994-09.1999	132088	25
PEUGEOT 605 Stufenh. (6B) / 2.1 D	60 kW 2138 cc	06.1989-07.1995	132051	26
PEUGEOT 605 Stufenh. (6B) / 2.1 D	60 kW 2138 cc	06.1989-07.1995	132052	27
PEUGEOT 605 Stufenh. (6B) / 2.1 D	60 kW 2138 cc	06.1989-07.1995	132080	29
PEUGEOT 605 Stufenh. (6B) / 2.1 TD 12V	80 kW 2088 cc	08.1994-09.1999	132051	26
PEUGEOT 605 Stufenh. (6B) / 2.1 TD 12V	80 kW 2088 cc	08.1994-09.1999	132080	29
PEUGEOT 605 Stufenh. (6B) / 2.1 TD 12V	80 kW 2088 cc	08.1994-09.1999	132081	28
PEUGEOT 605 Stufenh. (6B) / 2.1 Turbo D.	80 kW 2088 cc	06.1989-09.1999	132051	26
PEUGEOT 605 Stufenh. (6B) / 2.1 Turbo D.	80 kW 2088 cc	06.1989-09.1999	132052	27
PEUGEOT 605 Stufenh. (6B) / 2.1 Turbo D.	80 kW 2088 cc	06.1989-09.1999	132080	29
PEUGEOT 605 Stufenh. (6B) / 2.5 Turbo D.	95 kW 2446 cc	07.1994-09.1999	132088	25
PEUGEOT 607 (9D, 9U) / 2.0 HDI	100 kW 1997 cc (RHR(DW10BTED4))	09.2005-	132088	25
PEUGEOT 607 (9D, 9U) / 2.0 HDi	79 kW 1997 cc (RHS(DW10ATED))	03.2001-07.2004	132088	25
PEUGEOT 607 (9D, 9U) / 2.0 HDi	80 kW 1997 cc (RHZ(DW10ATED))	05.2000-	132088	25
PEUGEOT 607 (9D, 9U) / 2.2 HDI	98 kW 2179 cc (4HX(DW12TED4/FAP))	02.2000-	132088	25
PEUGEOT 607 Stufenh. (9D, 9U) / 2.0 HDI	100 kW 1997 cc	09.2005-	132088	25
PEUGEOT 607 Stufenh. (9D, 9U) / 2.0 HDi	79 kW 1997 cc	03.2001-07.2004	132088	25
PEUGEOT 607 Stufenh. (9D, 9U) / 2.0 HDi	80 kW 1997 cc	05.2000-	132088	25
PEUGEOT 607 Stufenh. (9D, 9U) / 2.0 HDi	80 kW 1997 cc	05.2000-	132088	25
PEUGEOT 607 Stufenh. (9D, 9U) / 2.2 HDI	98 kW 2179 cc	02.2000-	132088	25
PEUGEOT 806 (221) / 1.9 TD	66 kW 1905 cc (XUD9TE)	07.1995-08.2002	132081	28
PEUGEOT 806 (221) / 1.9 TD	68 kW 1905 cc (XUD9TE)	05.1997-08.2002	132081	28
PEUGEOT 806 (221) / 2.0 HDI	80 kW 1997 cc (RHZ(DW10ATED))	08.1999-08.2002	132088	25



	Modell Model	Motor Engine	Baujahr Construction year	HÜCO-NO.	Seite Page
PEUGEOT	806 (221) / 2.0 HDI 16V	80 kW 1997 cc (RHW(DW10ATED4))	08.1999-08.2002	132088	25
PEUGEOT	806 (221) / 2.1 td 12V	80 kW 2088 cc	06.1996-08.1999	132081	28
PEUGEOT	806 (221) / 2.1 td 12V	80 kW 2088 cc (XUD11BTE)	06.1996-08.1999	132080	29
PEUGEOT	807 (E) / 2.0 HDI	100 kW 1997 cc (RHR(DW10BTED4))	06.2006-	132088	25
PEUGEOT	807 (E) / 2.0 HDi	79 kW 1997 cc (RHK(DW10UTED4))	06.2002-	132088	25
PEUGEOT	807 (E) / 2.0 HDi	88 kW 1997 cc (RHK(DW10UTED4))	11.2006-	132088	25
PEUGEOT	807 (E) / 2.2 HDi	94 kW 2179 cc (4HX(DW12TED4/FAP))	06.2002-	132088	25
PEUGEOT	BOXER Bus (230P) / 1.9 D	51 kW 1905 cc	03.1994-04.2002	132083	29
PEUGEOT	BOXER Bus (230P) / 1.9 D	51 kW 1905 cc (D8C(XUD9AU))	03.1994-04.2002	132080	29
PEUGEOT	BOXER Bus (230P) / 1.9 TD	66 kW 1905 cc (XUD9TE)	08.1994-04.2002	132081	28
PEUGEOT	BOXER Bus (230P) / 2.5 D	63 kW 1461 cc	08.1994-04.2002	132085	30
PEUGEOT	BOXER Bus (230P) / 2.5 TD	76 kW 1905 cc	07.1994-04.2002	132085	30
PEUGEOT	BOXER Bus (230P) / 2.5 TD 4x4	76 kW 1527 cc	07.1996-04.2002	132085	30
PEUGEOT	BOXER Bus (244, Z_) / 2.0 HDi	62 kW 1997 cc (RHV(DW10UTD))	04.2002-	132088	25
PEUGEOT	BOXER Bus / 2.2 HDi 100	74 kW 2198 cc (4HV)	04.2006-	132088	25
PEUGEOT	BOXER Bus / 2.2 HDi 120	88 kW 2198 cc (4HU)	04.2006-	132088	25
PEUGEOT	BOXER Kasten (230L) / 1.9 D	50 kW 1905 cc	07.1999-04.2002	132083	29
PEUGEOT	BOXER Kasten (230L) / 1.9 D	50 kW 1905 cc (DJY(XUD9A))	07.1999-04.2002	132080	29
PEUGEOT	BOXER Kasten (230L) / 1.9 D	51 kW 1905 cc	03.1994-04.2002	132083	29
PEUGEOT	BOXER Kasten (230L) / 1.9 D	51 kW 1905 cc (D8C(XUD9AU))	03.1994-04.2002	132080	29
PEUGEOT	BOXER Kasten (230L) / 1.9 DT 4x4	66 kW 1905 cc (XUD9TE)	03.1996-09.1998	132081	28
PEUGEOT	BOXER Kasten (230L) / 1.9 TD	66 kW 1905 cc (XUD9TE)	07.1999-04.2002	132081	28
PEUGEOT	BOXER Kasten (230L) / 2.0 HDI	62 kW 1997 cc (RHV(DW10UTD))	08.2001-04.2002	132088	25
PEUGEOT	BOXER Kasten (230L) / 2.5 D	63 kW 1905 cc	03.1994-04.2002	132085	30
PEUGEOT	BOXER Kasten (230L) / 2.5 D 4x4	63 kW 1905 cc	07.1999-04.2002	132085	30
PEUGEOT	BOXER Kasten (230L) / 2.5 TD	76 kW 2446 cc	03.1994-04.2002	132085	30
PEUGEOT	BOXER Kasten (244) / 2.0 HDi	62 kW 1997 cc (RHV(DW10UTD))	04.2002-	132088	25
PEUGEOT	BOXER Kasten / 2.2 HDi 100	74 kW 2198 cc (4HV)	04.2006-	132088	25
PEUGEOT	BOXER Kasten / 2.2 HDi 120	88 kW 2198 cc (4HU)	04.2006-	132088	25
PEUGEOT	BOXER Pritsche (244) / 2.0 HDi	62 kW 1997 cc (RHV(DW10UTD))	04.2002-	132088	25
PEUGEOT	BOXER Pritsche (ZCT_) / 1.9 TD	66 kW 1905 cc (XUD9TE)	12.1998-04.2002	132081	28
PEUGEOT	BOXER Pritsche (ZCT_) / 2.5 D	63 kW 2155 cc	03.1994-04.2002	132085	30
PEUGEOT	BOXER Pritsche (ZCT_) / 2.5 TD	76 kW 2446 cc	03.1994-04.2002	132085	30
PEUGEOT	BOXER Pritsche / 2.2 HDi 100	74 kW 2198 cc (4HV)	04.2006-	132088	25
PEUGEOT	BOXER Pritsche / 2.2 HDi 120	88 kW 2198 cc (4HU)	04.2006-	132088	25
PEUGEOT	EXPERT (224) / 1.9 D	51 kW 1868 cc (WJY(DW8B))	12.2003-	132088	25
PEUGEOT	EXPERT (224) / 1.9 D	51 kW 1905 cc	02.1996-	132083	29
PEUGEOT	EXPERT (224) / 1.9 TD	66 kW 1905 cc (XUD9TE)	02.1996-	132081	28
PEUGEOT	EXPERT (224) / 1.9 TD	68 kW 1905 cc (XUD9TE)	02.1996-	132081	28
PEUGEOT	EXPERT (224) / 2.0 HDi	69 kW 1997 cc (RHX(DW10BTED))	10.2000-11.2003	132088	25
PEUGEOT	EXPERT (224) / 2.0 HDi	80 kW 1997 cc (RHW(DW10ATED4))	07.2000-	132088	25
PEUGEOT	EXPERT (224) / 2.0 HDi	80 kW 1997 cc (RHZ(DW10ATED))	07.2000-	132088	25
PEUGEOT	EXPERT Kasten (222) / 1.9 D	51 kW 1905 cc	02.1996-	132083	29
PEUGEOT	EXPERT Kasten (222) / 1.9 D 70	51 kW 1868 cc (WJY(DW8B))	12.1998-	132088	25
PEUGEOT	EXPERT Kasten (222) / 1.9 TD	66 kW 1905 cc (XUD9TE)	02.1996-	132081	28
PEUGEOT	EXPERT Kasten (222) / 1.9 TD	68 kW 1905 cc (XUD9TE)	02.1996-	132081	28
PEUGEOT	EXPERT Kasten (222) / 2.0 HDi	69 kW 1997 cc (RHX(DW10BTED))	07.2000-	132088	25
PEUGEOT	EXPERT Kasten (222) / 2.0 HDi	80 kW 1997 cc (RHW(DW10ATED4))	07.2000-	132088	25
PEUGEOT	EXPERT Kasten (222) / 2.0 HDi	80 kW 1997 cc (RHZ(DW10ATED))	07.2000-	132088	25
PEUGEOT	EXPERT Kasten / 2.0 HDi 120	88 kW 1997 cc (RHK(DW10UTED4))	01.2007-	132088	25
PEUGEOT	EXPERT Kasten / 2.0 HDi 140	100 kW 1997 cc (RHR(DW10BTED4))	01.2007-	132088	25
PEUGEOT	EXPERT Pritsche (223) / 1.9 D	51 kW 1868 cc (WJY(DW8B))	06.1998-11.2003	132088	25
PEUGEOT	EXPERT Pritsche (223) / 1.9 D	51 kW 1905 cc	02.1996-	132083	29
PEUGEOT	EXPERT Pritsche (223) / 1.9 TD	66 kW 1905 cc (XUD9TE)	02.1996-	132081	28
PEUGEOT	EXPERT Pritsche (223) / 1.9 TD	68 kW 1905 cc (XUD9TE)	02.1996-	132081	28
PEUGEOT	EXPERT Pritsche (223) / 2.0 HDi	69 kW 1997 cc (RHX(DW10BTED))	10.2000-10.2006	132088	25
PEUGEOT	EXPERT Pritsche / 2.0 HDi 120	88 kW 1997 cc (RHK(DW10UTED4))	01.2007-	132088	25
PEUGEOT	EXPERT Pritsche / 2.0 HDi 140	100 kW 1997 cc (RHR(DW10BTED4))	01.2007-	132088	25
PEUGEOT	EXPERT Tepee (VF3V_) / 2.0 HDi 120	88 kW 1997 cc (RHK(DW10UTED4))	01.2007-	132088	25
PEUGEOT	EXPERT Tepee (VF3V_) / 2.0 HDi 120 4x4	88 kW 1997 cc (RHK(DW10UTED4))	01.2007-	132088	25
PEUGEOT	EXPERT Tepee (VF3V_) / 2.0 HDi 140	100 kW 1997 cc (RHR(DW10BTED4))	01.2007-	132088	25
PEUGEOT	EXPERT Van (222) / 1.9 D	51 kW 1905 cc	02.1996-	132083	29
PEUGEOT	EXPERT Van (222) / 1.9 D 70	51 kW 1868 cc	12.1998-	132088	25
PEUGEOT	EXPERT Van (222) / 1.9 TD	66 kW 1905 cc	02.1996-	132081	28
PEUGEOT	EXPERT Van (222) / 1.9 TD	68 kW 1905 cc	02.1996-	132081	28
PEUGEOT	EXPERT Van (222) / 2.0 HDi	69 kW 1997 cc	07.2000-	132088	25
PEUGEOT	EXPERT Van (222) / 2.0 HDi	80 kW 1997 cc	07.2000-	132088	25



Modell
Model

Motor
Engine



Baujahr
Construction year

HÜCO-NO. Seite
Page

PEUGEOT	J5 Bus (280P) / 2.5 D	54 kW 1361 cc	09.1981-09.1990	132050	26
PEUGEOT	J5 Bus (290P) / 1.9 D	51 kW 1905 cc	10.1990-	132052	27
PEUGEOT	J5 Bus (290P) / 1.9 D	51 kW 1905 cc	10.1990-	132080	29
PEUGEOT	J5 Bus (290P) / 1.9 D	51 kW 1905 cc (D9B(XUD9A))	10.1990-	132051	26
PEUGEOT	J5 Bus (290P) / 2.5 D	54 kW 1905 cc	10.1990-	132050	26
PEUGEOT	J5 Bus (290P) / 2.5 D	54 kW 2500 cc	10.1990-	132051	26
PEUGEOT	J5 Bus (290P) / 2.5 D	54 kW 2500 cc	10.1990-	132052	27
PEUGEOT	J5 Bus (290P) / 2.5 D 4x4	54 kW 2498 cc	10.1990-	132050	26
PEUGEOT	J5 Bus (290P) / 2.5 D 4x4	54 kW 2500 cc	10.1990-	132051	26
PEUGEOT	J5 Bus (290P) / 2.5 D 4x4	54 kW 2500 cc	10.1990-	132052	27
PEUGEOT	J5 Bus (290P) / 2.5 TD	70 kW 2500 cc	10.1990-	132050	26
PEUGEOT	J5 Bus (290P) / 2.5 TD	70 kW 2500 cc	10.1990-	132051	26
PEUGEOT	J5 Bus (290P) / 2.5 TD	70 kW 2500 cc	10.1990-	132052	27
PEUGEOT	J5 Bus (290P) / 2.5 TD 4x4	70 kW 2500 cc	10.1990-	132050	26
PEUGEOT	J5 Bus (290P) / 2.5 TD 4x4	70 kW 2500 cc	10.1990-	132051	26
PEUGEOT	J5 Bus (290P) / 2.5 TD 4x4	70 kW 2500 cc	10.1990-	132052	27
PEUGEOT	J5 Kasten (280L) / 1.9 D	51 kW 1905 cc	09.1987-08.1990	132083	29
PEUGEOT	J5 Kasten (280L) / 1.9 D	51 kW 1905 cc (XUD9)	09.1987-08.1990	132080	29
PEUGEOT	J5 Kasten (290L) / 1.9 D	51 kW 1905 cc	10.1990-	132052	27
PEUGEOT	J5 Kasten (290L) / 1.9 D	51 kW 1905 cc	10.1990-	132080	29
PEUGEOT	J5 Kasten (290L) / 1.9 D	51 kW 1905 cc (D9B(XUD9A))	10.1990-	132051	26
PEUGEOT	J5 Kasten (290L) / 2.5 D 4x4	54 kW 2500 cc	10.1990-	132050	26
PEUGEOT	J5 Kasten (290L) / 2.5 D 4x4	54 kW 2500 cc	10.1990-	132051	26
PEUGEOT	J5 Kasten (290L) / 2.5 D 4x4	54 kW 2500 cc	10.1990-	132052	27
PEUGEOT	J5 Kasten (290L) / 2.5 TD 4x4	70 kW 2500 cc	10.1990-	132050	26
PEUGEOT	J5 Kasten (290L) / 2.5 TD 4x4	70 kW 2500 cc	10.1990-	132051	26
PEUGEOT	J5 Kasten (290L) / 2.5 TD 4x4	70 kW 2500 cc	10.1990-	132052	27
PEUGEOT	J5 Pritsche (280L) / 1.9 D	51 kW 1905 cc	09.1987-08.1990	132083	29
PEUGEOT	J5 Pritsche (280L) / 1.9 D	51 kW 1905 cc (XUD9)	09.1987-08.1990	132080	29
PEUGEOT	J5 Pritsche (280L) / 2.5 D	54 kW 2498 cc	09.1981-09.1990	132050	26
PEUGEOT	J5 Pritsche (290L) / 1.9 D	51 kW 1905 cc	10.1990-	132052	27
PEUGEOT	J5 Pritsche (290L) / 1.9 D	51 kW 1905 cc	10.1990-	132080	29
PEUGEOT	J5 Pritsche (290L) / 1.9 D	51 kW 1905 cc (D9B(XUD9A))	10.1990-	132051	26
PEUGEOT	J5 Pritsche (290L) / 2.5 D	54 kW 1905 cc	10.1990-	132050	26
PEUGEOT	J5 Pritsche (290L) / 2.5 D	54 kW 2500 cc	10.1990-	132051	26
PEUGEOT	J5 Pritsche (290L) / 2.5 D	54 kW 2500 cc	10.1990-	132052	27
PEUGEOT	J5 Pritsche (290L) / 2.5 D 4x4	54 kW 2500 cc	10.1990-	132050	26
PEUGEOT	J5 Pritsche (290L) / 2.5 D 4x4	54 kW 2500 cc	10.1990-	132051	26
PEUGEOT	J5 Pritsche (290L) / 2.5 TD	70 kW 2500 cc	10.1990-	132050	26
PEUGEOT	J5 Pritsche (290L) / 2.5 TD	70 kW 2500 cc	10.1990-	132051	26
PEUGEOT	J5 Pritsche (290L) / 2.5 TD	70 kW 2500 cc	10.1990-	132052	27
PEUGEOT	J5 Pritsche (290L) / 2.5 TD 4x4	70 kW 2500 cc	10.1990-	132050	26
PEUGEOT	J5 Pritsche (290L) / 2.5 TD 4x4	70 kW 2500 cc	10.1990-	132051	26
PEUGEOT	J9 Bus / 2.3 D	49 kW 2304 cc	03.1980-07.1982	132050	26
PEUGEOT	J9 Bus / 2.3 D	49 kW 2304 cc	03.1980-07.1982	132051	26
PEUGEOT	J9 Bus / 2.3 D	49 kW 2304 cc	03.1980-07.1982	132052	27
PEUGEOT	J9 Bus / 2.5 D	53 kW 2304 cc	08.1982-06.1987	132051	26
PEUGEOT	J9 Bus / 2.5 D	53 kW 2497 cc	08.1982-06.1987	132052	27
PEUGEOT	J9 Kasten / 2.1 D	41 kW 2112 cc	03.1980-06.1987	132052	27
PEUGEOT	J9 Kasten / 2.1 D	41 kW 2497 cc	03.1980-06.1987	132051	26
PEUGEOT	J9 Kasten / 2.3 D	49 kW 2112 cc	03.1980-07.1982	132050	26
PEUGEOT	J9 Kasten / 2.3 D	49 kW 2304 cc	03.1980-07.1982	132051	26
PEUGEOT	J9 Kasten / 2.3 D	49 kW 2304 cc	03.1980-07.1982	132052	27
PEUGEOT	J9 Kasten / 2.5 D	53 kW 2304 cc	07.1982-06.1987	132051	26
PEUGEOT	J9 Kasten / 2.5 D	53 kW 2497 cc	07.1982-06.1987	132052	27
PEUGEOT	J9 Pritsche / 2.3 D	49 kW 2304 cc	03.1980-07.1982	132051	26
PEUGEOT	J9 Pritsche / 2.3 D	49 kW 2304 cc	03.1980-07.1982	132052	27
PEUGEOT	J9 Pritsche / 2.3 D	49 kW 2497 cc	03.1980-07.1982	132050	26
PEUGEOT	J9 Pritsche / 2.5 D	53 kW 2304 cc	07.1982-06.1987	132051	26
PEUGEOT	J9 Pritsche / 2.5 D	53 kW 2497 cc	07.1982-06.1987	132052	27
PEUGEOT	PARTNER Combispacer (5F) / 1.9 D	50 kW 1905 cc	06.1996-	132085	30
PEUGEOT	PARTNER Combispacer (5F) / 1.9 D	50 kW 1905 cc (DJY(XUD9A))	06.1996-	132080	29
PEUGEOT	PARTNER Combispacer (5F) / 1.9 D	51 kW 1868 cc (WJY(DW8B))	12.1998-	132088	25
PEUGEOT	PARTNER Combispacer (5F) / 1.9 D	51 kW 1905 cc	05.1996-12.1998	132083	29
PEUGEOT	PARTNER Combispacer (5F) / 1.9 D	51 kW 1905 cc (XUD9)	05.1996-12.1998	132080	29
PEUGEOT	PARTNER Combispacer (5F) / 1.9 D 4x4	51 kW 1868 cc (WJY(DW8B))	04.2004-08.2005	132088	25
PEUGEOT	PARTNER Combispacer (5F) / 2.0 HDI	66 kW 1997 cc (RHY(DW10TD))	02.2000-	132088	25



	Modell Model	Motor Engine	Baujahr Construction year	HÜCO-NO.	Seite Page
PEUGEOT	PARTNER Combispace (5F) / 2.0 HDi 4x4	66 kW 1997 cc (RHY(DW10TD))	04.2004-08.2005	132088	25
PEUGEOT	PARTNER Kasten (5) / 1.8 D	43 kW 1769 cc	06.1996-	132083	29
PEUGEOT	PARTNER Kasten (5) / 1.8 D	43 kW 1769 cc (A9A(XUD7))	06.1996-	132080	29
PEUGEOT	PARTNER Kasten (5) / 1.9 D	50 kW 1905 cc (DJY(XUD9A))	05.1996-12.1998	132080	29
PEUGEOT	PARTNER Kasten (5) / 1.9 D	51 kW 1868 cc (WJY(DW8B))	06.1996-	132088	25
PEUGEOT	PARTNER Kasten (5) / 1.9 D	51 kW 1905 cc	06.1996-	132085	30
PEUGEOT	PARTNER Kasten (5) / 1.9 D	51 kW 1905 cc (DJY(XUD9A))	06.1996-	132080	29
PEUGEOT	PARTNER Kasten (5) / 1.9 D 4x4	51 kW 1868 cc (WJY(DW8B))	04.2004-	132088	25
PEUGEOT	PARTNER Kasten (5) / 2.0 HDi	66 kW 1997 cc (RHY(DW10TD))	04.2000-	132088	25
PEUGEOT	PARTNER Kasten (5) / 2.0 HDi 4x4	66 kW 1997 cc (RHY(DW10TD))	04.2004-	132088	25
PEUGEOT	PARTNER Van (5) / 1.8 D	43 kW 1769 cc	06.1996-	132080	29
PEUGEOT	PARTNER Van (5) / 1.8 D	43 kW 1769 cc	06.1996-	132083	29
PEUGEOT	PARTNER Van (5) / 1.9 D	50 kW 1905 cc	05.1996-12.1998	132080	29
PEUGEOT	PARTNER Van (5) / 1.9 D	51 kW 1868 cc	06.1996-	132088	25
PEUGEOT	PARTNER Van (5) / 1.9 D	51 kW 1905 cc	06.1996-	132080	29
PEUGEOT	PARTNER Van (5) / 1.9 D	51 kW 1905 cc	06.1996-	132085	30
PEUGEOT	PARTNER Van (5) / 1.9 D 4x4	51 kW 1868 cc	04.2004-	132088	25
PEUGEOT	PARTNER Van (5) / 2.0 HDi	66 kW 1997 cc	04.2000-	132088	25
PEUGEOT	PARTNER Van (5) / 2.0 HDi 4x4	66 kW 1997 cc	04.2004-	132088	25
PEUGEOT	RANCH (5F) / 2.0 HDi 4x4	66 kW 1997 cc	04.2004-08.2005	132088	25
PEUGEOT	RANCH Großraumlim. (5F) / 1.9 D 4x4	51 kW 1868 cc	04.2004-08.2005	132088	25
PEUGEOT	RANCH Großraumlimousine (5F) / 1.9 D	50 kW 1905 cc	06.1996-	132080	29
PEUGEOT	RANCH Großraumlimousine (5F) / 1.9 D	50 kW 1905 cc	06.1996-	132085	30
PEUGEOT	RANCH Großraumlimousine (5F) / 1.9 D	51 kW 1868 cc	12.1998-	132088	25
PEUGEOT	RANCH Großraumlimousine (5F) / 1.9 D	51 kW 1905 cc	05.1996-12.1998	132080	29
PEUGEOT	RANCH Großraumlimousine (5F) / 1.9 D	51 kW 1905 cc	05.1996-12.1998	132083	29
PEUGEOT	RANCH Großraumlimousine (5F) / 2.0 HDi	66 kW 1997 cc	02.2000-	132088	25
PEUGEOT	RANCH Kasten (5) / 1.8 D	43 kW 1769 cc	06.1996-	132080	29
PEUGEOT	RANCH Kasten (5) / 1.8 D	43 kW 1769 cc	06.1996-	132083	29
PEUGEOT	RANCH Kasten (5) / 1.9 D	50 kW 1905 cc	05.1996-12.1998	132080	29
PEUGEOT	RANCH Kasten (5) / 1.9 D	51 kW 1868 cc	06.1996-	132088	25
PEUGEOT	RANCH Kasten (5) / 1.9 D	51 kW 1905 cc	06.1996-	132080	29
PEUGEOT	RANCH Kasten (5) / 1.9 D	51 kW 1905 cc	06.1996-	132085	30
PEUGEOT	RANCH Kasten (5) / 1.9 D 4x4	51 kW 1868 cc	04.2004-	132088	25
PEUGEOT	RANCH Kasten (5) / 2.0 HDi	66 kW 1997 cc	04.2000-	132088	25
PEUGEOT	RANCH Kasten (5) / 2.0 HDi 4x4	66 kW 1997 cc	04.2004-	132088	25
RENAULT	19 (B/C53_) / 1.9 D (B/C534, B/C53J)	47 kW 1697 cc	09.1988-04.1992	132075	32
RENAULT	19 I (B/C53_) / 1.9 D (B/C534, B/C53J)	47 kW 1870 cc	01.1988-04.1992	132075	32
RENAULT	19 I Chamade (L53_) / 1.9 D	47 kW 1868 cc	10.1989-04.1992	132075	32
RENAULT	19 I Kasten (S53_) / 1.9 D	48 kW 1796 cc	01.1988-12.1992	132075	32
RENAULT	19 II (B/C53_) / 1.9 D (B/C53J)	47 kW 1870 cc	04.1992-12.1995	132075	32
RENAULT	19 II Chamade (L53_) / 1.9 D (L53J)	47 kW 1997 cc	04.1992-12.1995	132075	32
RENAULT	19 II Kasten (S53_) / 1.9 D	48 kW 1997 cc	03.1992-12.1995	132075	32
RENAULT	19 Kasten (S53_) / 1.9 D	48 kW 1870 cc	01.1988-12.1992	132075	32
RENAULT	19 Mk II (B/C53_) / 1.9 D (B/C53J)	47 kW 1870 cc	04.1992-12.1995	132075	32
RENAULT	19 Mk II Kasten (S53_) / 1.9 D	48 kW 1870 cc	03.1992-12.1995	132075	32
RENAULT	19 Mk II Stufenh. (L53_) / 1.9 D (L53J)	47 kW 1870 cc	04.1992-12.1995	132075	32
RENAULT	19 Stufenh. (L53_) / 1.9 D (L534, L53J)	47 kW 1870 cc	10.1989-04.1992	132075	32
RENAULT	20 (127_) / 2.1 D (1276)	47 kW 1905 cc	10.1980-12.1983	132051	26
RENAULT	20 (127_) / 2.1 D (1276)	47 kW 2068 cc	10.1980-12.1983	132052	27
RENAULT	20 (127_) / 2.1 TD	63 kW 1796 cc	01.1982-12.1983	132051	26
RENAULT	25 (B29_) / 2.1 D (B296)	46 kW 2188 cc	04.1984-05.1989	132051	26
RENAULT	25 (B29_) / 2.1 D (B296)	51 kW 1995 cc	06.1989-12.1992	132051	26
RENAULT	25 (B29_) / 2.1 D (B296)	51 kW 2068 cc	06.1989-12.1992	132052	27
RENAULT	25 (B29_) / 2.1 Turbo-D (B290, B29W)	63 kW 2068 cc	04.1984-12.1992	132051	26
RENAULT	30 (127_) / 2.1 Turbo-D (1270)	63 kW 2068 cc	02.1982-03.1986	132051	26
RENAULT	30 (127_) / 2.1 Turbo-D (1270)	63 kW 2068 cc	02.1982-03.1986	132052	27
RENAULT	AVANTIME (DE0_) / 2.2 dCi (DE01)	110 kW 2188 cc (G9T712)	05.2002-05.2003	132121	31
RENAULT	CLIO 1.9 D	47 kW 2499 cc	01.1991-09.1998	132075	32
RENAULT	CLIO Grandt. 1.5 dCi	76 kW 1461 cc (K9K772)	02.2008-	132121	31
RENAULT	CLIO Grandt. (KR0/1_) / 1.5 dCi	48 kW 1461 cc (K9K752)	02.2010-	132121	31
RENAULT	CLIO Grandt. (KR0/1_) / 1.5 dCi	50 kW 1461 cc (K9K768)	02.2008-	132121	31
RENAULT	CLIO Grandt. (KR0/1_) / 1.5 dCi	55 kW 2316 cc	08.2010-	132121	31
RENAULT	CLIO Grandt. (KR0/1_) / 1.5 dCi	63 kW 1461 cc (K9K766)	02.2008-	132121	31
RENAULT	CLIO Grandt. (KR0/1_) / 1.5 dCi	65 kW 1461 cc (K9K772)	08.2010-	132121	31
RENAULT	CLIO Grandt. (KR0/1_) / 1.5 dCi	78 kW 1461 cc (K9K764)	02.2008-	132121	31
RENAULT	CLIO I 1.9 D	47 kW 1870 cc	01.1991-09.1998	132075	32



Modell
Model

Motor
Engine



Baujahr
Construction year

HÜCO-NO. Seite
Page

RENAULT	CLIO II 1.5 dCi	47 kW 1461 cc (K9K740)	06.2005-	132121	31
RENAULT	CLIO II 1.5 dCi	48 kW 1461 cc (K9K700)	06.2001-	132121	31
RENAULT	CLIO II 1.5 dCi	59 kW 1461 cc (K9K702)	06.2001-10.2003	132121	31
RENAULT	CLIO II 1.5 dCi	60 kW 1461 cc (K9K702)	06.2001-	132121	31
RENAULT	CLIO II 1.5 dCi	62 kW 1461 cc (K9K718)	02.2007-	132121	31
RENAULT	CLIO II 1.9 D	47 kW 1870 cc (F8Q630)	09.1998-05.2005	132079	31
RENAULT	CLIO II 1.9 D	48 kW 1870 cc (F8Q632)	02.2000-05.2001	132074	31
RENAULT	CLIO II 1.9 dTi	59 kW 1870 cc (F9Q780)	12.1999-05.2005	132074	31
RENAULT	CLIO II (BB0/1/2_ CB0/1/2_) / 1.5 D	50 kW 1461 cc (K9K714)	08.2004-	132121	31
RENAULT	CLIO II (BB0/1/2_ CB0/1/2_) / 1.5 dCi	74 kW 1461 cc (K9K712)	01.2004-	132121	31
RENAULT	CLIO II Kasten 1.9 D	47 kW 1870 cc (F8Q662)	09.1998-	132079	31
RENAULT	CLIO II Kasten (SB0/1/2_) / 1.5 dCi	48 kW 1461 cc (K9K700)	06.2001-	132121	31
RENAULT	CLIO II Kasten (SB0/1/2_) / 1.5 dCi	50 kW 1461 cc (K9K714)	04.2004-	132121	31
RENAULT	CLIO II Kasten (SB0/1/2_) / 1.5 dCi	59 kW 1461 cc (K9K702)	06.2001-10.2004	132121	31
RENAULT	CLIO II Kasten (SB0/1/2_) / 1.5 dCi	60 kW 1461 cc (K9K702)	11.2003-	132121	31
RENAULT	CLIO II Kasten (SB0/1/2_) / 1.9 D	40 kW 1870 cc (F8Q662)	03.1999-01.2000	132079	31
RENAULT	CLIO II Kasten (SB0/1/2_) / 1.9 D	48 kW 1870 cc (F8Q632)	02.2000-05.2001	132074	31
RENAULT	CLIO II Kasten (SB0/1/2_) / 1.9 Dti	59 kW 1870 cc (F9Q780)	02.2000-05.2001	132074	31
RENAULT	CLIO III 1.5 dCi	63 kW 1461 cc (K9K766)	06.2005-	132121	31
RENAULT	CLIO III 1.5 dCi	76 kW 1461 cc (K9K772)	06.2005-	132121	31
RENAULT	CLIO III 1.5 dCi	78 kW 1461 cc (K9K764)	06.2005-	132121	31
RENAULT	CLIO III (BR0/1, CR0/1) / 1.5 D	60 kW 1461 cc (K9K750)	11.2007-	132121	31
RENAULT	CLIO III (BR0/1, CR0/1) / 1.5 dCi	48 kW 1461 cc (K9K752)	05.2005-	132121	31
RENAULT	CLIO III (BR0/1, CR0/1) / 1.5 dCi	50 kW 1461 cc (K9K768)	06.2005-	132121	31
RENAULT	CLIO Mk II / 1.5 dCi	74 kW 1461 cc	01.2004-	132121	31
RENAULT	CLIO Mk II 1.5 dCi	47 kW 1461 cc	06.2005-	132121	31
RENAULT	CLIO Mk II 1.5 dCi	48 kW 1461 cc	06.2001-	132121	31
RENAULT	CLIO Mk II 1.5 dCi	59 kW 1461 cc	06.2001-10.2003	132121	31
RENAULT	CLIO Mk II 1.5 dCi	60 kW 1461 cc	06.2001-	132121	31
RENAULT	CLIO Mk II 1.5 dCi	62 kW 1461 cc	02.2007-	132121	31
RENAULT	CLIO Mk II 1.9 D	47 kW 1870 cc	09.1998-05.2005	132079	31
RENAULT	CLIO Mk II 1.9 D	48 kW 1870 cc	02.2000-05.2001	132074	31
RENAULT	CLIO Mk II 1.9 dTi	59 kW 1870 cc	12.1999-05.2005	132074	31
RENAULT	CLIO Mk II (BB0/1/2_ CB0/1/2_) / 1.5 D	50 kW 1461 cc	08.2004-	132121	31
RENAULT	ESPACE III (JEO_) / 1.9 dTi (JEOM)	72 kW 1870 cc (F9Q722)	02.1999-10.2002	132074	31
RENAULT	ESPACE III (JEO_) / 2.2 dCi (JEOK)	95 kW 2188 cc (G9T710)	10.2000-10.2002	132121	31
RENAULT	ESPACE III (JEO_) / 2.2 dCi (JEOS)	85 kW 2188 cc (G9T710)	07.2000-10.2002	132121	31
RENAULT	ESPACE IV (JK0/1_) / 1.9 dCi	88 kW 1870 cc (F9Q820)	11.2002-	132121	31
RENAULT	ESPACE IV (JK0/1_) / 1.9 dCi (JK0U)	85 kW 1870 cc (F9Q820)	04.2003-02.2005	132121	31
RENAULT	ESPACE IV (JK0/1_) / 2.0 dCi	110 kW 1995 cc (M9R740)	01.2006-	132123	32
RENAULT	ESPACE IV (JK0/1_) / 2.2 dCi (JK07)	102 kW 2188 cc (G9T645)	02.2006-	132121	31
RENAULT	ESPACE IV (JK0/1_) / 2.2 dCi (JK0H)	110 kW 2188 cc (G9T742)	11.2002-	132121	31
RENAULT	ESPACE Mk III (JEO_) / 1.9 dTi (JEOM)	72 kW 1870 cc	02.1999-10.2002	132074	31
RENAULT	ESPACE Mk III (JEO_) / 2.2 dCi (JEOK)	95 kW 2188 cc	10.2000-10.2002	132121	31
RENAULT	ESPACE Mk III (JEO_) / 2.2 dCi (JEOS)	85 kW 2188 cc	07.2000-10.2002	132121	31
RENAULT	ESPACE Mk IV 1.9 dCi	88 kW 1870 cc	11.2002-	132121	31
RENAULT	ESPACE Mk IV 2.0 dCi	110 kW 1995 cc	01.2006-	132123	32
RENAULT	ESPACE Mk IV (JK0/1_) / 1.9 dCi (JK0U)	85 kW 1870 cc	04.2003-02.2005	132121	31
RENAULT	ESPACE Mk IV (JK0/1_) / 2.2 dCi (JK07)	102 kW 2188 cc	02.2006-	132121	31
RENAULT	ESPACE Mk IV (JK0/1_) / 2.2 dCi (JK0H)	110 kW 2188 cc	11.2002-	132121	31
RENAULT	FUEGO (136_) / 2.1 TD	65 kW 1998 cc	08.1982-10.1985	132051	26
RENAULT	FUEGO (136_) / 2.1 TD	65 kW 2068 cc	08.1982-10.1985	132052	27
RENAULT	GRAND SC NIC II 1.5 dCi	74 kW 1461 cc (K9K728)	04.2004-	132121	31
RENAULT	GRAND SC NIC II 1.9 dCi	88 kW 1870 cc (F9Q812)	04.2004-	132121	31
RENAULT	GRAND SC NIC II (JM0/1_) / 1.5 dCi (JM1E)	78 kW 1461 cc (K9K728)	05.2005-	132121	31
RENAULT	GRAND SC NIC III (JZ0/1_) / 1.9 dCi	96 kW 1870 cc (F9Q870)	02.2009-	132123	32
RENAULT	GRAND SC NIC III (JZ0/1_) / 2.0 dCi	110 kW 1995 cc (M9R615)	02.2009-	132123	32
RENAULT	KANGOO D 65	47 kW 1870 cc	08.1997-	132079	31
RENAULT	KANGOO D 65	47 kW 1870 cc (F8Q630)	08.1997-	132074	31
RENAULT	KANGOO (KC0/1_) / 1.5 dCi	42 kW 1461 cc (K9K704)	07.2003-	132121	31
RENAULT	KANGOO (KC0/1_) / 1.5 dCi	50 kW 1461 cc (K9K714)	06.2005-	132121	31
RENAULT	KANGOO (KC0/1_) / 1.5 dCi	62 kW 1461 cc (K9K718)	06.2005-	132121	31
RENAULT	KANGOO (KC0/1_) / 1.5 dCi (KC07)	48 kW 1461 cc (K9K700)	12.2001-	132121	31
RENAULT	KANGOO (KC0/1_) / 1.5 dCi (KC08,	60 kW 1461 cc (K9K702)	07.2002-	132121	31
RENAULT	KANGOO (KC0/1_) / 1.9 dCi 4x4	62 kW 1870 cc (F9Q790)	10.2003-	132121	31
RENAULT	KANGOO (KC0/1_) / 1.9 dCi 4x4 (KC0V)	59 kW 1870 cc (F9Q782)	10.2001-	132121	31
RENAULT	KANGOO (KC0/1_) / 1.9 dTi (KC0U)	59 kW 1870 cc (F9Q780)	02.2000-	132074	31



	Modell Model	Motor Engine	Baujahr Construction year	HÜCO-NO.	Seite Page
RENAULT	KANGOO (KC0/1_) / 1.9 RXED	48 kW 1870 cc (F8Q632)	09.1999-06.2001	132074	31
RENAULT	KANGOO (KC0/1_) / D 55 1.9 (KC0D)	40 kW 1870 cc (F8Q662)	08.1997-	132079	31
RENAULT	KANGOO (KC0/1_) / D 65 1.9	47 kW 1870 cc	08.1997-	132074	31
RENAULT	KANGOO (KC0/1_) / D 65 1.9	47 kW 1870 cc	08.1997-	132079	31
RENAULT	KANGOO Express 1.5 dCi	48 kW 1461 cc (K9K700)	12.2001-	132121	31
RENAULT	KANGOO Express 1.5 dCi	60 kW 1461 cc (K9K702)	04.2003-	132121	31
RENAULT	KANGOO Express 1.9 dCi 4x4	59 kW 1870 cc (F9Q782)	10.2001-	132121	31
RENAULT	KANGOO Express 1.9 dCi 4x4	62 kW 1870 cc (F9Q790)	07.2003-	132121	31
RENAULT	KANGOO Express (FC0/1_) / 1.5 dCi	42 kW 1461 cc (K9K704)	12.2002-	132121	31
RENAULT	KANGOO Express (FC0/1_) / 1.5 dCi	50 kW 1461 cc (K9K714)	06.2005-	132121	31
RENAULT	KANGOO Express (FC0/1_) / 1.5 dCi	62 kW 1461 cc (K9K718)	06.2005-	132121	31
RENAULT	KANGOO Express (FC0/1_) / 1.9 D	48 kW 1870 cc (F8Q632)	09.1999-06.2003	132074	31
RENAULT	KANGOO Express (FC0/1_) / 1.9 dCi	62 kW 1870 cc (F9Q790)	07.2003-	132121	31
RENAULT	KANGOO Express (FC0/1_) / 1.9 dTi	59 kW 1870 cc	02.2000-	132121	31
RENAULT	KANGOO Express (FC0/1_) / 1.9 dTi	59 kW 1870 cc (F9Q782)	02.2000-	132074	31
RENAULT	KANGOO Express (FC0/1_) / D 65 1.9	47 kW 1870 cc	08.1997-	132079	31
RENAULT	KANGOO Express (FC0/1_) / D 65 1.9	47 kW 1870 cc (F8Q630)	08.1997-	132074	31
RENAULT	KANGOO Express / D 55 1.9 (FC0D)	40 kW 1870 cc (F8Q662)	08.1997-	132079	31
RENAULT	KANGOO Rapid 1.5 dCi	48 kW 1461 cc	12.2001-	132121	31
RENAULT	KANGOO Rapid 1.5 dCi	60 kW 1461 cc	04.2003-	132121	31
RENAULT	KANGOO Rapid (FC0/1_) / 1.5 dCi	42 kW 1461 cc	12.2002-	132121	31
RENAULT	KANGOO Rapid (FC0/1_) / 1.5 dCi	50 kW 1461 cc	06.2005-	132121	31
RENAULT	KANGOO Rapid (FC0/1_) / 1.5 dCi	62 kW 1461 cc	06.2005-	132121	31
RENAULT	KANGOO Rapid (FC0/1_) / 1.9 D (FC0J)	48 kW 1870 cc	09.1999-06.2003	132074	31
RENAULT	KANGOO Rapid (FC0/1_) / 1.9 dCi	62 kW 1870 cc	07.2003-	132121	31
RENAULT	KANGOO Rapid (FC0/1_) / 1.9 dCi 4x4	59 kW 1870 cc	10.2001-	132121	31
RENAULT	KANGOO Rapid (FC0/1_) / 1.9 dCi 4x4	62 kW 1870 cc	07.2003-	132121	31
RENAULT	KANGOO Rapid (FC0/1_) / 1.9 dTi	59 kW 1870 cc	02.2000-	132074	31
RENAULT	KANGOO Rapid (FC0/1_) / 1.9 dTi	59 kW 1870 cc	02.2000-	132121	31
RENAULT	KANGOO Rapid (FC0/1_) / D 55 1.9 (FC0D)	40 kW 1870 cc	08.1997-	132079	31
RENAULT	KANGOO Rapid (FC0/1_) / D 65 1.9	47 kW 1870 cc	08.1997-	132074	31
RENAULT	KANGOO Rapid (FC0/1_) / D 65 1.9	47 kW 1870 cc	08.1997-	132079	31
RENAULT	LAGUNA Estate (K56_) / 1.9 dCi (K56W)	79 kW 1870 cc (F9Q718)	09.1999-03.2001	132121	31
RENAULT	LAGUNA Estate (K56_) / 1.9 dTi (K56J)	72 kW 1870 cc (F9Q710)	10.1997-03.2001	132074	31
RENAULT	LAGUNA Grandt. (K56_) / 1.9 dCi	79 kW 1870 cc	09.1999-03.2001	132121	31
RENAULT	LAGUNA Grandt. (K56_) / 1.9 dTi	72 kW 1870 cc	10.1997-03.2001	132074	31
RENAULT	LAGUNA I (B56_, 556_) / 1.9 dCi	79 kW 1870 cc (F9Q718)	09.1999-03.2001	132121	31
RENAULT	LAGUNA I (B56_, 556_) / 1.9 dTi	72 kW 1870 cc (F9Q710)	10.1997-03.2001	132074	31
RENAULT	LAGUNA I I (B56_, 556_) / 1.9 dCi	79 kW 1870 cc	09.1999-03.2001	132121	31
RENAULT	LAGUNA I I (B56_, 556_) / 1.9 dTi	72 kW 1870 cc	10.1997-03.2001	132074	31
RENAULT	LAGUNA II / 1.9 dCi (BG0E, BG0R)	74 kW 1870 cc (F9Q752)	10.2001-	132121	31
RENAULT	LAGUNA II / 1.9 dCi (BG1A, BG1W)	81 kW 1870 cc (F9Q674)	01.2005-	132121	31
RENAULT	LAGUNA II (BG0/1_) / 1.9 dCi	79 kW 1870 cc (F9Q754)	03.2001-	132121	31
RENAULT	LAGUNA II (BG0/1_) / 1.9 dCi (BG0E)	77 kW 1870 cc (F9Q752)	06.2001-	132121	31
RENAULT	LAGUNA II (BG0/1_) / 1.9 dCi (BG0G)	88 kW 1870 cc (F9Q670)	03.2001-	132121	31
RENAULT	LAGUNA II (BG0/1_) / 1.9 dCi (BG1V)	96 kW 1870 cc (F9Q758)	05.2005-	132121	31
RENAULT	LAGUNA II (BG0/1_) / 2.0 dCi (BG1S)	127 kW 1995 cc (M9R760)	01.2006-	132121	31
RENAULT	LAGUNA II (BG0/1_) / 2.0 dCi (BG1T)	110 kW 1995 cc	08.2005-	132121	31
RENAULT	LAGUNA II (BG0/1_) / 2.0 dCi (BG1T)	110 kW 1995 cc (M9R740)	08.2005-	132123	32
RENAULT	LAGUNA II (BG0/1_) / 2.2 dCi	102 kW 2188 cc (G9T600)	05.2005-	132121	31
RENAULT	LAGUNA II (BG0/1_) / 2.2 dCi (BG09)	85 kW 2188 cc (G9T600)	04.2004-10.2005	132121	31
RENAULT	LAGUNA II (BG0/1_) / 2.2 dCi (BG0F)	110 kW 2188 cc (G9T702)	10.2001-	132121	31
RENAULT	LAGUNA II Grandt. 1.9 dCi	74 kW 1870 cc (F9Q754)	10.2001-	132121	31
RENAULT	LAGUNA II Grandt. 1.9 dCi	77 kW 1870 cc (F9Q752)	06.2001-	132121	31
RENAULT	LAGUNA II Grandt. 1.9 dCi	81 kW 1870 cc (F9Q674)	01.2005-	132121	31
RENAULT	LAGUNA II Grandt. 1.9 dCi	88 kW 1870 cc (F9Q670)	03.2001-	132121	31
RENAULT	LAGUNA II Grandt. 1.9 dCi	96 kW 1870 cc (F9Q758)	05.2005-	132121	31
RENAULT	LAGUNA II Grandt. 2.0 dCi	110 kW 1995 cc	08.2005-	132121	31
RENAULT	LAGUNA II Grandt. 2.0 dCi	110 kW 1995 cc (M9R740)	08.2005-	132123	32
RENAULT	LAGUNA II Grandt. 2.0 dCi	127 kW 1995 cc (M9R760)	01.2006-	132121	31
RENAULT	LAGUNA II Grandt. 2.2 dCi	110 kW 2188 cc (G9T702)	10.2001-	132121	31
RENAULT	LAGUNA II Grandt. 2.2 dCi	85 kW 2188 cc (G9T600)	04.2004-10.2005	132121	31
RENAULT	LAGUNA II Grandt. (KG0/1_) / 1.9 dCi	79 kW 1870 cc (F9Q754)	03.2001-	132121	31
RENAULT	LAGUNA II Grandt. (KG0/1_) / 2.2 dCi	102 kW 2188 cc (G9T600)	05.2005-	132121	31
RENAULT	LAGUNA II Sport Tourer / 2.2 dCi	102 kW 2188 cc	05.2005-	132121	31
RENAULT	LAGUNA II Sport Tourer 1.9 dCi	74 kW 1870 cc	10.2001-	132121	31
RENAULT	LAGUNA II Sport Tourer 1.9 dCi	77 kW 1870 cc	06.2001-	132121	31



Modell
Model

Motor
Engine



Baujahr
Construction year

HÜCO-NO. Seite
Page

	Modell Model	Motor Engine	Baujahr Construction year	HÜCO-NO.	Seite Page
RENAULT	LAGUNA II Sport Tourer 1.9 dCi	81 kW 1870 cc	01.2005-	132121	31
RENAULT	LAGUNA II Sport Tourer 1.9 dCi	88 kW 1870 cc	03.2001-	132121	31
RENAULT	LAGUNA II Sport Tourer 1.9 dCi	96 kW 1870 cc	05.2005-	132121	31
RENAULT	LAGUNA II Sport Tourer 2.0 dCi	110 kW 1995 cc	08.2005-	132121	31
RENAULT	LAGUNA II Sport Tourer 2.0 dCi	110 kW 1995 cc	08.2005-	132123	32
RENAULT	LAGUNA II Sport Tourer 2.0 dCi	127 kW 1995 cc	01.2006-	132121	31
RENAULT	LAGUNA II Sport Tourer 2.2 dCi	110 kW 2188 cc	10.2001-	132121	31
RENAULT	LAGUNA II Sport Tourer 2.2 dCi	85 kW 2188 cc	04.2004-10.2005	132121	31
RENAULT	LAGUNA II Sport Tourer / 1.9 dCi	79 kW 1870 cc	03.2001-	132121	31
RENAULT	LAGUNA III 2.0 dCi	110 kW 1995 cc (M9R740)	10.2007-	132123	32
RENAULT	LAGUNA III Grandt. (KT0/1) / 2.0 dCi	110 kW 1995 cc (M9R740)	10.2007-	132123	32
RENAULT	LAGUNA III Sport (KT0/1) / 2.0 dCi	110 kW 1995 cc	10.2007-	132123	32
RENAULT	LAGUNA III Sportour (KT0/1) / 2.0 dCi	110 kW 1995 cc	10.2007-	132123	32
RENAULT	LAGUNA Nevada (K56_) / 1.9 dCi (K56W)	79 kW 1870 cc	09.1999-03.2001	132121	31
RENAULT	LAGUNA Nevada (K56_) / 1.9 dTi (K56J)	72 kW 1870 cc	10.1997-03.2001	132074	31
RENAULT	MASTER I Bus (T_) / 2.1 D	44 kW 2068 cc (J8S330)	11.1989-04.1995	132064	22
RENAULT	MASTER I Bus (T_) / 2.4 D	53 kW 2445 cc (S8U731)	09.1986-10.1989	132064	22
RENAULT	MASTER I Bus (T_) / 28-35 2.1 D	44 kW 2068 cc (J8S330)	08.1980-07.1998	132064	22
RENAULT	MASTER I Bus (T_) / 28-35 2.4 D	52 kW 2445 cc (S8U731)	08.1980-08.1989	132064	22
RENAULT	MASTER I Bus (T_) / 28-35 2.5 D	55 kW 2499 cc (S8U742)	08.1989-07.1998	132064	22
RENAULT	MASTER I Kasten (T_) / 2.4 D	52 kW 2445 cc (S8U730)	07.1983-08.1986	132064	22
RENAULT	MASTER I Kasten (T_) / 2.4 D	53 kW 2445 cc (S8U730)	09.1986-12.1992	132064	22
RENAULT	MASTER I Kasten (T_) / 28-35 2,5 D	55 kW 2499 cc (S8U742)	08.1989-07.1998	132064	22
RENAULT	MASTER I Kasten (T_) / 28-35 2.1 D	44 kW 2068 cc (J8S330)	08.1980-07.1998	132064	22
RENAULT	MASTER I Kasten (T_) / 28-35 2.4 D	52 kW 2445 cc (S8U731)	08.1980-08.1989	132064	22
RENAULT	MASTER I Pritsche (P_) / 2.1 D	46 kW 2068 cc (J8S330)	11.1989-07.1993	132064	22
RENAULT	MASTER I Pritsche (P_) / 2.4 D	52 kW 2445 cc (S8U730)	08.1993-02.1998	132064	22
RENAULT	MASTER I Pritsche (P_) / 2.5 D	55 kW 2499 cc (S8U742)	07.1980-10.1989	132064	22
RENAULT	MASTER I Pritsche (P_) / 28-35 2.5 D	52 kW 2445 cc (S8U731)	09.1980-07.1998	132064	22
RENAULT	MASTER I Van (T_) / 2.4 D	52 kW 2445 cc	07.1983-08.1986	132064	22
RENAULT	MASTER I Van (T_) / 2.4 D	53 kW 2445 cc	09.1986-12.1992	132064	22
RENAULT	MASTER I Van (T_) / 28-35 2,5 D	55 kW 2499 cc	08.1989-07.1998	132064	22
RENAULT	MASTER I Van (T_) / 28-35 2.1 D	44 kW 2068 cc	08.1980-07.1998	132064	22
RENAULT	MASTER I Van (T_) / 28-35 2.4 D	52 kW 2445 cc	08.1980-08.1989	132064	22
RENAULT	MASTER II Bus (JD/ND) / 1.9 dCi 80	60 kW 1870 cc (F9Q772)	11.2001-	132121	31
RENAULT	MASTER II Bus (JD/ND) / 1.9 dTi	59 kW 1870 cc (F9Q770)	09.2000-	132074	31
RENAULT	MASTER II Bus (JD/ND) / 2.2 dCi 90	66 kW 2188 cc (G9T720)	09.2000-	132121	31
RENAULT	MASTER II Bus (JD/ND) / 2.5 D	59 kW 1998 cc	07.1998-01.2001	132064	22
RENAULT	MASTER II Kasten (FD) / 1.9 dCi 80	60 kW 1870 cc (F9Q772)	11.2001-	132121	31
RENAULT	MASTER II Kasten (FD) / 1.9 dTi	59 kW 1870 cc (F9Q770)	09.2000-	132074	31
RENAULT	MASTER II Kasten (FD) / 2.2 dCi 90	66 kW 2188 cc (G9T720)	09.2000-	132121	31
RENAULT	MASTER II Kasten (FD) / 2.5 D	59 kW 1998 cc	07.1998-01.2001	132064	22
RENAULT	MASTER II Kasten (FD) / 2.5 dCi 120	84 kW 2463 cc (G9U754)	10.2001-	132122	32
RENAULT	MASTER II Pritsche (ED/HD/UD) / 2.5 D	59 kW 2499 cc	07.1998-01.2001	132064	22
RENAULT	MASTER II Pritsche / 2.2 dCi 90	66 kW 2188 cc (G9T720)	09.2000-	132121	31
RENAULT	MASTER II Pritsche 2.5 dCi 120	84 kW 2463 cc (G9U754)	10.2001-	132122	32
RENAULT	MASTER II Van (FD) / 1.9 dCi 80	60 kW 1870 cc	11.2001-	132121	31
RENAULT	MASTER II Van (FD) / 1.9 dTi	59 kW 1870 cc	09.2000-	132074	31
RENAULT	MASTER II Van (FD) / 2.2 dCi 90	66 kW 2188 cc	09.2000-	132121	31
RENAULT	MASTER II Van (FD) / 2.5 D	59 kW 2499 cc	07.1998-01.2001	132064	22
RENAULT	MASTER II Van (FD) / 2.5 dCi 120	84 kW 2463 cc	10.2001-	132122	32
RENAULT	MASTER III Bus (JD) / 2.5 dCi	107 kW 2464 cc (G9U632)	08.2006-	132122	32
RENAULT	MASTER III Bus (JD) / 2.5 dCi	74 kW 2464 cc (G9U754)	08.2006-	132122	32
RENAULT	MASTER III Bus (JD) / 2.5 dCi	88 kW 2464 cc (G9U650)	08.2006-	132122	32
RENAULT	MASTER III Bus (JD) / 2.5 dCi 100	73 kW 2463 cc (G9U754)	10.2003-	132122	32
RENAULT	MASTER III Bus (JD) / 3.0 dCi 140	100 kW 2953 cc (ZD3200)	10.2003-	132121	31
RENAULT	MASTER III Kasten / 2.5 dCi 100	73 kW 2463 cc (G9U754)	10.2003-	132122	32
RENAULT	MASTER III Kasten / 3.0 dCi 140	100 kW 2953 cc (ZD3202)	10.2003-	132121	31
RENAULT	MASTER III Kasten (HD, FD) / 2.5 dCi	107 kW 2464 cc (G9U632)	08.2006-	132122	32
RENAULT	MASTER III Kasten (HD, FD) / 2.5 dCi	74 kW 2464 cc (G9U754)	08.2006-	132122	32
RENAULT	MASTER III Kasten (HD, FD) / 2.5 dCi	88 kW 2464 cc (G9U650)	08.2006-	132122	32
RENAULT	MASTER III Pritsche 2.5 dCi 100	73 kW 2463 cc (G9U754)	10.2003-	132122	32
RENAULT	MASTER III Pritsche 3.0 dCi 140	100 kW 2953 cc (ZD3202)	10.2003-	132121	31
RENAULT	MASTER III Pritsche (ED, UD) / 2.5 dCi	107 kW 2464 cc (G9U632)	08.2006-	132122	32
RENAULT	MASTER III Pritsche (ED, UD) / 2.5 dCi	74 kW 2464 cc (G9U754)	08.2006-	132122	32
RENAULT	MASTER III Pritsche (ED, UD) / 2.5 dCi	88 kW 2464 cc (G9U650)	08.2006-	132122	32
RENAULT	MASTER IV Kasten 2.3 dCi FWD	107 kW 2299 cc (M9T698)	02.2010-	132123	32



Modell
Model

Motor
Engine



Baujahr
Construction year

HÜCO-NO. Seite
Page

RENAULT	MASTER IV Kasten 2.3 dCi FWD	74 kW 2299 cc (M9T670)	02.2010-	132123	32
RENAULT	MASTER IV Kasten 2.3 dCi FWD	92 kW 2299 cc (M9T670)	02.2010-	132123	32
RENAULT	MASTER IV Pritsche 2.3 dCi FWD	107 kW 2299 cc (M9T698)	02.2010-	132123	32
RENAULT	MASTER IV Pritsche 2.3 dCi FWD	74 kW 2299 cc (M9T670)	02.2010-	132123	32
RENAULT	MASTER IV Pritsche 2.3 dCi FWD	92 kW 2299 cc (M9T670)	02.2010-	132123	32
RENAULT	MEGANE CC / 1.9 dCi (EZOJ, EZ1S)	96 kW 1870 cc (F9Q870)	06.2010-	132123	32
RENAULT	MEGANE I (BA0/1_) / 1.9 dCi	75 kW 1870 cc (F9Q732)	02.2001-	132121	31
RENAULT	MEGANE I (BA0/1_) / 1.9 DCi	77 kW 1870 cc (F9Q732)	03.1999-07.2003	132121	31
RENAULT	MEGANE I (BA0/1_) / 1.9 dTi	72 kW 1870 cc (F9Q730)	03.1997-02.2001	132074	31
RENAULT	MEGANE I (BA0/1_) / 1.9 dTi (BA1U)	59 kW 1870 cc (F9Q744)	02.2001-	132121	31
RENAULT	MEGANE I Break 1.9 D	47 kW 1870 cc	04.1999-	132121	31
RENAULT	MEGANE I Break 1.9 D	47 kW 1870 cc (F8Q622)	04.1999-	132074	31
RENAULT	MEGANE I Break 1.9 dCi	75 kW 1870 cc (F9Q732)	02.2001-	132121	31
RENAULT	MEGANE I Break (KA0/1_) / 1.9 dTi	59 kW 1870 cc (F9Q744)	02.2001-	132121	31
RENAULT	MEGANE I Break (KA0/1_) / 1.9 dTi	72 kW 1870 cc (F9Q731)	03.1999-02.2001	132074	31
RENAULT	MEGANE I Classic 1.9 dCi	75 kW 1870 cc (F9Q732)	02.2001-	132121	31
RENAULT	MEGANE I Classic 1.9 dTi	72 kW 1870 cc (F9Q731)	03.1997-02.2001	132074	31
RENAULT	MEGANE I Classic (LA0/1_) / 1.9 dTi	59 kW 1870 cc (F9Q744)	02.2001-	132121	31
RENAULT	MEGANE I Coach 1.9 dCi	75 kW 1870 cc (F9Q732)	02.2001-08.2003	132121	31
RENAULT	MEGANE I Coach (DA0/1_) / 1.9 DCi	77 kW 1870 cc (F9Q732)	03.1999-09.2000	132121	31
RENAULT	MEGANE I Coach (DA0/1_) / 1.9 dTi	72 kW 1870 cc (F9Q731)	03.1997-02.2001	132074	31
RENAULT	MEGANE I CoupÚ 1.9 dCi	75 kW 1870 cc	02.2001-08.2003	132121	31
RENAULT	MEGANE I CoupÚ (DA0/1_) / 1.9 DCi	77 kW 1870 cc	03.1999-09.2000	132121	31
RENAULT	MEGANE I CoupÚ (DA0/1_) / 1.9 dTi	72 kW 1870 cc	03.1997-02.2001	132074	31
RENAULT	MEGANE I Grandt. 1.9 D	47 kW 1870 cc	04.1999-	132074	31
RENAULT	MEGANE I Grandt. 1.9 D	47 kW 1870 cc	04.1999-	132121	31
RENAULT	MEGANE I Grandt. 1.9 dCi	75 kW 1870 cc	02.2001-	132121	31
RENAULT	MEGANE I Grandt. 1.9 dTi	59 kW 1870 cc	02.2001-	132121	31
RENAULT	MEGANE I Grandt. 1.9 dTi	72 kW 1870 cc	03.1999-02.2001	132074	31
RENAULT	MEGANE II 1.5 dCi	60 kW 1461 cc (K9K722)	11.2002-	132121	31
RENAULT	MEGANE II (BM0/1_ CM0/1_) / 1.5 dCi	74 kW 1461 cc (K9K729)	10.2003-	132121	31
RENAULT	MEGANE II (BM0/1_ CM0/1_) / 1.5 dCi	76 kW 1461 cc (K9K728)	01.2007-	132121	31
RENAULT	MEGANE II (BM0/1_ CM0/1_) / 1.9 dCi	66 kW 1870 cc (F9Q808)	11.2002-12.2005	132121	31
RENAULT	MEGANE II (BM0/1_ CM0/1_) / 1.9 dCi	68 kW 1870 cc (F9Q808)	03.2004-	132121	31
RENAULT	MEGANE II CoupÚ-Cabriolet / 1.5 dCi	76 kW 1461 cc (K9K728)	01.2007-	132121	31
RENAULT	MEGANE II CoupÚ-Cabriolet / 1.9 dCi	88 kW 1870 cc (F9Q800)	09.2003-	132121	31
RENAULT	MEGANE II Grandt. 1.5 dCi	76 kW 1461 cc (K9K728)	01.2007-	132121	31
RENAULT	MEGANE II Grandt. (KM0/1_) / 1.5 dCi	60 kW 1461 cc (K9K722)	08.2003-	132121	31
RENAULT	MEGANE II Grandt. (KM0/1_) / 1.5 dCi	74 kW 1461 cc (K9K728)	02.2004-	132121	31
RENAULT	MEGANE II Grandt. (KM0/1_) / 1.9 dCi	66 kW 1870 cc (F9Q808)	04.2004-12.2005	132121	31
RENAULT	MEGANE II Grandt. (KM0/1_) / 1.9 dCi	68 kW 1870 cc (F9Q808)	03.2004-	132121	31
RENAULT	MEGANE II Grandt. (KM0/1_) / 1.9 dCi	88 kW 1870 cc (F9Q800)	08.2003-	132121	31
RENAULT	MEGANE II Kombi / 1.5 dCi (KM13)	76 kW 1461 cc	01.2007-	132121	31
RENAULT	MEGANE II Kombi (KM0/1_) / 1.5 dCi	60 kW 1461 cc	08.2003-	132121	31
RENAULT	MEGANE II Kombi (KM0/1_) / 1.5 dCi	74 kW 1461 cc	02.2004-	132121	31
RENAULT	MEGANE II Kombi (KM0/1_) / 1.9 dCi	66 kW 1870 cc	04.2004-12.2005	132121	31
RENAULT	MEGANE II Kombi (KM0/1_) / 1.9 dCi	68 kW 1870 cc	03.2004-	132121	31
RENAULT	MEGANE II Kombi (KM0/1_) / 1.9 dCi	88 kW 1870 cc	08.2003-	132121	31
RENAULT	MEGANE II Sport Tourer / 1.5 dCi	60 kW 1461 cc	08.2003-	132121	31
RENAULT	MEGANE II Sport Tourer / 1.5 dCi	74 kW 1461 cc	02.2004-	132121	31
RENAULT	MEGANE II Sport Tourer / 1.9 dCi	66 kW 1870 cc	04.2004-12.2005	132121	31
RENAULT	MEGANE II Sport Tourer / 1.9 dCi	68 kW 1870 cc	03.2004-	132121	31
RENAULT	MEGANE II Sport Tourer / 1.9 dCi	88 kW 1870 cc	08.2003-	132121	31
RENAULT	MEGANE II Sport Tourer 1.5 dCi	76 kW 1461 cc	01.2007-	132121	31
RENAULT	MEGANE II Stufenh. 1.9 dCi	88 kW 1870 cc (F9Q800)	09.2003-	132121	31
RENAULT	MEGANE II Stufenh. (LM0/1_) / 1.5 dCi	60 kW 1461 cc (K9K722)	09.2003-	132121	31
RENAULT	MEGANE II Stufenh. (LM0/1_) / 1.5 dCi	74 kW 1461 cc (K9K729)	02.2004-	132121	31
RENAULT	MEGANE II Stufenh. (LM0/1_) / 1.5 dCi	76 kW 1461 cc (K9K728)	01.2007-	132121	31
RENAULT	MEGANE II Stufenh. (LM0/1_) / 1.9 dCi	66 kW 1870 cc (F9Q808)	09.2003-12.2005	132121	31
RENAULT	MEGANE II Stufenh. (LM0/1_) / 1.9 dCi	68 kW 1870 cc (F9Q808)	03.2004-	132121	31
RENAULT	MEGANE III Coupe 1.5 dCi	66 kW 1461 cc (K9KH834)	11.2008-	132123	32
RENAULT	MEGANE III Coupe 1.5 dCi	81 kW 1461 cc (K9KJ836)	02.2009-	132123	32
RENAULT	MEGANE III Coupe (DZ0/1_) / 1.5 dCi	63 kW 1461 cc (K9KF830)	11.2008-	132123	32
RENAULT	MEGANE III Coupe (DZ0/1_) / 1.5 dCi	78 kW 1461 cc (K9KG832)	02.2009-	132123	32
RENAULT	MEGANE III Coupe (DZ0/1_) / 1.9 dCi	96 kW 1870 cc (F9Q872)	11.2008-	132123	32
RENAULT	MEGANE III Coupe (DZ0/1_) / 2.0 dCi	110 kW 1995 cc (M9R615)	04.2009-	132123	32
RENAULT	MEGANE III Grandt. 1.5 dCi	78 kW 1461 cc (K9KG832)	02.2009-	132123	32



Modell
Model

Motor
Engine



Baujahr
Construction year

HÜCO-NO. Seite
Page

RENAULT	MEGANE III Grandt. 1.9 dCi	96 kW 1870 cc (F9Q872)	05.2009-	132123	32
RENAULT	MEGANE III Grandt. 2.0 dCi	110 kW 1995 cc (M9R615)	10.2010-	132123	32
RENAULT	MEGANE III Schrägh. 1.5 dCi	66 kW 1461 cc (K9KH834)	11.2008-	132123	32
RENAULT	MEGANE III Schrägh. 1.9 dCi	96 kW 1870 cc (F9Q872)	11.2008-	132123	32
RENAULT	MEGANE III Schrägh. (BZ0_) / 1.5 dCi	78 kW 1461 cc (K9KG832)	02.2009-	132123	32
RENAULT	MEGANE III Schrägh. (BZ0_) / 2.0 dCi	110 kW 1995 cc (M9R615)	10.2010-	132123	32
RENAULT	MEGANE III Stufenh. / 1.9 dCi	96 kW 1870 cc (F9Q870)	06.2009-	132123	32
RENAULT	MEGANE Scenic (JA0/1_) / 1.9 dTi	72 kW 1870 cc (F9Q734)	04.1997-09.1999	132074	31
RENAULT	MODUS (F/JPO_) / 1.5 dCi (FP0D, JP0D)	60 kW 1461 cc (K9K750)	09.2005-	132121	31
RENAULT	MODUS (F/JPO_) / 1.5 dCi (FP0E, JP0E)	48 kW 1461 cc (K9K752)	12.2004-	132121	31
RENAULT	MODUS (F/JPO_) / 1.5 dCi (FP0F, JP0F)	63 kW 1461 cc (K9K766)	12.2004-	132121	31
RENAULT	MODUS (F/JPO_) / 1.5 dCi (FP0G, JP0G)	50 kW 1461 cc (K9K768)	12.2004-	132121	31
RENAULT	MODUS (F/JPO_) / 1.5 dCi (JP02)	76 kW 1461 cc (K9K772)	05.2007-	132121	31
RENAULT	MODUS (F/JPO_) / 1.5 dCi (JP0G, JP0H)	78 kW 1461 cc (K9K764)	05.2005-	132121	31
RENAULT	SAFRANE (B54_) / 2.5 dT (B548)	83 kW 2792 cc	12.1992-07.1996	132064	22
RENAULT	SAFRANE I (B54_) / 2.5 dT (B548)	83 kW 2500 cc	12.1992-07.1996	132064	22
RENAULT	SC NIC I (JA0/1_) / 1.9 dCi	75 kW 1870 cc (F9Q732)	09.1999-08.2003	132121	31
RENAULT	SC NIC I (JA0/1_) / 1.9 dTi (JA0N)	72 kW 1870 cc (F9Q734)	09.1999-08.2003	132074	31
RENAULT	SC NIC I (JA0/1_) / 1.9 dTi (JA1U)	59 kW 1870 cc (F9Q744)	02.2001-08.2003	132121	31
RENAULT	SC NIC II (JM0/1_) / 1.5 dCi	74 kW 1461 cc (K9K728)	11.2003-	132121	31
RENAULT	SC NIC II (JM0/1_) / 1.5 dCi (JM0F)	60 kW 1461 cc (K9K722)	06.2003-	132121	31
RENAULT	SC NIC II (JM0/1_) / 1.5 dCi (JM16)	76 kW 1461 cc (K9K728)	01.2007-	132121	31
RENAULT	SC NIC II (JM0/1_) / 1.5 dCi (JM1F)	63 kW 1461 cc (K9K722)	05.2005-	132121	31
RENAULT	SC NIC II (JM0/1_) / 1.9 D	85 kW 1870 cc (F9Q812)	06.2006-	132121	31
RENAULT	SC NIC II (JM0/1_) / 1.9 dCi)	88 kW 1870 cc (F9Q812)	06.2003-	132121	31
RENAULT	SC NIC III (JZ0/1_) / 1.9 dCi	96 kW 1870 cc (F9Q870)	02.2009-	132123	32
RENAULT	SC NIC III (JZ0/1_) / 2.0 dCi	110 kW 1995 cc (M9R615)	02.2009-	132123	32
RENAULT	SYMBOL (LB0/1/2_) / 1.5 dCi	47 kW 1461 cc (K9K740)	06.2005-	132121	31
RENAULT	SYMBOL (LB0/1/2_) / 1.5 dCi	48 kW 1461 cc (K9K700)	04.2002-	132121	31
RENAULT	SYMBOL (LB0/1/2_) / 1.5 dCi	50 kW 2188 cc	02.2003-	132121	31
RENAULT	SYMBOL (LB0/1/2_) / 1.5 dCi	59 kW 1461 cc (K9K702)	06.2001-10.2003	132121	31
RENAULT	SYMBOL (LB0/1/2_) / 1.5 dCi	60 kW 1461 cc (K9K702)	06.2001-	132121	31
RENAULT	SYMBOL (LB0/1/2_) / 1.9 D	48 kW 1870 cc (F8Q630)	02.1998-05.2001	132079	31
RENAULT	THALIA (LB0/1/2_) / 1.5 dCi	47 kW 1461 cc	06.2005-	132121	31
RENAULT	THALIA (LB0/1/2_) / 1.5 dCi	48 kW 1461 cc	04.2002-	132121	31
RENAULT	THALIA (LB0/1/2_) / 1.5 dCi	50 kW 1461 cc	02.2003-	132121	31
RENAULT	THALIA (LB0/1/2_) / 1.5 dCi	59 kW 1461 cc	06.2001-10.2003	132121	31
RENAULT	THALIA (LB0/1/2_) / 1.5 dCi	60 kW 1461 cc	06.2001-	132121	31
RENAULT	THALIA (LB0/1/2_) / 1.9 D	48 kW 1870 cc	02.1998-05.2001	132079	31
RENAULT	TRAFIC Bus (TXW) / 2.5 D	55 kW 2068 cc	05.1989-03.2001	132064	22
RENAULT	TRAFIC Bus (TXW) / 2.5 D 4x4	55 kW 2499 cc	08.1989-03.2001	132064	22
RENAULT	TRAFIC II Bus (JL) / 1.9 dCi	59 kW 1870 cc (F9Q762)	04.2001-07.2003	132121	31
RENAULT	TRAFIC II Bus (JL) / 1.9 dCi 100	74 kW 1870 cc (F9Q760)	03.2001-	132121	31
RENAULT	TRAFIC II Bus (JL) / 1.9 dCi 80	60 kW 1870 cc (F9Q762)	03.2001-	132121	31
RENAULT	TRAFIC II Bus (JL) / 2.0 dCi 115	84 kW 1968 cc	08.2006-	132122	32
RENAULT	TRAFIC II Kasten (FL) / 1.9 dCi	59 kW 1870 cc (F9Q762)	04.2001-07.2003	132121	31
RENAULT	TRAFIC II Kasten (FL) / 1.9 dCi 100	74 kW 1870 cc (F9Q760)	03.2001-	132121	31
RENAULT	TRAFIC II Kasten (FL) / 1.9 dCi 80	60 kW 1870 cc (F9Q762)	03.2001-	132121	31
RENAULT	TRAFIC II Kasten (FL) / 2.0 dCi 115	84 kW 1995 cc	08.2006-	132122	32
RENAULT	TRAFIC II Kasten (FL) / 2.0 dCi 90	66 kW 1995 cc	08.2006-	132122	32
RENAULT	TRAFIC II Pritsche 1.9 dCi 100	74 kW 1870 cc (F9Q760)	03.2001-	132121	31
RENAULT	TRAFIC II Pritsche 2.0 dCi 115	84 kW 1995 cc	08.2006-	132122	32
RENAULT	TRAFIC II Pritsche 2.0 dCi 90	66 kW 1995 cc	08.2006-	132122	32
RENAULT	TRAFIC II Pritsche (EL) / 1.9 dCi	59 kW 1870 cc (F9Q762)	09.2001-07.2003	132121	31
RENAULT	TRAFIC II Pritsche 1.9 dCi 80	60 kW 1870 cc (F9Q762)	03.2001-	132121	31
RENAULT	TRAFIC II Van (FL) / 1.9 dCi	59 kW 1870 cc	04.2001-07.2003	132121	31
RENAULT	TRAFIC II Van (FL) / 1.9 dCi 100	74 kW 1870 cc	03.2001-	132121	31
RENAULT	TRAFIC II Van (FL) / 1.9 dCi 80	60 kW 1870 cc	03.2001-	132121	31
RENAULT	TRAFIC II Van (FL) / 2.0 dCi 115	84 kW 1995 cc	08.2006-	132122	32
RENAULT	TRAFIC II Van (FL) / 2.0 dCi 90	66 kW 1995 cc	08.2006-	132122	32
RENAULT	TRAFIC Kasten (FL) / 1.9 dCi	59 kW 1870 cc	04.2001-07.2003	132121	31
RENAULT	TRAFIC Kasten (FL) / 1.9 dCi 100	74 kW 1870 cc	03.2001-	132121	31
RENAULT	TRAFIC Kasten (FL) / 1.9 dCi 80	60 kW 1870 cc	03.2001-	132121	31
RENAULT	TRAFIC Kasten (FL) / 2.0 dCi 115	84 kW 1995 cc	08.2006-	132122	32
RENAULT	TRAFIC Kasten (FL) / 2.0 dCi 90	66 kW 1995 cc	08.2006-	132122	32
RENAULT	TRAFIC Kasten (TXX) / 2.5 D 4x4	55 kW 2874 cc	05.1989-03.2001	132064	22
RENAULT	TRAFIC Pritsche (P6) / 2.5 D	51 kW 2998 cc	03.1980-04.1989	132064	22



Modell
Model

Motor
Engine



Baujahr
Construction year

HÜCO-NO. Seite
Page

	Modell Model	Motor Engine	Baujahr Construction year	HÜCO-NO.	Seite Page
RENAULT	TRAFIC Pritsche (PXX) / 2.5 D	51 kW 2370 cc	05.1989-03.2001	132064	22
RENAULT	TRAFIC Van (TXX) / 2.5 D 4x4	55 kW 2499 cc	05.1989-03.2001	132064	22
RENAULT	TWINGO (CN0_) / 1.5 dCi (CN0E)	47 kW 1461 cc (K9K740)	03.2007-	132121	31
RENAULT	TWINGO (CN0_) / 1.5 dCi (CN0U)	62 kW 1461 cc (K9K718)	04.2008-	132121	31
RENAULT	VEL SATIS (BJ0_) / 2.2 dCi	102 kW 2188 cc (G9T600)	09.2004-	132121	31
RENAULT	VEL SATIS (BJ0_) / 2.2 dCi	110 kW 2188 cc (G9T702)	06.2002-	132121	31
RENAULT	VEL SATIS (BJ0_) / 2.2 dCi (BJ0H)	85 kW 2188 cc (G9T600)	04.2004-	132121	31
ROVER	MAESTRO / 2.0 TD	60 kW 2461 cc	09.1990-01.1995	132057	27
ROVER	MONTEGO / 2.0 D Turbo	60 kW 2499 cc	10.1988-10.1995	132057	27
ROVER	MONTEGO Break (XE) / 2.0 Turbo-D	60 kW 1968 cc	01.1993-12.1993	132057	27
ROVER	MONTEGO Estate (XE) / 2.0 Turbo-D	60 kW 1996 cc	01.1993-12.1993	132057	27
SEAT	131 / 2.4 D	53 kW 2165 cc	06.1978-12.1986	132051	26
SEAT	131 / 2.4 D	53 kW 2445 cc	06.1978-12.1986	132052	27
SEAT	ALHAMBRA (710) / 2.0 TDI	103 kW 1968 cc	06.2010-	132129	25
SEAT	ALHAMBRA (710) / 2.0 TDI	103 kW 1968 cc (CFFB)	06.2010-	132106	24
SEAT	ALHAMBRA (710) / 2.0 TDI	125 kW 1968 cc	06.2010-	132129	25
SEAT	ALHAMBRA (710) / 2.0 TDI Allrad	103 kW 1968 cc	05.2011-	132129	25
SEAT	ALHAMBRA (710) / 2.0 TDI Allrad	103 kW 1968 cc (CFFB)	05.2011-	132106	24
SEAT	ALHAMBRA (7V8, 7V9) / 1.9 TDI	110 kW 1896 cc (ARL)	05.2005-05.2007	132105	24
SEAT	ALHAMBRA (7V8, 7V9) / 1.9 TDI	96 kW 1896 cc (ASZ)	11.2002-11.2008	132105	24
SEAT	ALHAMBRA (7V8, 7V9) / 1.9 Tdi 4x4	96 kW 1896 cc (ASZ)	06.2005-11.2008	132105	24
SEAT	ALTEA (5P1) / 1.6 TDI	66 kW 1598 cc (CAYB)	11.2010-	132106	24
SEAT	ALTEA (5P1) / 1.6 TDI	77 kW 1598 cc	10.2009-	132129	25
SEAT	ALTEA (5P1) / 1.6 TDI	77 kW 1598 cc (CAYC)	10.2009-	132106	24
SEAT	ALTEA (5P1) / 1.9 TDI	66 kW 1896 cc	08.2009-	132128	25
SEAT	ALTEA (5P1) / 1.9 TDI	66 kW 1896 cc (BXF)	08.2009-	132106	24
SEAT	ALTEA (5P1) / 1.9 TDI	77 kW 1896 cc	04.2004-	132106	24
SEAT	ALTEA (5P1) / 1.9 TDI	77 kW 1896 cc	04.2004-	132107	24
SEAT	ALTEA (5P1) / 1.9 TDI	77 kW 1896 cc	04.2004-	132128	25
SEAT	ALTEA (5P1) / 1.9 TDI	77 kW 1896 cc	04.2004-	132129	25
SEAT	ALTEA (5P1) / 1.9 TDI	77 kW 1896 cc (BKC)	04.2004-	132104	24
SEAT	ALTEA (5P1) / 2.0 TDI	100 kW 1968 cc	03.2004-05.2009	132106	24
SEAT	ALTEA (5P1) / 2.0 TDI	100 kW 1968 cc	03.2004-05.2009	132128	25
SEAT	ALTEA (5P1) / 2.0 TDI	100 kW 1968 cc	03.2004-05.2009	132129	25
SEAT	ALTEA (5P1) / 2.0 TDI	100 kW 1968 cc (AZV)	03.2004-05.2009	132104	24
SEAT	ALTEA (5P1) / 2.0 TDI	103 kW 1968 cc	11.2005-	132128	25
SEAT	ALTEA (5P1) / 2.0 TDI	103 kW 1968 cc (BMM)	11.2005-	132106	24
SEAT	ALTEA (5P1) / 2.0 TDI	125 kW 1968 cc (BMN)	03.2006-	132106	24
SEAT	ALTEA (5P1) / 2.0 TDI 16V	103 kW 1968 cc	03.2004-	132106	24
SEAT	ALTEA (5P1) / 2.0 TDI 16V	103 kW 1968 cc	03.2004-	132107	24
SEAT	ALTEA (5P1) / 2.0 TDI 16V	103 kW 1968 cc	03.2004-	132128	25
SEAT	ALTEA (5P1) / 2.0 TDI 16V	103 kW 1968 cc	03.2004-	132129	25
SEAT	ALTEA (5P1) / 2.0 TDI 16V	103 kW 1968 cc (BKD)	03.2004-	132104	24
SEAT	ALTEA XL (5P5, 5P8) / 1.6 TDI	66 kW 1598 cc (CAYB)	11.2010-	132106	24
SEAT	ALTEA XL (5P5, 5P8) / 1.6 TDI	77 kW 1598 cc	10.2009-	132129	25
SEAT	ALTEA XL (5P5, 5P8) / 1.6 TDI	77 kW 1598 cc (CAYC)	10.2009-	132106	24
SEAT	ALTEA XL (5P5, 5P8) / 1.9 TDI	66 kW 1896 cc	08.2009-	132128	25
SEAT	ALTEA XL (5P5, 5P8) / 1.9 TDI	66 kW 1896 cc (BXF)	08.2009-	132106	24
SEAT	ALTEA XL (5P5, 5P8) / 1.9 TDI	77 kW 1896 cc	10.2006-	132128	25
SEAT	ALTEA XL (5P5, 5P8) / 1.9 TDI	77 kW 1896 cc	10.2006-	132129	25
SEAT	ALTEA XL (5P5, 5P8) / 1.9 TDI	77 kW 1896 cc (BLS)	10.2006-	132106	24
SEAT	ALTEA XL (5P5, 5P8) / 2.0 TDI	100 kW 1968 cc	11.2006-03.2009	132106	24
SEAT	ALTEA XL (5P5, 5P8) / 2.0 TDI	100 kW 1968 cc	11.2006-03.2009	132128	25
SEAT	ALTEA XL (5P5, 5P8) / 2.0 TDI	100 kW 1968 cc	11.2006-03.2009	132129	25
SEAT	ALTEA XL (5P5, 5P8) / 2.0 TDI	100 kW 1968 cc (AZV)	11.2006-03.2009	132104	24
SEAT	ALTEA XL (5P5, 5P8) / 2.0 TDI	103 kW 1968 cc	10.2006-	132128	25
SEAT	ALTEA XL (5P5, 5P8) / 2.0 TDI	103 kW 1968 cc (BMM)	10.2006-	132106	24
SEAT	ALTEA XL (5P5, 5P8) / 2.0 TDI	125 kW 1968 cc (BMN)	06.2007-	132106	24
SEAT	ALTEA XL (5P5, 5P8) / 2.0 TDI 16V	103 kW 1968 cc	10.2006-	132106	24
SEAT	ALTEA XL (5P5, 5P8) / 2.0 TDI 16V	103 kW 1968 cc	10.2006-	132107	24
SEAT	ALTEA XL (5P5, 5P8) / 2.0 TDI 16V	103 kW 1968 cc	10.2006-	132128	25
SEAT	ALTEA XL (5P5, 5P8) / 2.0 TDI 16V	103 kW 1968 cc	10.2006-	132129	25
SEAT	ALTEA XL (5P5, 5P8) / 2.0 TDI 16V	103 kW 1968 cc (BKD)	10.2006-	132104	24
SEAT	ALTEA XL (5P5, 5P8) / 2.0 TDI 4x4	103 kW 1968 cc	06.2007-	132128	25
SEAT	ALTEA XL (5P5, 5P8) / 2.0 TDI 4x4	103 kW 1968 cc (BMM)	06.2007-	132106	24
SEAT	ALTEA XL (5P5, 5P8) / 2.0 TDI 4x4	125 kW 1968 cc (BMN)	06.2007-	132106	24
SEAT	AROSA (6H) / 1.4 TDI	55 kW 1422 cc (AMF)	01.2000-06.2004	132128	25



Modell
Model

Motor
Engine



Baujahr
Construction year

HÜCO-NO. Seite
Page

	Modell Model	Motor Engine	Baujahr Construction year	HÜCO-NO.	Seite Page
SEAT	CORDOBA (6K2/C2) / 1.9 TD	55 kW 1896 cc (AAZ)	02.1993-08.1996	132062	23
SEAT	CORDOBA (6L2) / 1.4 TDI	55 kW 1422 cc (AMF)	10.2002-12.2005	132128	25
SEAT	CORDOBA (6L2) / 1.4 TDI	59 kW 1422 cc (BMS)	06.2005-11.2009	132128	25
SEAT	CORDOBA (6L2) / 1.9 TDI	74 kW 1896 cc	09.2002-11.2009	132128	25
SEAT	CORDOBA (6L2) / 1.9 TDI	74 kW 1896 cc (AXR)	09.2002-11.2009	132106	24
SEAT	CORDOBA (6L2) / 1.9 TDI	96 kW 1896 cc (ASZ)	10.2002-11.2009	132105	24
SEAT	CORDOBA Stufenh. (6K2/C2) / 1.9 TD	55 kW 1896 cc	02.1993-08.1996	132062	23
SEAT	CORDOBA Stufenh. (6L2) / 1.4 TDI	55 kW 1422 cc	10.2002-12.2005	132128	25
SEAT	CORDOBA Stufenh. (6L2) / 1.4 TDI	59 kW 1422 cc	06.2005-11.2009	132128	25
SEAT	CORDOBA Stufenh. (6L2) / 1.9 TDI	74 kW 1896 cc	09.2002-11.2009	132106	24
SEAT	CORDOBA Stufenh. (6L2) / 1.9 TDI	74 kW 1896 cc	09.2002-11.2009	132128	25
SEAT	CORDOBA Stufenh. (6L2) / 1.9 TDI	96 kW 1896 cc	10.2002-11.2009	132105	24
SEAT	EXEO (3R2) / 2.0 TDI	105 kW 1968 cc (CAGA)	03.2009-	132129	25
SEAT	EXEO (3R2) / 2.0 TDI	125 kW 1968 cc (CAHA)	03.2009-	132129	25
SEAT	EXEO (3R2) / 2.0 TDI	88 kW 1968 cc (CAGC)	12.2008-	132129	25
SEAT	EXEO ST (3R5) / 2.0 TDI	105 kW 1968 cc (CAGA)	06.2009-	132129	25
SEAT	EXEO ST (3R5) / 2.0 TDI	125 kW 1968 cc (CAHA)	06.2009-	132129	25
SEAT	EXEO ST (3R5) / 2.0 TDI	88 kW 1968 cc (CAGC)	08.2009-	132129	25
SEAT	IBIZA (021A) / 1.5 i	65 kW 1796 cc	10.1986-05.1993	132040	18
SEAT	IBIZA (021A) / 1.5 i	74 kW 1968 cc	10.1986-05.1993	132040	18
SEAT	IBIZA (021A) / 1.5 i KAT	66 kW 1714 cc	10.1986-05.1993	132040	18
SEAT	IBIZA (021A) / 1.7 D	40 kW 1714 cc	06.1984-05.1993	132052	27
SEAT	IBIZA (021A) / 1.7 D	40 kW 1968 cc	06.1984-05.1993	132051	26
SEAT	IBIZA I (021A) / 1.5 i	65 kW 1461 cc	10.1986-05.1993	132040	18
SEAT	IBIZA I (021A) / 1.5 i	74 kW 1461 cc	10.1986-05.1993	132040	18
SEAT	IBIZA I (021A) / 1.5 i KAT	66 kW 1461 cc	10.1986-05.1993	132040	18
SEAT	IBIZA I (021A) / 1.7 D	40 kW 1714 cc	06.1984-05.1993	132051	26
SEAT	IBIZA I (021A) / 1.7 D	40 kW 1714 cc	06.1984-05.1993	132052	27
SEAT	IBIZA II (6K1) / 1.9 D	47 kW 1968 cc	04.1993-08.1996	132045	23
SEAT	IBIZA II (6K1) / 1.9 TD	55 kW 1896 cc (AAZ)	03.1993-08.1996	132062	23
SEAT	IBIZA IV (6L1) / 1.4 TDI	55 kW 1422 cc (AMF)	05.2002-12.2005	132128	25
SEAT	IBIZA IV (6L1) / 1.4 TDI	59 kW 1422 cc (BMS)	06.2005-11.2009	132128	25
SEAT	IBIZA IV (6L1) / 1.9 TDI	74 kW 1896 cc	02.2002-11.2009	132128	25
SEAT	IBIZA IV (6L1) / 1.9 TDI	74 kW 1896 cc (AXR)	02.2002-11.2009	132106	24
SEAT	IBIZA IV (6L1) / 1.9 TDI	96 kW 1896 cc (ASZ)	02.2002-11.2009	132105	24
SEAT	IBIZA Mk II (6K1) / 1.9 D	47 kW 1896 cc	04.1993-08.1996	132045	23
SEAT	IBIZA Mk II (6K1) / 1.9 TD	55 kW 1896 cc	03.1993-08.1996	132062	23
SEAT	IBIZA Mk IV (6L1) / 1.4 TDI	55 kW 1422 cc	05.2002-12.2005	132128	25
SEAT	IBIZA Mk IV (6L1) / 1.4 TDI	59 kW 1422 cc	06.2005-11.2009	132128	25
SEAT	IBIZA Mk IV (6L1) / 1.9 TDI	74 kW 1896 cc	02.2002-11.2009	132106	24
SEAT	IBIZA Mk IV (6L1) / 1.9 TDI	74 kW 1896 cc	02.2002-11.2009	132128	25
SEAT	IBIZA Mk IV (6L1) / 1.9 TDI	96 kW 1896 cc	02.2002-11.2009	132105	24
SEAT	IBIZA V (6J5) / 1.4 TDI	59 kW 1422 cc (BMS)	07.2008-	132128	25
SEAT	IBIZA V (6J5) / 1.6 TDI	66 kW 1598 cc (CAYB)	05.2009-	132106	24
SEAT	IBIZA V (6J5) / 1.6 TDI	77 kW 1598 cc	05.2009-	132129	25
SEAT	IBIZA V (6J5) / 1.6 TDI	77 kW 1598 cc (CAYC)	05.2009-	132106	24
SEAT	IBIZA V (6J5) / 1.9 TDI	66 kW 1896 cc	07.2008-	132128	25
SEAT	IBIZA V (6J5) / 1.9 TDI	66 kW 1896 cc (BXI)	07.2008-	132106	24
SEAT	IBIZA V (6J5) / 1.9 TDI	77 kW 1896 cc	03.2008-	132128	25
SEAT	IBIZA V (6J5) / 1.9 TDI	77 kW 1896 cc	03.2008-	132129	25
SEAT	IBIZA V (6J5) / 1.9 TDI	77 kW 1896 cc (BLS)	03.2008-	132106	24
SEAT	IBIZA V SPORTCOUPE (6J1) / 1.4 TDI	59 kW 1422 cc (BMS)	07.2008-	132128	25
SEAT	IBIZA V SPORTCOUPE (6J1) / 1.6 TDI	66 kW 1598 cc (CAYB)	05.2009-	132106	24
SEAT	IBIZA V SPORTCOUPE (6J1) / 1.6 TDI	77 kW 1598 cc	05.2009-	132129	25
SEAT	IBIZA V SPORTCOUPE (6J1) / 1.6 TDI	77 kW 1598 cc (CAYC)	05.2009-	132106	24
SEAT	IBIZA V SPORTCOUPE (6J1) / 1.9 TDI	66 kW 1896 cc	07.2008-	132128	25
SEAT	IBIZA V SPORTCOUPE (6J1) / 1.9 TDI	66 kW 1896 cc (BXI)	07.2008-	132106	24
SEAT	IBIZA V SPORTCOUPE (6J1) / 1.9 TDI	77 kW 1896 cc	07.2008-	132128	25
SEAT	IBIZA V SPORTCOUPE (6J1) / 1.9 TDI	77 kW 1896 cc	07.2008-	132129	25
SEAT	IBIZA V SPORTCOUPE (6J1) / 1.9 TDI	77 kW 1896 cc (BLS)	07.2008-	132106	24
SEAT	IBIZA V ST (6J8) / 1.6 TDI	66 kW 1598 cc (CAYB)	03.2010-	132106	24
SEAT	IBIZA V ST (6J8) / 1.6 TDI	77 kW 1598 cc	03.2010-	132129	25
SEAT	IBIZA V ST (6J8) / 1.6 TDI	77 kW 1598 cc (CAYC)	03.2010-	132106	24
SEAT	LEON (1M1) / 1.9 TDI	110 kW 1896 cc (ARL)	02.2001-06.2006	132105	24
SEAT	LEON (1M1) / 1.9 TDI	74 kW 1896 cc (AXR)	10.2005-06.2006	132128	25
SEAT	LEON (1M1) / 1.9 TDI	96 kW 1896 cc (ASZ)	05.2003-06.2006	132105	24
SEAT	LEON (1M1) / 1.9 TDI Syncro	110 kW 1896 cc (ARL)	05.2002-06.2006	132105	24



	Modell Model	Motor Engine	Baujahr Construction year	HÜCO-NO.	Seite Page
SEAT	LEON (1P1) / 1.6 TDI	66 kW 1598 cc (CAYB)	11.2010-	132106	24
SEAT	LEON (1P1) / 1.6 TDI	77 kW 1598 cc	02.2010-	132129	25
SEAT	LEON (1P1) / 1.6 TDI	77 kW 1598 cc (CAYC)	02.2010-	132106	24
SEAT	LEON (1P1) / 1.9 TDI	66 kW 1896 cc	06.2007-	132128	25
SEAT	LEON (1P1) / 1.9 TDI	66 kW 1896 cc (BXF)	06.2007-	132106	24
SEAT	LEON (1P1) / 1.9 TDI	77 kW 1896 cc	07.2005-	132106	24
SEAT	LEON (1P1) / 1.9 TDI	77 kW 1896 cc	07.2005-	132107	24
SEAT	LEON (1P1) / 1.9 TDI	77 kW 1896 cc	07.2005-	132128	25
SEAT	LEON (1P1) / 1.9 TDI	77 kW 1896 cc	07.2005-	132129	25
SEAT	LEON (1P1) / 1.9 TDI	77 kW 1896 cc (BKC)	07.2005-	132104	24
SEAT	LEON (1P1) / 2.0 TDI	100 kW 1968 cc	07.2005-05.2010	132106	24
SEAT	LEON (1P1) / 2.0 TDI	100 kW 1968 cc	07.2005-05.2010	132128	25
SEAT	LEON (1P1) / 2.0 TDI	100 kW 1968 cc	07.2005-05.2010	132129	25
SEAT	LEON (1P1) / 2.0 TDI	100 kW 1968 cc (AZV)	07.2005-05.2010	132104	24
SEAT	LEON (1P1) / 2.0 TDI	103 kW 1968 cc	10.2005-	132128	25
SEAT	LEON (1P1) / 2.0 TDI	103 kW 1968 cc (BMM)	10.2005-	132106	24
SEAT	LEON (1P1) / 2.0 TDI	125 kW 1968 cc (BMN)	05.2006-	132106	24
SEAT	LEON (1P1) / 2.0 TDI 16V	103 kW 1968 cc	07.2005-	132106	24
SEAT	LEON (1P1) / 2.0 TDI 16V	103 kW 1968 cc	07.2005-	132107	24
SEAT	LEON (1P1) / 2.0 TDI 16V	103 kW 1968 cc	07.2005-	132128	25
SEAT	LEON (1P1) / 2.0 TDI 16V	103 kW 1968 cc	07.2005-	132129	25
SEAT	LEON (1P1) / 2.0 TDI 16V	103 kW 1968 cc (BKD)	07.2005-	132104	24
SEAT	MALAGA (023A) / 1.5 i	74 kW 1870 cc	01.1987-12.1993	132040	18
SEAT	MALAGA (023A) / 1.5 i KAT	66 kW 1461 cc	10.1986-12.1993	132040	18
SEAT	MALAGA (023A) / 1.7 D	40 kW 1461 cc	05.1985-12.1993	132051	26
SEAT	MALAGA (023A) / 1.7 D	40 kW 1714 cc	05.1985-12.1993	132052	27
SEAT	MARBELLA (28) / 0.9 KAT	30 kW 1968 cc	11.1996-10.1998	132045	23
SEAT	RONDA (022A) / 1.7 D	40 kW 1714 cc	06.1982-12.1986	132052	27
SEAT	RONDA (022A) / 1.7 D	40 kW 1905 cc	06.1982-12.1986	132051	26
SEAT	RONDA (022A) / 1.7 D	41 kW 1714 cc	06.1982-12.1986	132051	26
SEAT	RONDA (022A) / 1.7 D	41 kW 1714 cc	06.1982-12.1986	132052	27
SEAT	TERRA (24) / 1.3 D	33 kW 1272 cc (MN)	03.1990-12.1994	132061	23
SEAT	TERRA Kasten (024A) / 1.3 D	33 kW 1272 cc (MN)	03.1990-02.1992	132061	23
SEAT	TOLEDO (1L) / 1.9 TD	55 kW 1896 cc (AAZ)	05.1991-03.1999	132062	23
SEAT	TOLEDO I (1L) / 1.9 TD	55 kW 1896 cc	05.1991-03.1999	132062	23
SEAT	TOLEDO II (1M2) / 1.9 TDI	110 kW 1896 cc (ARL)	10.2000-05.2006	132105	24
SEAT	TOLEDO II (1M2) / 1.9 TDi	74 kW 1896 cc (AXR)	08.2005-05.2006	132128	25
SEAT	TOLEDO II (1M2) / 1.9 TDI	96 kW 1896 cc (ASZ)	05.2003-05.2006	132105	24
SEAT	TOLEDO II Stufenh. (1M2) / 1.9 TDI	110 kW 1896 cc	10.2000-05.2006	132105	24
SEAT	TOLEDO II Stufenh. (1M2) / 1.9 TDi	74 kW 1896 cc	08.2005-05.2006	132128	25
SEAT	TOLEDO II Stufenh. (1M2) / 1.9 TDI	96 kW 1896 cc	05.2003-05.2006	132105	24
SEAT	TOLEDO III (5P2) / 1.9 TDI	77 kW 1896 cc	10.2004-05.2009	132106	24
SEAT	TOLEDO III (5P2) / 1.9 TDI	77 kW 1896 cc	10.2004-05.2009	132107	24
SEAT	TOLEDO III (5P2) / 1.9 TDI	77 kW 1896 cc	10.2004-05.2009	132128	25
SEAT	TOLEDO III (5P2) / 1.9 TDI	77 kW 1896 cc	10.2004-05.2009	132129	25
SEAT	TOLEDO III (5P2) / 1.9 TDI	77 kW 1896 cc (BKC)	10.2004-05.2009	132104	24
SEAT	TOLEDO III (5P2) / 2.0 TDI	100 kW 1968 cc	09.2004-05.2009	132106	24
SEAT	TOLEDO III (5P2) / 2.0 TDI	100 kW 1968 cc	09.2004-05.2009	132128	25
SEAT	TOLEDO III (5P2) / 2.0 TDI	100 kW 1968 cc	09.2004-05.2009	132129	25
SEAT	TOLEDO III (5P2) / 2.0 TDI	100 kW 1968 cc (AZV)	09.2004-05.2009	132104	24
SEAT	TOLEDO III (5P2) / 2.0 TDI	103 kW 1968 cc	11.2005-05.2009	132128	25
SEAT	TOLEDO III (5P2) / 2.0 TDI	103 kW 1968 cc (BMM)	11.2005-05.2009	132106	24
SEAT	TOLEDO III (5P2) / 2.0 TDI	125 kW 1968 cc (BMN)	01.2006-05.2009	132106	24
SEAT	TOLEDO III (5P2) / 2.0 TDI 16V	103 kW 1968 cc	04.2004-05.2009	132106	24
SEAT	TOLEDO III (5P2) / 2.0 TDI 16V	103 kW 1968 cc	04.2004-05.2009	132107	24
SEAT	TOLEDO III (5P2) / 2.0 TDI 16V	103 kW 1968 cc	04.2004-05.2009	132128	25
SEAT	TOLEDO III (5P2) / 2.0 TDI 16V	103 kW 1968 cc	04.2004-05.2009	132129	25
SEAT	TOLEDO III (5P2) / 2.0 TDI 16V	103 kW 1968 cc (BKD)	04.2004-05.2009	132104	24
SEAT	TOLEDO Mk II (1M2) / 1.9 TDI	110 kW 1896 cc	10.2000-05.2006	132105	24
SEAT	TOLEDO Mk II (1M2) / 1.9 TDi	74 kW 1896 cc	08.2005-05.2006	132128	25
SEAT	TOLEDO Mk II (1M2) / 1.9 TDI	96 kW 1896 cc	05.2003-05.2006	132105	24
SKODA	FABIA (6Y2) / 1.4 TDI	55 kW 1422 cc (AMF)	04.2003-03.2008	132128	25
SKODA	FABIA (6Y2) / 1.9 TDI	74 kW 1896 cc (AXR)	01.2000-03.2008	132128	25
SKODA	FABIA (6Y2) / 1.9 TDI RS	96 kW 1896 cc (ASZ)	06.2003-03.2008	132105	24
SKODA	FABIA / 1.4 TDI	59 kW 1422 cc (BMS)	01.2007-	132128	25
SKODA	FABIA / 1.6 TDI	66 kW 1598 cc (CAYB)	03.2010-	132106	24
SKODA	FABIA / 1.6 TDI	77 kW 1598 cc	03.2010-	132129	25



Modell
Model

Motor
Engine



Baujahr
Construction year

HÜCO-NO. Seite
Page

	Modell Model	Motor Engine	Baujahr Construction year	HÜCO-NO.	Seite Page
SKODA	FABIA / 1.6 TDI	77 kW 1598 cc (CAYC)	03.2010-	132106	24
SKODA	FABIA / 1.9 TDI	77 kW 1896 cc	04.2007-	132128	25
SKODA	FABIA / 1.9 TDI	77 kW 1896 cc	04.2007-	132129	25
SKODA	FABIA / 1.9 TDI	77 kW 1896 cc (BLS)	04.2007-	132106	24
SKODA	FABIA Combi (6Y5) / 1.4 TDI	55 kW 1422 cc (AMF)	04.2003-12.2007	132128	25
SKODA	FABIA Combi (6Y5) / 1.9 TDI	74 kW 1896 cc (AXR)	04.2000-12.2007	132128	25
SKODA	FABIA Combi / 1.4 TDI	59 kW 1422 cc (BMS)	10.2007-	132128	25
SKODA	FABIA Combi / 1.6 TDI	66 kW 1598 cc (CAYB)	03.2010-	132106	24
SKODA	FABIA Combi / 1.6 TDI	77 kW 1598 cc	03.2010-	132129	25
SKODA	FABIA Combi / 1.6 TDI	77 kW 1598 cc (CAYC)	03.2010-	132106	24
SKODA	FABIA Combi / 1.9 TDI	77 kW 1896 cc	10.2007-	132128	25
SKODA	FABIA Combi / 1.9 TDI	77 kW 1896 cc	10.2007-	132129	25
SKODA	FABIA Combi / 1.9 TDI	77 kW 1896 cc (BLS)	10.2007-	132106	24
SKODA	FABIA Stufenh. (6Y3) / 1.4 TDI	55 kW 1422 cc (AMF)	04.2003-12.2007	132128	25
SKODA	FABIA Stufenh. (6Y3) / 1.9 TDI	74 kW 1896 cc (AXR)	01.2000-12.2007	132128	25
SKODA	LAURA (1Z3) / 1.6 TDI	77 kW 1598 cc	06.2009-	132129	25
SKODA	LAURA (1Z3) / 1.6 TDI	77 kW 1598 cc (CAYC)	06.2009-	132106	24
SKODA	LAURA (1Z3) / 1.9 TDI	77 kW 1896 cc	06.2004-12.2010	132106	24
SKODA	LAURA (1Z3) / 1.9 TDI	77 kW 1896 cc	06.2004-12.2010	132107	24
SKODA	LAURA (1Z3) / 1.9 TDI	77 kW 1896 cc	06.2004-12.2010	132128	25
SKODA	LAURA (1Z3) / 1.9 TDI	77 kW 1896 cc	06.2004-12.2010	132129	25
SKODA	LAURA (1Z3) / 1.9 TDI	77 kW 1896 cc (BKC)	06.2004-12.2010	132104	24
SKODA	LAURA (1Z3) / 2.0 TDI	100 kW 1968 cc	02.2004-05.2010	132106	24
SKODA	LAURA (1Z3) / 2.0 TDI	100 kW 1968 cc	02.2004-05.2010	132128	25
SKODA	LAURA (1Z3) / 2.0 TDI	100 kW 1968 cc	02.2004-05.2010	132129	25
SKODA	LAURA (1Z3) / 2.0 TDI	100 kW 1968 cc (AZV)	02.2004-05.2010	132104	24
SKODA	LAURA (1Z3) / 2.0 TDI	103 kW 1968 cc	11.2005-	132128	25
SKODA	LAURA (1Z3) / 2.0 TDI	103 kW 1968 cc (BMM)	11.2005-	132106	24
SKODA	LAURA (1Z3) / 2.0 TDI	81 kW 1968 cc	03.2010-	132128	25
SKODA	LAURA (1Z3) / 2.0 TDI	81 kW 1968 cc (CLCA)	03.2010-	132106	24
SKODA	LAURA (1Z3) / 2.0 TDI 16V	103 kW 1968 cc	02.2004-	132106	24
SKODA	LAURA (1Z3) / 2.0 TDI 16V	103 kW 1968 cc	02.2004-	132107	24
SKODA	LAURA (1Z3) / 2.0 TDI 16V	103 kW 1968 cc	02.2004-	132128	25
SKODA	LAURA (1Z3) / 2.0 TDI 16V	103 kW 1968 cc	02.2004-	132129	25
SKODA	LAURA (1Z3) / 2.0 TDI 16V	103 kW 1968 cc (BKD)	02.2004-	132104	24
SKODA	LAURA (1Z3) / 2.0 TDI RS	125 kW 1968 cc (BMN)	04.2006-	132106	24
SKODA	OCTAVIA (1U2) / 1.9 TDI	74 kW 1896 cc (AXR)	10.2005-	132128	25
SKODA	OCTAVIA (1U2) / 1.9 TDI	96 kW 1896 cc (ASZ)	01.2003-	132105	24
SKODA	OCTAVIA (1Z3) / 1.6 TDI	77 kW 1598 cc	06.2009-	132106	24
SKODA	OCTAVIA (1Z3) / 1.6 TDI	77 kW 1598 cc	06.2009-	132129	25
SKODA	OCTAVIA (1Z3) / 1.9 TDI	77 kW 1896 cc	06.2004-12.2010	132104	24
SKODA	OCTAVIA (1Z3) / 1.9 TDI	77 kW 1896 cc	06.2004-12.2010	132106	24
SKODA	OCTAVIA (1Z3) / 1.9 TDI	77 kW 1896 cc	06.2004-12.2010	132107	24
SKODA	OCTAVIA (1Z3) / 1.9 TDI	77 kW 1896 cc	06.2004-12.2010	132128	25
SKODA	OCTAVIA (1Z3) / 1.9 TDI	77 kW 1896 cc	06.2004-12.2010	132129	25
SKODA	OCTAVIA (1Z3) / 2.0 TDI	100 kW 1968 cc	02.2004-05.2010	132104	24
SKODA	OCTAVIA (1Z3) / 2.0 TDI	100 kW 1968 cc	02.2004-05.2010	132106	24
SKODA	OCTAVIA (1Z3) / 2.0 TDI	100 kW 1968 cc	02.2004-05.2010	132128	25
SKODA	OCTAVIA (1Z3) / 2.0 TDI	100 kW 1968 cc	02.2004-05.2010	132129	25
SKODA	OCTAVIA (1Z3) / 2.0 TDI	103 kW 1968 cc	11.2005-	132106	24
SKODA	OCTAVIA (1Z3) / 2.0 TDI	103 kW 1968 cc	11.2005-	132128	25
SKODA	OCTAVIA (1Z3) / 2.0 TDI	81 kW 1968 cc	03.2010-	132106	24
SKODA	OCTAVIA (1Z3) / 2.0 TDI	81 kW 1968 cc	03.2010-	132128	25
SKODA	OCTAVIA (1Z3) / 2.0 TDI 16V	103 kW 1968 cc	02.2004-	132104	24
SKODA	OCTAVIA (1Z3) / 2.0 TDI 16V	103 kW 1968 cc	02.2004-	132106	24
SKODA	OCTAVIA (1Z3) / 2.0 TDI 16V	103 kW 1968 cc	02.2004-	132107	24
SKODA	OCTAVIA (1Z3) / 2.0 TDI 16V	103 kW 1968 cc	02.2004-	132128	25
SKODA	OCTAVIA (1Z3) / 2.0 TDI 16V	103 kW 1968 cc	02.2004-	132129	25
SKODA	OCTAVIA (1Z3) / 2.0 TDI RS	125 kW 1968 cc	04.2006-	132106	24
SKODA	OCTAVIA Combi (1U5) / 1.9 TDI	74 kW 1896 cc (AXR)	08.2000-	132128	25
SKODA	OCTAVIA Combi (1U5) / 1.9 TDI	96 kW 1896 cc (ASZ)	01.2003-	132105	24
SKODA	OCTAVIA Combi (1Z5) / 1.6 TDI	77 kW 1598 cc	06.2009-	132129	25
SKODA	OCTAVIA Combi (1Z5) / 1.6 TDI	77 kW 1598 cc (CAYC)	06.2009-	132106	24
SKODA	OCTAVIA Combi (1Z5) / 1.6 TDI 4x4	77 kW 1598 cc	06.2009-	132129	25
SKODA	OCTAVIA Combi (1Z5) / 1.6 TDI 4x4	77 kW 1598 cc (CAYC)	06.2009-	132106	24
SKODA	OCTAVIA Combi (1Z5) / 1.9 TDI	77 kW 1896 cc	09.2004-12.2010	132106	24
SKODA	OCTAVIA Combi (1Z5) / 1.9 TDI	77 kW 1896 cc	09.2004-12.2010	132107	24



Modell
Model

Motor
Engine



Baujahr
Construction year

HÜCO-NO. Seite
Page

	Modell Model	Motor Engine	Baujahr Construction year	HÜCO-NO.	Seite Page
SKODA	OCTAVIA Combi (1Z5) / 1.9 TDI	77 kW 1896 cc	09.2004-12.2010	132128	25
SKODA	OCTAVIA Combi (1Z5) / 1.9 TDI	77 kW 1896 cc	09.2004-12.2010	132129	25
SKODA	OCTAVIA Combi (1Z5) / 1.9 TDI	77 kW 1896 cc (BKC)	09.2004-12.2010	132104	24
SKODA	OCTAVIA Combi (1Z5) / 1.9 TDI 4x4	77 kW 1896 cc	11.2004-12.2010	132106	24
SKODA	OCTAVIA Combi (1Z5) / 1.9 TDI 4x4	77 kW 1896 cc	11.2004-12.2010	132107	24
SKODA	OCTAVIA Combi (1Z5) / 1.9 TDI 4x4	77 kW 1896 cc	11.2004-12.2010	132128	25
SKODA	OCTAVIA Combi (1Z5) / 1.9 TDI 4x4	77 kW 1896 cc	11.2004-12.2010	132129	25
SKODA	OCTAVIA Combi (1Z5) / 1.9 TDI 4x4	77 kW 1896 cc (BKC)	11.2004-12.2010	132104	24
SKODA	OCTAVIA Combi (1Z5) / 2.0 TDI	103 kW 1968 cc	11.2005-	132128	25
SKODA	OCTAVIA Combi (1Z5) / 2.0 TDI	103 kW 1968 cc (BMM)	11.2005-	132106	24
SKODA	OCTAVIA Combi (1Z5) / 2.0 TDI	81 kW 1968 cc	03.2010-	132128	25
SKODA	OCTAVIA Combi (1Z5) / 2.0 TDI	81 kW 1968 cc (CLCA)	03.2010-	132106	24
SKODA	OCTAVIA Combi (1Z5) / 2.0 TDI 16V	100 kW 1968 cc	02.2004-05.2010	132106	24
SKODA	OCTAVIA Combi (1Z5) / 2.0 TDI 16V	100 kW 1968 cc	02.2004-05.2010	132128	25
SKODA	OCTAVIA Combi (1Z5) / 2.0 TDI 16V	100 kW 1968 cc	02.2004-05.2010	132129	25
SKODA	OCTAVIA Combi (1Z5) / 2.0 TDI 16V	100 kW 1968 cc (AZV)	02.2004-05.2010	132104	24
SKODA	OCTAVIA Combi (1Z5) / 2.0 TDI 16V	103 kW 1968 cc	02.2004-	132106	24
SKODA	OCTAVIA Combi (1Z5) / 2.0 TDI 16V	103 kW 1968 cc	02.2004-	132107	24
SKODA	OCTAVIA Combi (1Z5) / 2.0 TDI 16V	103 kW 1968 cc	02.2004-	132128	25
SKODA	OCTAVIA Combi (1Z5) / 2.0 TDI 16V	103 kW 1968 cc	02.2004-	132129	25
SKODA	OCTAVIA Combi (1Z5) / 2.0 TDI 16V	103 kW 1968 cc (BKD)	02.2004-	132104	24
SKODA	OCTAVIA Combi (1Z5) / 2.0 TDI 16V 4x4	103 kW 1968 cc	05.2010-	132128	25
SKODA	OCTAVIA Combi (1Z5) / 2.0 TDI 16V 4x4	103 kW 1968 cc (CFHC)	05.2010-	132106	24
SKODA	OCTAVIA Combi (1Z5) / 2.0 TDI 4x4	103 kW 1968 cc	07.2006-	132128	25
SKODA	OCTAVIA Combi (1Z5) / 2.0 TDI 4x4	103 kW 1968 cc (BMM)	07.2006-	132106	24
SKODA	OCTAVIA Combi (1Z5) / 2.0 TDI RS	125 kW 1968 cc (BMN)	04.2006-	132106	24
SKODA	ROOMSTER (5J) / 1.4 TDI	59 kW 1422 cc (BMS)	09.2006-03.2010	132128	25
SKODA	ROOMSTER (5J) / 1.6 TDI	66 kW 1598 cc (CAYB)	03.2010-	132106	24
SKODA	ROOMSTER (5J) / 1.6 TDI	77 kW 1598 cc	03.2010-	132129	25
SKODA	ROOMSTER (5J) / 1.6 TDI	77 kW 1598 cc (CAYC)	03.2010-	132106	24
SKODA	ROOMSTER (5J) / 1.9 TDI	74 kW 1968 cc	03.2006-05.2006	132128	25
SKODA	ROOMSTER (5J) / 1.9 TDI	77 kW 1896 cc	09.2006-03.2010	132128	25
SKODA	ROOMSTER (5J) / 1.9 TDI	77 kW 1896 cc	09.2006-03.2010	132129	25
SKODA	ROOMSTER (5J) / 1.9 TDI	77 kW 1896 cc (BLS)	09.2006-03.2010	132106	24
SKODA	ROOMSTER Praktik (5J) / 1.4 TDI	59 kW 1422 cc (BMS)	03.2007-03.2010	132128	25
SKODA	ROOMSTER Praktik (5J) / 1.6 TDI	66 kW 1598 cc (CAYB)	03.2010-	132106	24
SKODA	SUPERB (3T4) / 1.6 TDI	77 kW 1598 cc	09.2010-	132129	25
SKODA	SUPERB (3T4) / 1.6 TDI	77 kW 1598 cc (CAYC)	09.2010-	132106	24
SKODA	SUPERB (3T4) / 1.9 TDI	77 kW 1896 cc	03.2008-	132128	25
SKODA	SUPERB (3T4) / 1.9 TDI	77 kW 1896 cc	03.2008-	132129	25
SKODA	SUPERB (3T4) / 1.9 TDI	77 kW 1896 cc (BLS)	03.2008-	132106	24
SKODA	SUPERB (3T4) / 2.0 TDI	103 kW 1968 cc	03.2008-	132129	25
SKODA	SUPERB (3T4) / 2.0 TDI	103 kW 1968 cc (BMP)	03.2008-	132106	24
SKODA	SUPERB (3T4) / 2.0 TDI	125 kW 1968 cc (CFGB)	07.2008-	132129	25
SKODA	SUPERB (3T4) / 2.0 TDI 16V	103 kW 1968 cc	01.2009-	132106	24
SKODA	SUPERB (3T4) / 2.0 TDI 16V	103 kW 1968 cc	01.2009-	132107	24
SKODA	SUPERB (3T4) / 2.0 TDI 16V	103 kW 1968 cc	01.2009-	132128	25
SKODA	SUPERB (3T4) / 2.0 TDI 16V	103 kW 1968 cc	01.2009-	132129	25
SKODA	SUPERB (3T4) / 2.0 TDI 16V	103 kW 1968 cc (CFFB)	01.2009-	132104	24
SKODA	SUPERB (3T4) / 2.0 TDI 16V 4x4	103 kW 1968 cc	11.2010-	132129	25
SKODA	SUPERB (3T4) / 2.0 TDI 16V 4x4	103 kW 1968 cc (CFFB)	11.2010-	132106	24
SKODA	SUPERB (3T4) / 2.0 TDI 4x4	125 kW 1968 cc (CFGB)	09.2008-	132129	25
SKODA	SUPERB (3U4) / 2.0 TDI	103 kW 1968 cc (BSS)	10.2005-03.2008	132128	25
SKODA	SUPERB Kombi (3T5) / 1.6 TDI	77 kW 1598 cc	09.2010-	132129	25
SKODA	SUPERB Kombi (3T5) / 1.6 TDI	77 kW 1598 cc (CAYC)	09.2010-	132106	24
SKODA	SUPERB Kombi (3T5) / 1.9 TDI	77 kW 1896 cc	10.2009-11.2010	132128	25
SKODA	SUPERB Kombi (3T5) / 1.9 TDI	77 kW 1896 cc	10.2009-11.2010	132129	25
SKODA	SUPERB Kombi (3T5) / 1.9 TDI	77 kW 1896 cc (BLS)	10.2009-11.2010	132106	24
SKODA	SUPERB Kombi (3T5) / 2.0 TDI	103 kW 1968 cc	10.2009-03.2010	132129	25
SKODA	SUPERB Kombi (3T5) / 2.0 TDI	103 kW 1968 cc (BMP)	10.2009-03.2010	132106	24
SKODA	SUPERB Kombi (3T5) / 2.0 TDI	125 kW 1968 cc (CFGB)	10.2009-	132129	25
SKODA	SUPERB Kombi (3T5) / 2.0 TDI 16V	103 kW 1968 cc	10.2009-	132106	24
SKODA	SUPERB Kombi (3T5) / 2.0 TDI 16V	103 kW 1968 cc	10.2009-	132107	24
SKODA	SUPERB Kombi (3T5) / 2.0 TDI 16V	103 kW 1968 cc	10.2009-	132128	25
SKODA	SUPERB Kombi (3T5) / 2.0 TDI 16V	103 kW 1968 cc	10.2009-	132129	25
SKODA	SUPERB Kombi (3T5) / 2.0 TDI 16V	103 kW 1968 cc (CFFB)	10.2009-	132104	24
SKODA	SUPERB Kombi (3T5) / 2.0 TDI 16V 4x4	103 kW 1968 cc	11.2010-	132129	25

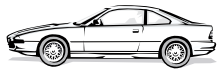

Modell
Model

Motor
Engine



Baujahr
Construction year

HÜCO-NO. Seite
Page

	Modell Model	Motor Engine	Baujahr Construction year	HÜCO-NO.	Seite Page
SKODA	SUPERB Kombi (3T5) / 2.0 TDI 16V 4x4	103 kW 1968 cc (CFFB)	11.2010-	132106	24
SKODA	SUPERB Kombi (3T5) / 2.0 TDI 4x4	125 kW 1968 cc (CFGB)	10.2009-	132129	25
SKODA	SUPERB Stufenh. (3U4) / 2.0 TDI	103 kW 1968 cc	10.2005-03.2008	132128	25
SKODA	YETI (5L) / 1.6 TDI	77 kW 1598 cc	11.2010-	132129	25
SKODA	YETI (5L) / 1.6 TDI	77 kW 1598 cc (CAYC)	11.2010-	132106	24
SKODA	YETI (5L) / 2.0 TDI	103 kW 1968 cc	11.2011-	132128	25
SKODA	YETI (5L) / 2.0 TDI	103 kW 1968 cc (CFHC)	11.2011-	132106	24
SKODA	YETI (5L) / 2.0 TDI	81 kW 1968 cc	11.2009-	132128	25
SKODA	YETI (5L) / 2.0 TDI	81 kW 1968 cc (CLCA)	11.2009-	132106	24
SKODA	YETI (5L) / 2.0 TDI 4x4	103 kW 1968 cc	05.2009-	132128	25
SKODA	YETI (5L) / 2.0 TDI 4x4	103 kW 1968 cc (CBDB)	05.2009-	132106	24
SKODA	YETI (5L) / 2.0 TDI 4x4	125 kW 1968 cc (CEGA)	11.2009-	132106	24
SKODA	YETI (5L) / 2.0 TDI 4x4	81 kW 1968 cc (CFHF)	11.2009-	132106	24
SSANGYONG	KORANDO (KJ) / 2.3 D (KJ)	58 kW 899 cc	12.1996-	132045	23
SSANGYONG	MUSSO (FJ) / 2.3 D	59 kW 2446 cc	10.1995-	132038	34
SUBARU	IMPREZA Stufenh. (GC) / 2.0 i 4WD	85 kW 1753 cc	10.1995-12.2000	132045	23
SUZUKI	BESCUDO Geländewagen / 1.9 D (ET)	55 kW 1905 cc (XUD9SD)	08.1996-03.1999	132081	28
SUZUKI	ESCUDO (ET, TA) / 1.9 D (ET)	55 kW 1905 cc (XUD9SD)	08.1996-03.1998	132081	28
SUZUKI	ESCUDO Geländewagen offen / 1.9 D (ET)	55 kW 1905 cc	08.1996-03.1999	132081	28
SUZUKI	GRAND ESCUDO (FT, GT) / 2.0 HDI 110	80 kW 1997 cc (RHZ)	07.2001-	132088	25
SUZUKI	GRAND ESCUDO (FT, GT) / 2.0 HDI 110 16V	80 kW 1997 cc (RHW)	07.2001-	132088	25
SUZUKI	GRAND VITARA	80 kW 1997 cc	07.2001-	132088	25
SUZUKI	GRAND VITARA	80 kW 1997 cc	07.2001-	132088	25
SUZUKI	GRAND VITARA (FT, GT) / 2.0 HDI 110	80 kW 1997 cc	07.2001-	132088	25
SUZUKI	GRAND VITARA (FT, GT) / 2.0 HDI 110 16V	80 kW 1997 cc	07.2001-	132088	25
SUZUKI	JIMNY (FJ) / 1.5 DDiS 4WD	48 kW 1461 cc (K9K700)	12.2003-	132121	31
SUZUKI	SAMURAI (SJ) / 1.9 TD	46 kW 1905 cc	11.1998-	132083	29
SUZUKI	SAMURAI (SJ) / 1.9 TD	46 kW 1905 cc (XUD9)	11.1998-	132080	29
SUZUKI	SIERRA (SJ) / 1.9 TD	46 kW 1905 cc	11.1998-	132080	29
SUZUKI	SIERRA (SJ) / 1.9 TD	46 kW 1905 cc	11.1998-	132083	29
SUZUKI	VITARA (ET, TA) / 1.9 D (ET)	55 kW 1905 cc	08.1996-03.1998	132081	28
SUZUKI	VITARA Cabrio (ET, TA) / 1.9 D (ET)	55 kW 1905 cc	08.1996-03.1999	132081	28
TALBOT	HORIZON / 1.9 D	47 kW 1905 cc	07.1984-06.1986	132080	29
TALBOT	HORIZON / 1.9 D	47 kW 1905 cc	07.1984-06.1986	132083	29
TALBOT	HORIZON / 1.9 D	47 kW 1905 cc (XUD9)	07.1984-06.1986	132051	26
TALBOT	HORIZON / 1.9 D	48 kW 1905 cc	07.1982-06.1986	132080	29
TALBOT	HORIZON / 1.9 D	48 kW 1905 cc	07.1982-06.1986	132083	29
TALBOT	HORIZON / 1.9 D	48 kW 1905 cc (XUD9)	07.1982-06.1986	132051	26
TALBOT	TAGORA / 2.3 Turbo D.	59 kW 3430 cc	08.1981-12.1987	132051	26
VAUXHALL	ARENA Combi / 2.5 D	55 kW 1870 cc	03.1998-08.2001	132064	22
VAUXHALL	ARENA Van / 2.5 D	55 kW 2499 cc	03.1998-08.2001	132064	22
VAUXHALL	ASTRA CC / 1.6 D	40 kW 1753 cc	03.1982-08.1986	132060	22
VAUXHALL	ASTRA CC / 1.8 GTE	85 kW 1598 cc	03.1983-08.1986	132010	15
VAUXHALL	ASTRA CC / 1.8 GTE	85 kW 1796 cc	03.1983-08.1986	132011	16
VAUXHALL	ASTRA Estate / 1.6 D	40 kW 1598 cc	02.1982-08.1986	132060	22
VAUXHALL	ASTRA Mk II Belmont / 1.6 D	40 kW 1998 cc	09.1985-08.1991	132060	22
VAUXHALL	ASTRA Mk II Belmont / 1.7 D	42 kW 1994 cc	01.1989-12.1991	132060	22
VAUXHALL	ASTRA Mk II Belmont / 1.8	82 kW 1272 cc	01.1986-12.1990	132014	16
VAUXHALL	ASTRA Mk II Belmont / 1.8 i	85 kW 1598 cc	09.1985-08.1991	132014	16
VAUXHALL	ASTRA Mk II CC / 1.6 D	40 kW 1796 cc	09.1984-12.1989	132060	22
VAUXHALL	ASTRA Mk II CC / 1.7 D	42 kW 1598 cc	01.1989-08.1991	132060	22
VAUXHALL	ASTRA Mk II CC / 1.8 GTE	82 kW 1699 cc	09.1984-08.1991	132010	15
VAUXHALL	ASTRA Mk II CC / 1.8 GTE	82 kW 1796 cc	09.1984-08.1991	132011	16
VAUXHALL	ASTRA Mk II CC / 1.8 GTE	82 kW 1796 cc	09.1984-08.1991	132014	16
VAUXHALL	ASTRA Mk II CC / 2.0 GTE	95 kW 1796 cc	09.1986-08.1991	132014	16
VAUXHALL	ASTRA Mk II CC / 2.0 GTE 16V	115 kW 1998 cc	05.1988-08.1991	132014	16
VAUXHALL	ASTRA Mk II Estate / 1.6 D	40 kW 1598 cc	09.1984-12.1989	132060	22
VAUXHALL	ASTRA Mk II Estate / 1.7 D	42 kW 2445 cc	02.1989-08.1991	132060	22
VAUXHALL	ASTRA Mk III (F) / 1.7 D	42 kW 1998 cc	03.1992-09.1992	132060	22
VAUXHALL	ASTRA Mk III (F) / 2.0 i	85 kW 1870 cc	03.1992-09.1998	132014	16
VAUXHALL	ASTRA Mk III (F) / 2.0 i 16V	100 kW 1998 cc	02.1995-09.1998	132014	16
VAUXHALL	ASTRA Mk III (F) CC / 1.7 D	42 kW 1998 cc	12.1991-02.1998	132060	22
VAUXHALL	ASTRA Mk III (F) CC / 1.7 D	44 kW 1781 cc	09.1991-12.1994	132060	22
VAUXHALL	ASTRA Mk III (F) CC / 2.0 i	85 kW 1998 cc	09.1991-02.1998	132014	16
VAUXHALL	ASTRA Mk III (F) CC / 2.0 i 16V	110 kW 1998 cc	09.1991-02.1998	132014	16
VAUXHALL	ASTRA Mk III (F) Convertible / 2.0 i	85 kW 1700 cc	03.1993-10.1994	132014	16
VAUXHALL	ASTRA Mk III (F) Estate / 1.7 D	42 kW 1699 cc	12.1991-02.1998	132060	22



Modell
Model

Motor
Engine



Baujahr
Construction year

HÜCO-NO. Seite
Page

Modell Model	Motor Engine	Baujahr Construction year	HÜCO-NO.	Seite Page
VAUXHALL ASTRA Mk III (F) Estate / 2.0 i	85 kW 1598 cc	09.1991-02.1998	132014	16
VAUXHALL BRAVA Pick-up / 2.5 D (TFR54)	56 kW 2179 cc	08.1991-06.1994	132060	22
VAUXHALL CALIBRA / 2.0 i	85 kW 1998 cc	06.1990-07.1997	132014	16
VAUXHALL CALIBRA / 2.0 i 16V	100 kW 1998 cc	06.1990-07.1997	132014	16
VAUXHALL CALIBRA / 2.0 i 16V	110 kW 1998 cc	06.1990-02.1994	132014	16
VAUXHALL CALIBRA / 2.0 i 16V 4x4	100 kW 1998 cc	02.1994-07.1997	132014	16
VAUXHALL CALIBRA / 2.0 i 16V 4x4	110 kW 1998 cc	06.1990-02.1994	132014	16
VAUXHALL CALIBRA / 2.0 i 4x4	85 kW 1998 cc	06.1990-07.1997	132014	16
VAUXHALL CALIBRA / 2.0 i 4x4	85 kW 1998 cc	06.1990-07.1997	132045	23
VAUXHALL CALIBRA / 2.0 i Turbo 4x4	150 kW 1998 cc	03.1992-07.1997	132014	16
VAUXHALL CARLTON Mk II / 2.3 D	52 kW 1598 cc	05.1983-08.1986	132060	22
VAUXHALL CARLTON Mk II Estate / 2.3 D	52 kW 2260 cc	05.1983-08.1986	132060	22
VAUXHALL CARLTON Mk III / 1.8 i	85 kW 2260 cc	09.1986-03.1994	132014	16
VAUXHALL CARLTON Mk III / 2.0 i	90 kW 1796 cc	09.1986-03.1994	132014	16
VAUXHALL CARLTON Mk III / 2.3 D	54 kW 1998 cc	09.1986-03.1994	132060	22
VAUXHALL CARLTON Mk III / 2.3 TD Interc.	74 kW 2969 cc	08.1988-03.1994	132060	22
VAUXHALL CARLTON Mk III / 2.4 i	92 kW 1598 cc	09.1988-03.1994	132014	16
VAUXHALL CARLTON Mk III / 2.6 i	110 kW 2410 cc	09.1990-03.1994	132014	16
VAUXHALL CARLTON Mk III / 3.0 3000	130 kW 2260 cc	03.1987-09.1990	132010	15
VAUXHALL CARLTON Mk III / 3.0 3000	130 kW 2969 cc	03.1987-09.1990	132011	16
VAUXHALL CARLTON Mk III / 3000	115 kW 2594 cc	03.1987-12.1987	132010	15
VAUXHALL CARLTON Mk III / 3000	115 kW 2969 cc	03.1987-12.1987	132011	16
VAUXHALL CARLTON Mk III / 3000 KAT	130 kW 2969 cc	03.1988-03.1994	132010	15
VAUXHALL CARLTON Mk III / 3000 KAT	130 kW 2969 cc	03.1988-03.1994	132011	16
VAUXHALL CARLTON Mk III Estate / 1.8 i	85 kW 2969 cc	09.1986-03.1994	132014	16
VAUXHALL CARLTON Mk III Estate / 2.0 i	73 kW 2260 cc	09.1990-03.1994	132014	16
VAUXHALL CARLTON Mk III Estate / 2.0 i	90 kW 1796 cc	09.1986-03.1994	132014	16
VAUXHALL CARLTON Mk III Estate / 2.3 D	54 kW 1998 cc	09.1986-03.1994	132060	22
VAUXHALL CARLTON Mk III Estate / 2.3 TD Interc.	74 kW 2969 cc	09.1988-03.1994	132060	22
VAUXHALL CARLTON Mk III Estate / 2.4 i	92 kW 1998 cc	09.1988-03.1994	132014	16
VAUXHALL CARLTON Mk III Estate / 2.6 i	110 kW 2410 cc	09.1990-03.1994	132014	16
VAUXHALL CARLTON Mk III Estate / 3.0	130 kW 2594 cc	03.1987-03.1994	132010	15
VAUXHALL CARLTON Mk III Estate / 3.0	130 kW 2969 cc	03.1987-03.1994	132011	16
VAUXHALL CAVALIER Mk II / 1.6 D	40 kW 2260 cc	03.1982-08.1988	132060	22
VAUXHALL CAVALIER Mk II / 1.8 i	82 kW 1598 cc	09.1981-08.1988	132010	15
VAUXHALL CAVALIER Mk II / 1.8 i	82 kW 1796 cc	09.1981-08.1988	132011	16
VAUXHALL CAVALIER Mk II / 1.8 i	82 kW 1796 cc	09.1981-08.1988	132014	16
VAUXHALL CAVALIER Mk II / 1.8 i	85 kW 1796 cc	09.1981-08.1988	132011	16
VAUXHALL CAVALIER Mk II / 1.8 i	85 kW 1796 cc	09.1981-08.1988	132014	16
VAUXHALL CAVALIER Mk II / 1.8 i	85 kW 1905 cc	09.1981-08.1988	132010	15
VAUXHALL CAVALIER Mk II / 1.8 i KAT	74 kW 1596 cc	01.1985-08.1986	132010	15
VAUXHALL CAVALIER Mk II / 1.8 i KAT	74 kW 1796 cc	01.1985-08.1986	132011	16
VAUXHALL CAVALIER Mk II / 1.8 i KAT	74 kW 1796 cc	01.1985-08.1986	132014	16
VAUXHALL CAVALIER Mk II / 2.0 i	85 kW 1796 cc	09.1986-08.1988	132014	16
VAUXHALL CAVALIER Mk II / 2.0 i KAT	85 kW 1796 cc	09.1986-08.1988	132014	16
VAUXHALL CAVALIER Mk II / 2.0 SRi 130	95 kW 1998 cc	03.1987-08.1988	132014	16
VAUXHALL CAVALIER Mk II CC / 1.8 i	82 kW 1796 cc	09.1981-08.1988	132011	16
VAUXHALL CAVALIER Mk II CC / 1.8 i	82 kW 1796 cc	09.1981-08.1988	132014	16
VAUXHALL CAVALIER Mk II CC / 1.8 i	82 kW 2998 cc	09.1981-08.1988	132010	15
VAUXHALL CAVALIER Mk II CC / 1.8 i	85 kW 1796 cc	09.1981-08.1988	132010	15
VAUXHALL CAVALIER Mk II CC / 1.8 i	85 kW 1796 cc	09.1981-08.1988	132011	16
VAUXHALL CAVALIER Mk II CC / 1.8 i	85 kW 1796 cc	09.1981-08.1988	132014	16
VAUXHALL CAVALIER Mk II CC / 1.8 i	85 kW 1796 cc	09.1981-08.1988	132045	23
VAUXHALL CAVALIER Mk II CC / 1600D	40 kW 1699 cc	03.1982-08.1988	132060	22
VAUXHALL CAVALIER Mk II CC / 2.0 i KAT	85 kW 1796 cc	09.1986-08.1988	132014	16
VAUXHALL CAVALIER Mk II Estate / 1.6 D	40 kW 1998 cc	03.1982-08.1988	132060	22
VAUXHALL CAVALIER Mk II Estate / 1.8 i	82 kW 1598 cc	09.1981-08.1986	132010	15
VAUXHALL CAVALIER Mk II Estate / 1.8 i	82 kW 1796 cc	09.1981-08.1986	132011	16
VAUXHALL CAVALIER Mk II Estate / 1.8 i	82 kW 1796 cc	09.1981-08.1986	132014	16
VAUXHALL CAVALIER Mk III (87) / 1.7 D	42 kW 1796 cc	09.1988-09.1992	132060	22
VAUXHALL CAVALIER Mk III (87) / 2.0 i	85 kW 1699 cc	09.1988-10.1990	132014	16
VAUXHALL CAVALIER Mk III (87) / 2.0 i 16V	110 kW 1998 cc	09.1988-11.1995	132014	16
VAUXHALL CAVALIER Mk III (87) / 2.0 i 16V 4x4	110 kW 1998 cc	09.1988-11.1995	132014	16
VAUXHALL CAVALIER Mk III (87) / 2.0 i 4x4	95 kW 1998 cc	09.1988-09.1992	132014	16
VAUXHALL CAVALIER Mk III (87) / 2.0 SRi	95 kW 1998 cc	09.1988-09.1992	132014	16
VAUXHALL CAVALIER Mk III CC / 1.7 D	42 kW 1998 cc	09.1988-09.1992	132060	22
VAUXHALL CAVALIER Mk III CC / 2.0 i	85 kW 1699 cc	09.1988-10.1992	132014	16



Modell
Model

Motor
Engine



Baujahr
Construction year

HÜCO-NO. Seite
Page

	Modell Model	Motor Engine	Baujahr Construction year	HÜCO-NO.	Seite Page
VAUXHALL	CAVALIER Mk III CC / 2.0 i	85 kW 1998 cc	09.1988-10.1992	132045	23
VAUXHALL	CAVALIER Mk III CC / 2.0 i 16V	110 kW 1998 cc	09.1988-11.1995	132014	16
VAUXHALL	CAVALIER Mk III CC / 2.0 SRi	95 kW 1998 cc	09.1988-09.1992	132014	16
VAUXHALL	FRONTERA Mk I (A) / 2.3 TD	74 kW 2410 cc	03.1992-10.1998	132060	22
VAUXHALL	FRONTERA Mk I (A) / 2.4 i	92 kW 1998 cc	03.1992-10.1998	132014	16
VAUXHALL	FRONTERA Mk I (A) Sport / 2.0 i	85 kW 2969 cc	03.1992-10.1998	132014	16
VAUXHALL	MOVANO Mk I (A) Combi (JD) / 1.9 DTI	59 kW 1870 cc (F9Q770)	09.2000-10.2001	132074	31
VAUXHALL	MOVANO Mk I (A) Combi (JD) / 2.2 DTI	66 kW 2188 cc (G9T720)	09.2000-	132121	31
VAUXHALL	MOVANO Mk I (A) Combi (JD) / 2.5 CDTI	74 kW 2463 cc (G9U754)	10.2001-08.2009	132122	32
VAUXHALL	MOVANO Mk I (A) Combi (JD) / 2.5 D	59 kW 1698 cc	10.1998-09.2000	132064	22
VAUXHALL	MOVANO Mk I (A) Combi (JD) / 2.5 DTI	84 kW 2463 cc (G9U754)	10.2001-08.2009	132122	32
VAUXHALL	MOVANO Mk I (A) Combi (JD) / 3.0 DTi	100 kW 2953 cc (ZD3200)	10.2003-	132121	31
VAUXHALL	MOVANO Mk I (A) Van (FD) / 1.9 DTI	59 kW 1870 cc (F9Q770)	09.2000-10.2001	132074	31
VAUXHALL	MOVANO Mk I (A) Van (FD) / 2.2 DTI	66 kW 2188 cc (G9T720)	09.2000-	132121	31
VAUXHALL	MOVANO Mk I (A) Van (FD) / 2.5 CDTI	74 kW 2463 cc (G9U754)	04.2004-	132122	32
VAUXHALL	MOVANO Mk I (A) Van (FD) / 2.5 D	88 kW 2464 cc (G9U650)	08.2006-	132122	32
VAUXHALL	MOVANO Mk I (A) Van (FD) / 2.5 CDTI	88 kW 2464 cc (G9U650)	08.2006-	132122	32
VAUXHALL	MOVANO Mk I (A) Van (FD) / 2.5 D	59 kW 2445 cc	10.1998-09.2000	132064	22
VAUXHALL	MOVANO Mk I (A) Van (FD) / 2.5 DTI	84 kW 2463 cc (G9U754)	10.2001-	132122	32
VAUXHALL	MOVANO Mk I (A) Van (FD) / 3.0 DTi	100 kW 2953 cc (ZD3202)	10.2003-	132121	31
VAUXHALL	MOVANO Mk I / 2.2 DTI	66 kW 2188 cc (G9T720)	09.2000-	132121	31
VAUXHALL	MOVANO Mk I / 2.5 CDTI	74 kW 2463 cc (G9U754)	04.2004-	132122	32
VAUXHALL	MOVANO Mk I / 2.5 CDTI	88 kW 2463 cc (G9U650)	08.2006-	132122	32
VAUXHALL	MOVANO Mk I / 2.5 D	59 kW 2499 cc	10.1998-09.2000	132064	22
VAUXHALL	MOVANO Mk I / 2.5 DTI	84 kW 2463 cc (G9U754)	10.2001-	132122	32
VAUXHALL	MOVANO Mk I / 3.0 DTi	100 kW 2953 cc (ZD3202)	10.2003-	132121	31
VAUXHALL	NOVA CC / 1.6 GSI	72 kW 1781 cc	09.1989-03.1993	132014	16
VAUXHALL	NOVA CC / 1.6 GSI	74 kW 1998 cc	05.1988-03.1992	132014	16
VAUXHALL	NOVA CC / 1.6 GSI KAT	74 kW 1598 cc	02.1992-03.1993	132014	16
VAUXHALL	ROYALE / 2.2 TD	63 kW 2260 cc	11.1984-08.1987	132060	22
VAUXHALL	SENATOR Mk II (B) / 2.6 i	110 kW 2260 cc	09.1990-09.1993	132010	15
VAUXHALL	SENATOR Mk II (B) / 2.6 i	110 kW 2594 cc	09.1990-09.1993	132011	16
VAUXHALL	SENATOR Mk II (B) / 3.0	115 kW 2594 cc	09.1987-09.1993	132010	15
VAUXHALL	SENATOR Mk II (B) / 3.0	115 kW 2969 cc	09.1987-09.1993	132011	16
VAUXHALL	SENATOR Mk II (B) / 3.0	130 kW 2969 cc	01.1988-09.1990	132010	15
VAUXHALL	SENATOR Mk II (B) / 3.0	130 kW 2969 cc	01.1988-09.1990	132011	16
VAUXHALL	SENATOR Mk II (B) / 3.0 24V	150 kW 2969 cc	09.1989-09.1993	132014	16
VAUXHALL	SENATOR Mk II (B) / 3.0 i KAT	130 kW 2969 cc	01.1988-09.1993	132010	15
VAUXHALL	SENATOR Mk II (B) / 3.0 i KAT	130 kW 2969 cc	01.1988-09.1993	132011	16
VAUXHALL	VIVARO Combi / 1.9 DTI	74 kW 1870 cc (F9Q760)	08.2001-	132121	31
VAUXHALL	VIVARO Combi / 2.5 DTI	99 kW 1796 cc	04.2004-	132121	31
VAUXHALL	VIVARO Kasten / 1.9 DTI	74 kW 1870 cc (F9Q760)	08.2001-	132121	31
VAUXHALL	VIVARO Kasten / 2.5 DTI	99 kW 2463 cc	04.2004-	132121	31
VOLVO	240 (P242, P244) / 2.4 D	58 kW 1995 cc	08.1987-08.1993	132071	30
VOLVO	240 (P242, P244) / 2.4 D	60 kW 1896 cc	08.1978-07.1985	132071	30
VOLVO	240 Break (P245) / 2.4 D	58 kW 2445 cc	08.1988-08.1993	132071	30
VOLVO	240 Break (P245) / 2.4 D	60 kW 2383 cc	04.1979-08.1993	132071	30
VOLVO	240 Kombi (P245) / 2.4 D	58 kW 2383 cc	08.1988-08.1993	132071	30
VOLVO	240 Kombi (P245) / 2.4 D	60 kW 2383 cc	04.1979-08.1993	132071	30
VOLVO	240 Stufenh. (P242, P244) / 2.4 D	58 kW 2383 cc	08.1987-08.1993	132071	30
VOLVO	240 Stufenh. (P242, P244) / 2.4 D	60 kW 2383 cc	08.1978-07.1985	132071	30
VOLVO	740 Break (745) / 2.4 TD Interc.	90 kW 2383 cc	08.1986-07.1988	132071	30
VOLVO	740 Break (745) / 2.4 Turbo-D	80 kW 2068 cc	09.1985-07.1992	132071	30
VOLVO	740 Kombi (745) / 2.4 TD Interc.	90 kW 2383 cc	08.1986-07.1988	132071	30
VOLVO	740 Kombi (745) / 2.4 Turbo-D	80 kW 2383 cc	09.1985-07.1992	132071	30
VOLVO	760 (704, 764) / 2.4 TD Interc. (704)	85 kW 2383 cc	08.1987-07.1992	132071	30
VOLVO	760 (704, 764) / 2.4 Turbo D.	80 kW 1997 cc	04.1987-07.1992	132071	30
VOLVO	760 (704, 764) / 2.4 Turbo D.	82 kW 3210 cc	08.1982-07.1987	132071	30
VOLVO	760 Break (704, 765) / 2.4 TD Interc. (765)	85 kW 1753 cc	08.1987-07.1992	132071	30
VOLVO	760 Kombi (704, 765) / 2.4 TD Interc. (765)	85 kW 2383 cc	08.1987-07.1992	132071	30
VOLVO	760 Stufenh. 2.4 TD Interc.	85 kW 2383 cc	08.1987-07.1992	132071	30
VOLVO	760 Stufenh. 2.4 Turbo D.	80 kW 2383 cc	04.1987-07.1992	132071	30
VOLVO	760 Stufenh. 2.4 Turbo D.	82 kW 2383 cc	08.1982-07.1987	132071	30
VOLVO	940 (944) / 2.4 D	60 kW 1868 cc	08.1990-12.1994	132071	30
VOLVO	940 (944) / 2.4 TD Intercooler	90 kW 1995 cc	08.1990-12.1994	132071	30
VOLVO	940 (944) / 2.4 Turbo D.	80 kW 1598 cc	08.1990-12.1994	132071	30
VOLVO	940 Break (945) / 2.4 Turbo D.	80 kW 2383 cc	08.1990-07.1994	132071	30
VOLVO	940 II (944) / 2.4 TD Interc.	90 kW 1896 cc	08.1994-10.1998	132071	30



Modell
Model

Motor
Engine



Baujahr
Construction year

HÜCO-NO. Seite
Page

VOLVO	940 II Kombi (945) / 2.4 TD Interc.	90 kW 2383 cc	08.1994-10.1998	132071	30
VOLVO	940 Kombi (945) / 2.4 Turbo D.	80 kW 2383 cc	08.1990-07.1994	132071	30
VOLVO	940 Mk II (944) / 2.4 TD Interc.	90 kW 2383 cc	08.1994-10.1998	132071	30
VOLVO	940 Mk II Kombi (945) / 2.4 TD Interc.	90 kW 2383 cc	08.1994-10.1998	132071	30
VOLVO	940 Stufenh. (944) / 2.4 D	60 kW 2383 cc	08.1990-12.1994	132071	30
VOLVO	940 Stufenh. (944) / 2.4 TD Interc	90 kW 2383 cc	08.1990-12.1994	132071	30
VOLVO	940 Stufenh. (944) / 2.4 Turbo D.	80 kW 2383 cc	08.1990-12.1994	132071	30
VOLVO	960 (964) / 2.0	103 kW 1896 cc	09.1990-08.1993	132160	37
VOLVO	960 (964) / 2.4 TD Interc.	85 kW 3430 cc	09.1991-07.1994	132071	30
VOLVO	960 Break (965) / 2.4 TD Interc.	85 kW 2383 cc	09.1991-07.1994	132071	30
VOLVO	960 Kombi (965) / 2.4 TD Interc.	85 kW 2383 cc	09.1991-07.1994	132071	30
VW	AMAROK / 2.0 TDI	90 kW 1968 cc (CDBA)	09.2010-	132106	24
VW	AMAROK / 2.0 TDI 4mot.	90 kW 1968 cc (CDBA)	09.2010-	132106	24
VW	BORA (1J2) / 1.9 TDI	110 kW 1896 cc (ARL)	05.2000-05.2005	132105	24
VW	BORA (1J2) / 1.9 TDI	74 kW 1896 cc (AXR)	09.2000-05.2005	132128	25
VW	BORA (1J2) / 1.9 TDI	96 kW 1896 cc (ASZ)	11.2000-05.2005	132105	24
VW	BORA (1J2) / 1.9 TDI 4mot.	110 kW 1896 cc (ARL)	05.2000-05.2005	132105	24
VW	BORA (1J2) / 1.9 TDI 4mot.	96 kW 1896 cc (ASZ)	11.2000-05.2005	132105	24
VW	BORA Kombi (1J6) / 1.9 TDI	110 kW 1896 cc (ARL)	05.2001-05.2005	132105	24
VW	BORA Kombi (1J6) / 1.9 TDI	74 kW 1896 cc (AXR)	09.2000-05.2005	132128	25
VW	BORA Kombi (1J6) / 1.9 TDI	96 kW 1896 cc (ASZ)	11.2000-05.2005	132105	24
VW	BORA Kombi (1J6) / 1.9 TDI 4mot.	110 kW 1896 cc (ARL)	05.2001-05.2005	132105	24
VW	BORA Kombi (1J6) / 1.9 TDI 4mot.	96 kW 1896 cc (ASZ)	11.2000-05.2005	132105	24
VW	BORA Stufenh. (1J2) / 1.9 TDI	110 kW 1896 cc	05.2000-05.2005	132105	24
VW	BORA Stufenh. (1J2) / 1.9 TDI	74 kW 1896 cc	09.2000-05.2005	132128	25
VW	BORA Stufenh. (1J2) / 1.9 TDI	96 kW 1896 cc	11.2000-05.2005	132105	24
VW	BORA Stufenh. (1J2) / 1.9 TDI 4mot.	110 kW 1896 cc	05.2000-05.2005	132105	24
VW	BORA Stufenh. (1J2) / 1.9 TDI 4mot.	96 kW 1896 cc	11.2000-05.2005	132105	24
VW	CADDY (14) / 1.6 D	40 kW 1588 cc	08.1982-07.1992	132063	23
VW	CADDY (14) / 1.6 D	40 kW 1781 cc	08.1982-07.1992	132062	23
VW	CADDY (14) / 1.8	70 kW 1781 cc	08.1985-07.1992	132023	17
VW	CADDY (14) / 1.8	70 kW 2500 cc	08.1985-07.1992	132020	16
VW	CADDY I (14) / 1.6 D	40 kW 1588 cc	08.1982-07.1992	132062	23
VW	CADDY I (14) / 1.6 D	40 kW 1588 cc	08.1982-07.1992	132063	23
VW	CADDY I (14) / 1.8	70 kW 1781 cc	08.1985-07.1992	132020	16
VW	CADDY I (14) / 1.8	70 kW 1781 cc	08.1985-07.1992	132023	17
VW	CADDY I Pick-up (14) / 1.6 D	40 kW 1588 cc	08.1982-07.1992	132062	23
VW	CADDY I Pick-up (14) / 1.6 D	40 kW 1588 cc	08.1982-07.1992	132063	23
VW	CADDY I Pick-up (14) / 1.8	70 kW 1781 cc	08.1985-07.1992	132020	16
VW	CADDY I Pick-up (14) / 1.8	70 kW 1781 cc	08.1985-07.1992	132023	17
VW	CADDY III Kasten / 1.9 TDI	55 kW 1896 cc (BSU)	09.2005-	132128	25
VW	CADDY III Kasten / 1.9 TDI	77 kW 1896 cc	04.2004-	132106	24
VW	CADDY III Kasten / 1.9 TDI	77 kW 1896 cc	04.2004-	132128	25
VW	CADDY III Kasten / 1.9 TDI	77 kW 1896 cc	04.2004-	132129	25
VW	CADDY III Kasten / 1.9 TDI	77 kW 1896 cc (BLS)	04.2004-	132104	24
VW	CADDY III Kasten / 1.9 TDI 4mot.	77 kW 1896 cc	11.2008-08.2010	132128	25
VW	CADDY III Kasten / 1.9 TDI 4mot.	77 kW 1896 cc	11.2008-08.2010	132129	25
VW	CADDY III Kasten / 1.9 TDI 4mot.	77 kW 1896 cc (BLS)	11.2008-08.2010	132106	24
VW	CADDY III Kasten / 2.0 TDI	103 kW 1968 cc	09.2007-	132128	25
VW	CADDY III Kasten / 2.0 TDI	103 kW 1968 cc (BMM)	09.2007-	132106	24
VW	CADDY III Kasten / 2.0 TDI	62 kW 1968 cc (CFHE)	11.2010-	132106	24
VW	CADDY III Kasten / 2.0 TDI 16V	103 kW 1968 cc	11.2010-	132128	25
VW	CADDY III Kasten / 2.0 TDI 16V	103 kW 1968 cc (CFHC)	11.2010-	132106	24
VW	CADDY III Kasten / 2.0 TDI 16V 4mot.	103 kW 1968 cc	11.2010-	132128	25
VW	CADDY III Kasten / 2.0 TDI 16V 4mot.	103 kW 1968 cc (CFHC)	11.2010-	132106	24
VW	CADDY III Kasten / 2.0 TDI 4mot.	62 kW 1968 cc (CFHE)	12.2010-	132106	24
VW	CADDY III Kasten / 2.0 TDI 4mot.	81 kW 1968 cc (CFHF)	10.2010-	132106	24
VW	CADDY III Kombi / 2.0 TDI 16V	103 kW 1968 cc (CFHC)	11.2010-	132106	24
VW	CADDY III Kombi 1.9 TDI 4mot.	77 kW 1896 cc	05.2008-	132128	25
VW	CADDY III Kombi 1.9 TDI 4mot.	77 kW 1896 cc	05.2008-	132129	25
VW	CADDY III Kombi 1.9 TDI 4mot.	77 kW 1896 cc (BLS)	05.2008-	132106	24
VW	CADDY III Kombi 2.0 TDI 16V 4mot.	103 kW 1968 cc	11.2010-	132128	25
VW	CADDY III Kombi 2.0 TDI 16V 4mot.	103 kW 1968 cc (CFHC)	11.2010-	132106	24
VW	CADDY III Kombi 2.0 TDI 4mot.	81 kW 1968 cc (CFHF)	10.2010-	132106	24
VW	CADDY III Kombi (2KB, 2KJ) / 1.9 TDI	55 kW 1896 cc (BSU)	09.2005-	132128	25
VW	CADDY III Kombi (2KB, 2KJ) / 1.9 TDI	77 kW 1896 cc	04.2004-	132106	24
VW	CADDY III Kombi (2KB, 2KJ) / 1.9 TDI	77 kW 1896 cc	04.2004-	132128	25



Modell
Model

Motor
Engine



Baujahr
Construction year

HÜCO-NO. Seite
Page

	Modell Model	Motor Engine	Baujahr Construction year	HÜCO-NO.	Seite Page
VW	CADDY III Kombi (2KB, 2KJ) / 1.9 TDI	77 kW 1896 cc	04.2004-	132129	25
VW	CADDY III Kombi (2KB, 2KJ) / 1.9 TDI	77 kW 1896 cc (BLS)	04.2004-	132104	24
VW	CADDY III Kombi (2KB, 2KJ) / 2.0 TDI	103 kW 1968 cc	09.2007-	132128	25
VW	CADDY III Kombi (2KB, 2KJ) / 2.0 TDI	103 kW 1968 cc (BMM)	09.2007-	132106	24
VW	CADDY III Kombi / 2.0 TDI 16V	103 kW 1968 cc	11.2010-	132128	25
VW	CARAT (32B) / 1.3	40 kW 1461 cc	08.1980-07.1983	132090	24
VW	CARAT (32B) / 1.6 D	40 kW 1588 cc	08.1980-03.1988	132063	23
VW	CARAT (32B) / 1.6 D	40 kW 1968 cc	08.1980-03.1988	132062	23
VW	CARAT (32B) / 1.6 TD	51 kW 1588 cc	04.1982-03.1988	132062	23
VW	CARAT (32B) / 1.6 TD	51 kW 1588 cc	04.1982-03.1988	132063	23
VW	CARAT (32B) / 1.6 TD	59 kW 1588 cc	05.1986-03.1988	132063	23
VW	CARAT (32B) / 1.6 TD	59 kW 1598 cc	05.1986-03.1988	132062	23
VW	CARAT Kombi (32B) / 1.6 D	40 kW 1588 cc	08.1980-03.1988	132063	23
VW	CARAT Kombi (32B) / 1.6 D	40 kW 1968 cc	08.1980-03.1988	132062	23
VW	CARAT Kombi (32B) / 1.6 TD	51 kW 1588 cc	04.1982-03.1988	132063	23
VW	CARAT Kombi (32B) / 1.6 TD	51 kW 1995 cc	04.1982-03.1988	132062	23
VW	CARAT Stufenh. (32B) / 1.6 TD	51 kW 1588 cc	01.1985-03.1988	132063	23
VW	CARAT Stufenh. (32B) / 1.6 TD	51 kW 1781 cc	01.1985-03.1988	132062	23
VW	CORSAR (32B) / 1.3	40 kW 1272 cc	08.1980-07.1983	132090	24
VW	CORSAR (32B) / 1.6 D	40 kW 1588 cc	08.1980-03.1988	132062	23
VW	CORSAR (32B) / 1.6 D	40 kW 1588 cc	08.1980-03.1988	132063	23
VW	CORSAR (32B) / 1.6 TD	51 kW 1588 cc	04.1982-03.1988	132062	23
VW	CORSAR (32B) / 1.6 TD	51 kW 1588 cc	04.1982-03.1988	132063	23
VW	CORSAR (32B) / 1.6 TD	59 kW 1588 cc	05.1986-03.1988	132062	23
VW	CORSAR (32B) / 1.6 TD	59 kW 1588 cc	05.1986-03.1988	132063	23
VW	CORSAR Kombi (32B) / 1.6 D	40 kW 1588 cc	08.1980-03.1988	132062	23
VW	CORSAR Kombi (32B) / 1.6 D	40 kW 1588 cc	08.1980-03.1988	132063	23
VW	CORSAR Kombi (32B) / 1.6 TD	51 kW 1588 cc	04.1982-03.1988	132062	23
VW	CORSAR Kombi (32B) / 1.6 TD	51 kW 1588 cc	04.1982-03.1988	132063	23
VW	CORSAR Stufenh. (32B) / 1.6 TD	51 kW 1588 cc	01.1985-03.1988	132062	23
VW	CORSAR Stufenh. (32B) / 1.6 TD	51 kW 1588 cc	01.1985-03.1988	132063	23
VW	EOS (1F7, 1F8) / 2.0 TDI	103 kW 1968 cc	06.2006-05.2008	132128	25
VW	EOS (1F7, 1F8) / 2.0 TDI	103 kW 1968 cc (BMM)	06.2006-05.2008	132106	24
VW	EOS (1F7, 1F8) / 2.0 TDI 16V	103 kW 1968 cc	05.2008-	132129	25
VW	EOS (1F7, 1F8) / 2.0 TDI 16V	103 kW 1968 cc (CBAB)	05.2008-	132106	24
VW	GOL / 1.6 Hybrid Flex	67 kW 1868 cc	09.2005-05.2008	132045	23
VW	GOLF (17) / 1.5 D	37 kW 1471 cc	08.1976-07.1980	132063	23
VW	GOLF (17) / 1.5 D	37 kW 1997 cc	08.1976-07.1980	132062	23
VW	GOLF (17) / 1.6 D	40 kW 1471 cc	08.1980-07.1983	132061	23
VW	GOLF (17) / 1.6 D	40 kW 1588 cc	08.1980-07.1983	132062	23
VW	GOLF (17) / 1.6 D	40 kW 1588 cc	08.1980-07.1983	132063	23
VW	GOLF (17) / 1.6 TD	51 kW 1588 cc	03.1982-07.1983	132061	23
VW	GOLF (17) / 1.6 TD	51 kW 1588 cc	03.1982-07.1983	132062	23
VW	GOLF (17) / 1.6 TD	51 kW 1588 cc	03.1982-07.1983	132063	23
VW	GOLF Cabriolet (155) / 1.8	66 kW 1471 cc	08.1983-09.1992	132020	16
VW	GOLF Cabriolet (155) / 1.8	66 kW 1781 cc	08.1983-09.1992	132023	17
VW	GOLF Cabriolet (155) / 1.8	70 kW 1781 cc	08.1983-04.1993	132020	16
VW	GOLF Cabriolet (155) / 1.8	70 kW 1781 cc	08.1983-04.1993	132023	17
VW	GOLF Cabriolet (155) / 1.8	72 kW 1781 cc	08.1989-03.1993	132020	16
VW	GOLF Cabriolet (155) / 1.8	72 kW 1781 cc	08.1989-03.1993	132023	17
VW	GOLF Cabriolet (155) / 1.8	82 kW 1781 cc	08.1982-12.1989	132020	16
VW	GOLF Cabriolet (155) / 1.8	82 kW 1781 cc	08.1982-12.1989	132023	17
VW	GOLF I (17) / 1.5 D	37 kW 1471 cc	08.1976-07.1980	132062	23
VW	GOLF I (17) / 1.5 D	37 kW 1471 cc	08.1976-07.1980	132063	23
VW	GOLF I (17) / 1.6 D	40 kW 1588 cc	08.1980-07.1983	132061	23
VW	GOLF I (17) / 1.6 D	40 kW 1588 cc	08.1980-07.1983	132062	23
VW	GOLF I (17) / 1.6 D	40 kW 1588 cc	08.1980-07.1983	132063	23
VW	GOLF I (17) / 1.6 TD	51 kW 1588 cc	03.1982-07.1983	132061	23
VW	GOLF I (17) / 1.6 TD	51 kW 1588 cc	03.1982-07.1983	132062	23
VW	GOLF I (17) / 1.6 TD	51 kW 1588 cc	03.1982-07.1983	132063	23
VW	GOLF I Cabriolet (155) / 1.8	66 kW 1781 cc	08.1983-09.1992	132020	16
VW	GOLF I Cabriolet (155) / 1.8	66 kW 1781 cc	08.1983-09.1992	132023	17
VW	GOLF I Cabriolet (155) / 1.8	70 kW 1781 cc	08.1983-04.1993	132020	16
VW	GOLF I Cabriolet (155) / 1.8	70 kW 1781 cc	08.1983-04.1993	132023	17
VW	GOLF I Cabriolet (155) / 1.8	72 kW 1781 cc	08.1989-03.1993	132020	16
VW	GOLF I Cabriolet (155) / 1.8	72 kW 1781 cc	08.1989-03.1993	132023	17
VW	GOLF I Cabriolet (155) / 1.8	82 kW 1781 cc	08.1982-12.1989	132020	16



Modell
Model

Motor
Engine



Baujahr
Construction year

HÜCO-NO. Seite
Page

	Modell Model	Motor Engine	Baujahr Construction year	HÜCO-NO.	Seite Page
VW	GOLF I Cabriolet (155) / 1.8	82 kW 1781 cc	08.1982-12.1989	132023	17
VW	GOLF II (19E, 1G1) / 1.3	37 kW 1588 cc	08.1985-12.1987	132045	23
VW	GOLF II (19E, 1G1) / 1.6 D	37 kW 2399 cc	08.1983-10.1991	132061	23
VW	GOLF II (19E, 1G1) / 1.6 D	40 kW 1461 cc	08.1983-10.1991	132061	23
VW	GOLF II (19E, 1G1) / 1.6 D	40 kW 1588 cc	08.1983-10.1991	132062	23
VW	GOLF II (19E, 1G1) / 1.6 D	40 kW 1588 cc	08.1983-10.1991	132063	23
VW	GOLF II (19E, 1G1) / 1.6 TD	44 kW 1589 cc	08.1989-10.1991	132062	23
VW	GOLF II (19E, 1G1) / 1.6 TD	44 kW 1589 cc	08.1989-10.1991	132063	23
VW	GOLF II (19E, 1G1) / 1.6 TD	44 kW 1997 cc	08.1989-10.1991	132061	23
VW	GOLF II (19E, 1G1) / 1.6 TD	51 kW 1588 cc	08.1983-10.1991	132062	23
VW	GOLF II (19E, 1G1) / 1.6 TD	51 kW 1588 cc	08.1983-10.1991	132063	23
VW	GOLF II (19E, 1G1) / 1.6 TD	51 kW 1870 cc	08.1983-10.1991	132061	23
VW	GOLF II (19E, 1G1) / 1.6 TD	59 kW 1588 cc	04.1989-10.1991	132062	23
VW	GOLF II (19E, 1G1) / 1.6 TD	59 kW 1588 cc	04.1989-10.1991	132063	23
VW	GOLF II (19E, 1G1) / 1.6 TD	59 kW 1588 cc (SB)	04.1989-10.1991	132061	23
VW	GOLF II (19E, 1G1) / 1.8	62 kW 2463 cc	08.1986-01.1990	132021	17
VW	GOLF II (19E, 1G1) / 1.8	66 kW 1781 cc	08.1984-10.1991	132021	17
VW	GOLF II (19E, 1G1) / 1.8 GTI	79 kW 1781 cc	08.1985-10.1987	132023	17
VW	GOLF II (19E, 1G1) / 1.8 GTI	79 kW 1998 cc	08.1985-10.1987	132020	16
VW	GOLF II (19E, 1G1) / 1.8 GTI	82 kW 1781 cc	08.1983-10.1991	132023	17
VW	GOLF II (19E, 1G1) / 1.8 GTI	82 kW 2463 cc	08.1983-10.1991	132020	16
VW	GOLF II (19E, 1G1) / 1.8 GTI KAT	79 kW 1781 cc	01.1987-10.1991	132023	17
VW	GOLF II (19E, 1G1) / 1.8 GTI KAT	79 kW 1896 cc	01.1987-10.1991	132020	16
VW	GOLF II (19E, 1G1) / 1.8 i KAT	66 kW 1870 cc	08.1987-10.1991	132021	17
VW	GOLF II (19E, 1G1) / 1.8 i Syncro KAT	66 kW 1781 cc	08.1987-10.1991	132021	17
VW	GOLF II (19E, 1G1) / 1.8 Syncro	66 kW 1870 cc	02.1986-07.1991	132021	17
VW	GOLF II (19E, 1G1) / 1.8 Syncro	72 kW 1781 cc	08.1988-07.1991	132021	17
VW	GOLF III (1H1) / 1.9 TD,GTD	55 kW 1896 cc (AAZ)	11.1991-08.1997	132062	23
VW	GOLF III Vari. (1H5) / 1.9 TD	55 kW 1896 cc (AAZ)	07.1993-04.1999	132062	23
VW	GOLF IV (1J1) / 1.9 TD	55 kW 1896 cc (AAZ)	10.1997-09.1999	132062	23
VW	GOLF IV (1J1) / 1.9 TDI	110 kW 1896 cc (ARL)	05.2000-06.2005	132105	24
VW	GOLF IV (1J1) / 1.9 TDI	74 kW 1896 cc (AXR)	09.2000-06.2005	132128	25
VW	GOLF IV (1J1) / 1.9 TDI	96 kW 1896 cc (ASZ)	11.2000-06.2005	132105	24
VW	GOLF IV (1J1) / 1.9 TDI 4mot.	110 kW 1896 cc (ARL)	02.2000-06.2005	132105	24
VW	GOLF IV (1J1) / 1.9 TDI 4mot.	96 kW 1896 cc (ASZ)	11.2000-06.2005	132105	24
VW	GOLF IV Vari. (1J5) / 1.9 TDI	74 kW 1896 cc (AXR)	09.2000-06.2006	132128	25
VW	GOLF IV Vari. (1J5) / 1.9 TDI	96 kW 1896 cc (ASZ)	11.2000-06.2006	132105	24
VW	GOLF IV Vari. (1J5) / 1.9 TDI 4mot.	96 kW 1896 cc (ASZ)	11.2000-06.2006	132105	24
VW	GOLF IV Vari. (1J5) / 1.9 TDi GTi	110 kW 1896 cc (ARL)	06.2001-06.2006	132105	24
VW	GOLF Mk II (19E, 1G1) / 1.3	37 kW 1272 cc	08.1985-12.1987	132045	23
VW	GOLF Mk II (19E, 1G1) / 1.6 D	37 kW 1588 cc	08.1983-10.1991	132061	23
VW	GOLF Mk II (19E, 1G1) / 1.6 D	40 kW 1588 cc	08.1983-10.1991	132061	23
VW	GOLF Mk II (19E, 1G1) / 1.6 D	40 kW 1588 cc	08.1983-10.1991	132062	23
VW	GOLF Mk II (19E, 1G1) / 1.6 D	40 kW 1588 cc	08.1983-10.1991	132063	23
VW	GOLF Mk II (19E, 1G1) / 1.6 TD	44 kW 1589 cc	08.1989-10.1991	132061	23
VW	GOLF Mk II (19E, 1G1) / 1.6 TD	44 kW 1589 cc	08.1989-10.1991	132062	23
VW	GOLF Mk II (19E, 1G1) / 1.6 TD	44 kW 1589 cc	08.1989-10.1991	132063	23
VW	GOLF Mk II (19E, 1G1) / 1.6 TD	51 kW 1588 cc	08.1983-10.1991	132061	23
VW	GOLF Mk II (19E, 1G1) / 1.6 TD	51 kW 1588 cc	08.1983-10.1991	132062	23
VW	GOLF Mk II (19E, 1G1) / 1.6 TD	51 kW 1588 cc	08.1983-10.1991	132063	23
VW	GOLF Mk II (19E, 1G1) / 1.6 TD	59 kW 1588 cc	04.1989-10.1991	132061	23
VW	GOLF Mk II (19E, 1G1) / 1.6 TD	59 kW 1588 cc	04.1989-10.1991	132062	23
VW	GOLF Mk II (19E, 1G1) / 1.6 TD	59 kW 1588 cc	04.1989-10.1991	132063	23
VW	GOLF Mk II (19E, 1G1) / 1.8	62 kW 1781 cc	08.1986-01.1990	132021	17
VW	GOLF Mk II (19E, 1G1) / 1.8	66 kW 1781 cc	08.1984-10.1991	132021	17
VW	GOLF Mk II (19E, 1G1) / 1.8 GTI	79 kW 1781 cc	08.1985-10.1987	132020	16
VW	GOLF Mk II (19E, 1G1) / 1.8 GTI	79 kW 1781 cc	08.1985-10.1987	132023	17
VW	GOLF Mk II (19E, 1G1) / 1.8 GTI	82 kW 1781 cc	08.1983-10.1991	132020	16
VW	GOLF Mk II (19E, 1G1) / 1.8 GTI	82 kW 1781 cc	08.1983-10.1991	132023	17
VW	GOLF Mk II (19E, 1G1) / 1.8 GTI KAT	79 kW 1781 cc	01.1987-10.1991	132020	16
VW	GOLF Mk II (19E, 1G1) / 1.8 GTI KAT	79 kW 1781 cc	01.1987-10.1991	132023	17
VW	GOLF Mk II (19E, 1G1) / 1.8 i KAT	66 kW 1781 cc	08.1987-10.1991	132021	17
VW	GOLF Mk II (19E, 1G1) / 1.8 i Syncro KAT	66 kW 1781 cc	08.1987-10.1991	132021	17
VW	GOLF Mk II (19E, 1G1) / 1.8 Syncro	66 kW 1781 cc	02.1986-07.1991	132021	17
VW	GOLF Mk II (19E, 1G1) / 1.8 Syncro	72 kW 1781 cc	08.1988-07.1991	132021	17
VW	GOLF Mk III (1H1) / 1.9 TD,GTD	55 kW 1896 cc	11.1991-08.1997	132062	23
VW	GOLF Mk III Estate (1H5) / 1.9 TD	55 kW 1896 cc	07.1993-04.1999	132062	23



Modell
Model

Motor
Engine



Baujahr
Construction year

HÜCO-NO. Seite
Page

	Modell Model	Motor Engine	Baujahr Construction year	HÜCO-NO.	Seite Page
VW	GOLF Mk IV (1J1) / 1.9 TD	55 kW 1896 cc	10.1997-09.1999	132062	23
VW	GOLF Mk IV (1J1) / 1.9 TDI	110 kW 1896 cc	05.2000-06.2005	132105	24
VW	GOLF Mk IV (1J1) / 1.9 TDI	74 kW 1896 cc	09.2000-06.2005	132128	25
VW	GOLF Mk IV (1J1) / 1.9 TDI	96 kW 1896 cc	11.2000-06.2005	132105	24
VW	GOLF Mk IV (1J1) / 1.9 TDI 4mot.	110 kW 1896 cc	02.2000-06.2005	132105	24
VW	GOLF Mk IV (1J1) / 1.9 TDI 4mot.	96 kW 1896 cc	11.2000-06.2005	132105	24
VW	GOLF Mk IV Estate (1J5) / 1.9 TDI	74 kW 1896 cc	09.2000-06.2006	132128	25
VW	GOLF Mk IV Estate (1J5) / 1.9 TDI	96 kW 1896 cc	11.2000-06.2006	132105	24
VW	GOLF Mk IV Estate (1J5) / 1.9 TDI 4mot.	96 kW 1896 cc	11.2000-06.2006	132105	24
VW	GOLF Mk IV Estate (1J5) / 1.9 TDI GTi	110 kW 1896 cc	06.2001-06.2006	132105	24
VW	GOLF PLUS (5M1, 521) / 1.6 TDI	66 kW 1598 cc (CAYB)	02.2009-	132106	24
VW	GOLF PLUS (5M1, 521) / 1.6 TDI	77 kW 1598 cc	03.2009-	132129	25
VW	GOLF PLUS (5M1, 521) / 1.6 TDI	77 kW 1598 cc (CAYC)	03.2009-	132106	24
VW	GOLF PLUS (5M1, 521) / 1.9 TDI	66 kW 1896 cc	05.2005-12.2008	132128	25
VW	GOLF PLUS (5M1, 521) / 1.9 TDI	66 kW 1896 cc (BRU)	05.2005-12.2008	132106	24
VW	GOLF PLUS (5M1, 521) / 1.9 TDI	77 kW 1896 cc	01.2005-01.2009	132106	24
VW	GOLF PLUS (5M1, 521) / 1.9 TDI	77 kW 1896 cc	01.2005-01.2009	132107	24
VW	GOLF PLUS (5M1, 521) / 1.9 TDI	77 kW 1896 cc	01.2005-01.2009	132128	25
VW	GOLF PLUS (5M1, 521) / 1.9 TDI	77 kW 1896 cc	01.2005-01.2009	132129	25
VW	GOLF PLUS (5M1, 521) / 1.9 TDI	77 kW 1896 cc (BKC)	01.2005-01.2009	132104	24
VW	GOLF PLUS (5M1, 521) / 2.0 TDI	100 kW 1968 cc	05.2005-	132106	24
VW	GOLF PLUS (5M1, 521) / 2.0 TDI	100 kW 1968 cc	05.2005-	132128	25
VW	GOLF PLUS (5M1, 521) / 2.0 TDI	100 kW 1968 cc	05.2005-	132129	25
VW	GOLF PLUS (5M1, 521) / 2.0 TDI	100 kW 1968 cc (AZV)	05.2005-	132104	24
VW	GOLF PLUS (5M1, 521) / 2.0 TDI	103 kW 1968 cc	12.2005-05.2009	132128	25
VW	GOLF PLUS (5M1, 521) / 2.0 TDI	103 kW 1968 cc (BMM)	12.2005-05.2009	132106	24
VW	GOLF PLUS (5M1, 521) / 2.0 TDI	81 kW 1968 cc	01.2009-	132129	25
VW	GOLF PLUS (5M1, 521) / 2.0 TDI	81 kW 1968 cc (CBDC)	01.2009-	132128	25
VW	GOLF PLUS (5M1, 521) / 2.0 TDI 16V	103 kW 1968 cc	01.2005-	132106	24
VW	GOLF PLUS (5M1, 521) / 2.0 TDI 16V	103 kW 1968 cc	01.2005-	132107	24
VW	GOLF PLUS (5M1, 521) / 2.0 TDI 16V	103 kW 1968 cc	01.2005-	132128	25
VW	GOLF PLUS (5M1, 521) / 2.0 TDI 16V	103 kW 1968 cc	01.2005-	132129	25
VW	GOLF PLUS (5M1, 521) / 2.0 TDI 16V	103 kW 1968 cc (BKD)	01.2005-	132104	24
VW	GOLF V (1K1) / 1.9 TDI	66 kW 1896 cc	05.2004-	132128	25
VW	GOLF V (1K1) / 1.9 TDI	66 kW 1896 cc (BRU)	05.2004-	132106	24
VW	GOLF V (1K1) / 1.9 TDI	77 kW 1896 cc	10.2003-	132106	24
VW	GOLF V (1K1) / 1.9 TDI	77 kW 1896 cc	10.2003-	132107	24
VW	GOLF V (1K1) / 1.9 TDI	77 kW 1896 cc	10.2003-	132128	25
VW	GOLF V (1K1) / 1.9 TDI	77 kW 1896 cc	10.2003-	132129	25
VW	GOLF V (1K1) / 1.9 TDI	77 kW 1896 cc (BKC)	10.2003-	132104	24
VW	GOLF V (1K1) / 1.9 TDI 4mot.	77 kW 1896 cc	08.2004-	132106	24
VW	GOLF V (1K1) / 1.9 TDI 4mot.	77 kW 1896 cc	08.2004-	132107	24
VW	GOLF V (1K1) / 1.9 TDI 4mot.	77 kW 1896 cc	08.2004-	132128	25
VW	GOLF V (1K1) / 1.9 TDI 4mot.	77 kW 1896 cc	08.2004-	132129	25
VW	GOLF V (1K1) / 1.9 TDI 4mot.	77 kW 1896 cc (BKC)	08.2004-	132104	24
VW	GOLF V (1K1) / 2.0 SDI	55 kW 1968 cc (BDK)	01.2004-	132128	25
VW	GOLF V (1K1) / 2.0 TDI	100 kW 1968 cc	10.2003-	132106	24
VW	GOLF V (1K1) / 2.0 TDI	100 kW 1968 cc	10.2003-	132128	25
VW	GOLF V (1K1) / 2.0 TDI	100 kW 1968 cc	10.2003-	132129	25
VW	GOLF V (1K1) / 2.0 TDI	100 kW 1968 cc (AZV)	10.2003-	132104	24
VW	GOLF V (1K1) / 2.0 TDI	103 kW 1968 cc	12.2004-	132128	25
VW	GOLF V (1K1) / 2.0 TDI	103 kW 1968 cc (BMM)	12.2004-	132106	24
VW	GOLF V (1K1) / 2.0 TDI	125 kW 1968 cc (BMN)	11.2005-	132106	24
VW	GOLF V (1K1) / 2.0 TDI 16V	103 kW 1968 cc	10.2003-	132106	24
VW	GOLF V (1K1) / 2.0 TDI 16V	103 kW 1968 cc	10.2003-	132107	24
VW	GOLF V (1K1) / 2.0 TDI 16V	103 kW 1968 cc	10.2003-	132128	25
VW	GOLF V (1K1) / 2.0 TDI 16V	103 kW 1968 cc	10.2003-	132129	25
VW	GOLF V (1K1) / 2.0 TDI 16V	103 kW 1968 cc (BKD)	10.2003-	132104	24
VW	GOLF V (1K1) / 2.0 TDI 16V 4mot.	103 kW 1968 cc	08.2004-	132106	24
VW	GOLF V (1K1) / 2.0 TDI 16V 4mot.	103 kW 1968 cc	08.2004-	132107	24
VW	GOLF V (1K1) / 2.0 TDI 16V 4mot.	103 kW 1968 cc	08.2004-	132128	25
VW	GOLF V (1K1) / 2.0 TDI 16V 4mot.	103 kW 1968 cc	08.2004-	132129	25
VW	GOLF V (1K1) / 2.0 TDI 16V 4mot.	103 kW 1968 cc (BKD)	08.2004-	132104	24
VW	GOLF V (1K1) / 2.0 TDI 4mot.	103 kW 1968 cc	08.2004-	132128	25
VW	GOLF V (1K1) / 2.0 TDI 4mot.	103 kW 1968 cc (BMM)	08.2004-	132106	24
VW	GOLF V Vari. (1K5) / 1.9 TDI	77 kW 1896 cc	06.2007-	132106	24
VW	GOLF V Vari. (1K5) / 1.9 TDI	77 kW 1896 cc	06.2007-	132107	24



Modell
Model

Motor
Engine



Baujahr
Construction year

HÜCO-NO. Seite
Page

VW	GOLF V Vari. (1K5) / 1.9 TDI	77 kW 1896 cc	06.2007-	132128	25
VW	GOLF V Vari. (1K5) / 1.9 TDI	77 kW 1896 cc	06.2007-	132129	25
VW	GOLF V Vari. (1K5) / 1.9 TDI	77 kW 1896 cc (BKC)	06.2007-	132104	24
VW	GOLF V Vari. (1K5) / 1.9 TDI 4mot.	77 kW 1896 cc	01.2008-	132128	25
VW	GOLF V Vari. (1K5) / 1.9 TDI 4mot.	77 kW 1896 cc	01.2008-	132129	25
VW	GOLF V Vari. (1K5) / 1.9 TDI 4mot.	77 kW 1896 cc (BLS)	01.2008-	132106	24
VW	GOLF V Vari. (1K5) / 2.0 TDI	100 kW 1968 cc	06.2007-	132106	24
VW	GOLF V Vari. (1K5) / 2.0 TDI	100 kW 1968 cc	06.2007-	132128	25
VW	GOLF V Vari. (1K5) / 2.0 TDI	100 kW 1968 cc	06.2007-	132129	25
VW	GOLF V Vari. (1K5) / 2.0 TDI	100 kW 1968 cc (AZV)	06.2007-	132104	24
VW	GOLF V Vari. (1K5) / 2.0 TDI	103 kW 1968 cc	06.2007-	132128	25
VW	GOLF V Vari. (1K5) / 2.0 TDI	103 kW 1968 cc (BMM)	06.2007-	132106	24
VW	GOLF V Vari. (1K5) / 2.0 TDI 16V	103 kW 1968 cc	06.2007-	132106	24
VW	GOLF V Vari. (1K5) / 2.0 TDI 16V	103 kW 1968 cc	06.2007-	132107	24
VW	GOLF V Vari. (1K5) / 2.0 TDI 16V	103 kW 1968 cc	06.2007-	132128	25
VW	GOLF V Vari. (1K5) / 2.0 TDI 16V	103 kW 1968 cc	06.2007-	132129	25
VW	GOLF V Vari. (1K5) / 2.0 TDI 16V	103 kW 1968 cc (BKD)	06.2007-	132104	24
VW	GOLF V Vari. (1K5) / 2.0 TDI 4mot.	100 kW 1968 cc	06.2007-	132106	24
VW	GOLF V Vari. (1K5) / 2.0 TDI 4mot.	100 kW 1968 cc	06.2007-	132128	25
VW	GOLF V Vari. (1K5) / 2.0 TDI 4mot.	100 kW 1968 cc	06.2007-	132129	25
VW	GOLF V Vari. (1K5) / 2.0 TDI 4mot.	100 kW 1968 cc (AZV)	06.2007-	132104	24
VW	GOLF VI (5K1) / 1.6 TDI	66 kW 1598 cc (CAYB)	02.2009-	132106	24
VW	GOLF VI (5K1) / 1.6 TDI	77 kW 1598 cc	02.2009-	132129	25
VW	GOLF VI (5K1) / 1.6 TDI	77 kW 1598 cc (CAYC)	02.2009-	132106	24
VW	GOLF VI (5K1) / 2.0 TDI	100 kW 1968 cc	10.2008-	132129	25
VW	GOLF VI (5K1) / 2.0 TDI	100 kW 1968 cc (CBAA)	10.2008-	132106	24
VW	GOLF VI (5K1) / 2.0 TDI	103 kW 1968 cc	10.2008-	132108	24
VW	GOLF VI (5K1) / 2.0 TDI	103 kW 1968 cc	10.2008-	132127	25
VW	GOLF VI (5K1) / 2.0 TDI	103 kW 1968 cc	10.2008-	132129	25
VW	GOLF VI (5K1) / 2.0 TDI	103 kW 1968 cc (CFFB)	10.2008-	132106	24
VW	GOLF VI (5K1) / 2.0 TDI	125 kW 1968 cc (CFGB)	04.2009-	132129	25
VW	GOLF VI (5K1) / 2.0 TDI	81 kW 1968 cc	10.2008-	132129	25
VW	GOLF VI (5K1) / 2.0 TDI	81 kW 1968 cc (CBDC)	10.2008-	132128	25
VW	GOLF VI (5K1) / 2.0 TDI 4mot.	103 kW 1968 cc	05.2009-	132129	25
VW	GOLF VI (5K1) / 2.0 TDI 4mot.	103 kW 1968 cc (CFFB)	05.2009-	132106	24
VW	GOLF VI Cabriolet / 1.6 TDI	77 kW 1598 cc	03.2011-	132129	25
VW	GOLF VI Cabriolet / 1.6 TDI	77 kW 1598 cc (CAYC)	03.2011-	132106	24
VW	GOLF VI Cabriolet / 2.0 TDI	103 kW 1968 cc	11.2011-	132128	25
VW	GOLF VI Cabriolet / 2.0 TDI	103 kW 1968 cc (CFHC)	11.2011-	132106	24
VW	GOLF VI Vari. (AJ5) / 1.6 TDI	66 kW 1598 cc (CAYB)	12.2009-	132106	24
VW	GOLF VI Vari. (AJ5) / 1.6 TDI	77 kW 1598 cc	07.2009-	132129	25
VW	GOLF VI Vari. (AJ5) / 1.6 TDI	77 kW 1598 cc (CAYC)	07.2009-	132106	24
VW	GOLF VI Vari. (AJ5) / 1.6 TDI 4mot.	77 kW 1598 cc	07.2009-	132129	25
VW	GOLF VI Vari. (AJ5) / 1.6 TDI 4mot.	77 kW 1598 cc (CAYC)	07.2009-	132106	24
VW	GOLF VI Vari. (AJ5) / 2.0 TDI	100 kW 1968 cc (CBDA)	07.2009-	132106	24
VW	GOLF VI Vari. (AJ5) / 2.0 TDI	103 kW 1968 cc	07.2009-	132128	25
VW	GOLF VI Vari. (AJ5) / 2.0 TDI	103 kW 1968 cc (BMM)	07.2009-	132106	24
VW	GOLF VI Vari. (AJ5) / 2.0 TDI 16V	103 kW 1968 cc	07.2009-	132128	25
VW	GOLF VI Vari. (AJ5) / 2.0 TDI 16V	103 kW 1968 cc (CBDB)	07.2009-	132106	24
VW	JETTA (16) / 1.5 D	37 kW 1471 cc	08.1978-07.1980	132063	23
VW	JETTA (16) / 1.5 D	37 kW 1968 cc	08.1978-07.1980	132062	23
VW	JETTA (16) / 1.6 D	40 kW 1588 cc	08.1980-02.1984	132062	23
VW	JETTA (16) / 1.6 D	40 kW 1588 cc	08.1980-02.1984	132063	23
VW	JETTA (16) / 1.6 D	40 kW 1896 cc	08.1980-02.1984	132061	23
VW	JETTA (16) / 1.6 TD	51 kW 1588 cc	03.1982-02.1984	132062	23
VW	JETTA (16) / 1.6 TD	51 kW 1588 cc	03.1982-02.1984	132063	23
VW	JETTA (16) / 1.6 TD	51 kW 2188 cc	03.1982-02.1984	132061	23
VW	JETTA I (16) / 1.5 D	37 kW 1471 cc	08.1978-07.1980	132062	23
VW	JETTA I (16) / 1.5 D	37 kW 1471 cc	08.1978-07.1980	132063	23
VW	JETTA I (16) / 1.6 D	40 kW 1588 cc	08.1980-02.1984	132061	23
VW	JETTA I (16) / 1.6 D	40 kW 1588 cc	08.1980-02.1984	132062	23
VW	JETTA I (16) / 1.6 D	40 kW 1588 cc	08.1980-02.1984	132063	23
VW	JETTA I (16) / 1.6 TD	51 kW 1588 cc	03.1982-02.1984	132061	23
VW	JETTA I (16) / 1.6 TD	51 kW 1588 cc	03.1982-02.1984	132062	23
VW	JETTA I (16) / 1.6 TD	51 kW 1588 cc	03.1982-02.1984	132063	23
VW	JETTA I Stufenh. (16) / 1.5 D	37 kW 1471 cc	08.1978-07.1980	132062	23
VW	JETTA I Stufenh. (16) / 1.5 D	37 kW 1471 cc	08.1978-07.1980	132063	23

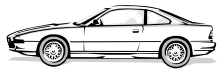

Modell
Model

Motor
Engine



Baujahr
Construction year

HÜCO-NO. Seite
Page

	Modell Model	Motor Engine	Baujahr Construction year	HÜCO-NO.	Seite Page
VW	JETTA I Stufenh. (16) / 1.6 D	40 kW 1588 cc	08.1980-02.1984	132061	23
VW	JETTA I Stufenh. (16) / 1.6 D	40 kW 1588 cc	08.1980-02.1984	132062	23
VW	JETTA I Stufenh. (16) / 1.6 D	40 kW 1588 cc	08.1980-02.1984	132063	23
VW	JETTA I Stufenh. (16) / 1.6 TD	51 kW 1588 cc	03.1982-02.1984	132061	23
VW	JETTA I Stufenh. (16) / 1.6 TD	51 kW 1588 cc	03.1982-02.1984	132062	23
VW	JETTA I Stufenh. (16) / 1.6 TD	51 kW 1588 cc	03.1982-02.1984	132063	23
VW	JETTA I Stufenh. (1K2) / 1.6 TDI	66 kW 1598 cc (CAYB)	12.2009-10.2010	132106	24
VW	JETTA I Stufenh. (1K2) / 1.6 TDI	77 kW 1598 cc	06.2009-10.2010	132129	25
VW	JETTA I Stufenh. (1K2) / 1.6 TDI	77 kW 1598 cc (CAYC)	06.2009-10.2010	132106	24
VW	JETTA I Stufenh. (1K2) / 1.9 TDI	77 kW 1896 cc	08.2005-10.2010	132106	24
VW	JETTA I Stufenh. (1K2) / 1.9 TDI	77 kW 1896 cc	08.2005-10.2010	132107	24
VW	JETTA I Stufenh. (1K2) / 1.9 TDI	77 kW 1896 cc	08.2005-10.2010	132128	25
VW	JETTA I Stufenh. (1K2) / 1.9 TDI	77 kW 1896 cc	08.2005-10.2010	132129	25
VW	JETTA I Stufenh. (1K2) / 1.9 TDI	77 kW 1896 cc (BKC)	08.2005-10.2010	132104	24
VW	JETTA I Stufenh. (1K2) / 2.0 TDI	100 kW 1968 cc	09.2005-10.2010	132106	24
VW	JETTA I Stufenh. (1K2) / 2.0 TDI	100 kW 1968 cc	09.2005-10.2010	132128	25
VW	JETTA I Stufenh. (1K2) / 2.0 TDI	100 kW 1968 cc	09.2005-10.2010	132129	25
VW	JETTA I Stufenh. (1K2) / 2.0 TDI	100 kW 1968 cc (AZV)	09.2005-10.2010	132104	24
VW	JETTA I Stufenh. (1K2) / 2.0 TDI	103 kW 1968 cc	10.2005-10.2010	132128	25
VW	JETTA I Stufenh. (1K2) / 2.0 TDI	103 kW 1968 cc (BMM)	10.2005-10.2010	132106	24
VW	JETTA I Stufenh. (1K2) / 2.0 TDI	125 kW 1968 cc (BMN)	10.2006-10.2010	132106	24
VW	JETTA I Stufenh. (1K2) / 2.0 TDI 16V	103 kW 1968 cc	08.2005-10.2010	132106	24
VW	JETTA I Stufenh. (1K2) / 2.0 TDI 16V	103 kW 1968 cc	08.2005-10.2010	132107	24
VW	JETTA I Stufenh. (1K2) / 2.0 TDI 16V	103 kW 1968 cc	08.2005-10.2010	132108	24
VW	JETTA I Stufenh. (1K2) / 2.0 TDI 16V	103 kW 1968 cc	08.2005-10.2010	132127	25
VW	JETTA I Stufenh. (1K2) / 2.0 TDI 16V	103 kW 1968 cc	08.2005-10.2010	132128	25
VW	JETTA I Stufenh. (1K2) / 2.0 TDI 16V	103 kW 1968 cc	08.2005-10.2010	132129	25
VW	JETTA I Stufenh. (1K2) / 2.0 TDI 16V	103 kW 1968 cc (BKD)	08.2005-10.2010	132104	24
VW	JETTA II (19E, 1G2) / 1.8 KAT	79 kW 1781 cc	01.1987-10.1991	132021	17
VW	JETTA II (19E, 1G2) / 1.6 D	40 kW 1588 cc	01.1984-10.1991	132062	23
VW	JETTA II (19E, 1G2) / 1.6 D	40 kW 1588 cc	01.1984-10.1991	132063	23
VW	JETTA II (19E, 1G2) / 1.6 D	40 kW 1997 cc	01.1984-10.1991	132061	23
VW	JETTA II (19E, 1G2) / 1.6 TD	44 kW 1589 cc	01.1990-10.1991	132062	23
VW	JETTA II (19E, 1G2) / 1.6 TD	44 kW 1589 cc	01.1990-10.1991	132063	23
VW	JETTA II (19E, 1G2) / 1.6 TD	44 kW 1997 cc	01.1990-10.1991	132061	23
VW	JETTA II (19E, 1G2) / 1.6 TD	51 kW 1588 cc	01.1984-10.1991	132062	23
VW	JETTA II (19E, 1G2) / 1.6 TD	51 kW 1588 cc	01.1984-10.1991	132063	23
VW	JETTA II (19E, 1G2) / 1.6 TD	51 kW 1997 cc	01.1984-10.1991	132061	23
VW	JETTA II (19E, 1G2) / 1.6 TD	59 kW 1588 cc	04.1989-10.1991	132062	23
VW	JETTA II (19E, 1G2) / 1.6 TD	59 kW 1588 cc	04.1989-10.1991	132063	23
VW	JETTA II (19E, 1G2) / 1.6 TD	59 kW 1588 cc (SB)	04.1989-10.1991	132061	23
VW	JETTA II (19E, 1G2) / 1.8	62 kW 1781 cc	08.1986-01.1990	132021	17
VW	JETTA II (19E, 1G2) / 1.8	62 kW 1781 cc	08.1986-01.1990	132023	17
VW	JETTA II (19E, 1G2) / 1.8	62 kW 1997 cc	08.1986-01.1990	132020	16
VW	JETTA II (19E, 1G2) / 1.8	79 kW 1781 cc	08.1985-10.1987	132020	16
VW	JETTA II (19E, 1G2) / 1.8	79 kW 1781 cc	08.1985-10.1987	132021	17
VW	JETTA II (19E, 1G2) / 1.8	79 kW 1781 cc	08.1985-10.1987	132023	17
VW	JETTA II (19E, 1G2) / 1.8	82 kW 1781 cc	01.1984-10.1991	132020	16
VW	JETTA II (19E, 1G2) / 1.8	82 kW 1781 cc	01.1984-10.1991	132021	17
VW	JETTA II (19E, 1G2) / 1.8	82 kW 1781 cc	01.1984-10.1991	132023	17
VW	JETTA II (19E, 1G2) / 1.8 KAT	66 kW 1781 cc	08.1987-10.1991	132021	17
VW	JETTA II (19E, 1G2) / 1.8 KAT	66 kW 2179 cc	08.1987-10.1991	132021	17
VW	JETTA II (19E, 1G2) / 1.8 KAT	79 kW 1781 cc	01.1987-10.1991	132021	17
VW	JETTA II (19E, 1G2) / 1.8 Syncro	66 kW 1471 cc	08.1987-12.1988	132021	17
VW	JETTA II (19E, 1G2) / 1.8 Syncro	72 kW 1588 cc	08.1988-07.1991	132021	17
VW	JETTA II Stufenh. 1.8 Syncro	66 kW 1781 cc	08.1987-12.1988	132021	17
VW	JETTA II Stufenh. 1.8 Syncro	72 kW 1781 cc	08.1988-07.1991	132021	17
VW	JETTA II Stufenh. (19E, 1G2) / 1.6 D	40 kW 1588 cc	01.1984-10.1991	132061	23
VW	JETTA II Stufenh. (19E, 1G2) / 1.6 D	40 kW 1588 cc	01.1984-10.1991	132062	23
VW	JETTA II Stufenh. (19E, 1G2) / 1.6 D	40 kW 1588 cc	01.1984-10.1991	132063	23
VW	JETTA II Stufenh. (19E, 1G2) / 1.6 TD	44 kW 1589 cc	01.1990-10.1991	132061	23
VW	JETTA II Stufenh. (19E, 1G2) / 1.6 TD	44 kW 1589 cc	01.1990-10.1991	132062	23
VW	JETTA II Stufenh. (19E, 1G2) / 1.6 TD	44 kW 1589 cc	01.1990-10.1991	132063	23
VW	JETTA II Stufenh. (19E, 1G2) / 1.6 TD	51 kW 1588 cc	01.1984-10.1991	132061	23
VW	JETTA II Stufenh. (19E, 1G2) / 1.6 TD	51 kW 1588 cc	01.1984-10.1991	132062	23
VW	JETTA II Stufenh. (19E, 1G2) / 1.6 TD	51 kW 1588 cc	01.1984-10.1991	132063	23
VW	JETTA II Stufenh. (19E, 1G2) / 1.6 TD	59 kW 1588 cc	04.1989-10.1991	132061	23



Modell
Model

Motor
Engine



Baujahr
Construction year

HÜCO-NO. Seite
Page

VW	JETTA II Stufenh. (19E, 1G2) / 1.6 TD	59 kW 1588 cc	04.1989-10.1991	132062	23
VW	JETTA II Stufenh. (19E, 1G2) / 1.6 TD	59 kW 1588 cc	04.1989-10.1991	132063	23
VW	JETTA II Stufenh. (19E, 1G2) / 1.8	62 kW 1781 cc	08.1986-01.1990	132020	16
VW	JETTA II Stufenh. (19E, 1G2) / 1.8	62 kW 1781 cc	08.1986-01.1990	132021	17
VW	JETTA II Stufenh. (19E, 1G2) / 1.8	62 kW 1781 cc	08.1986-01.1990	132023	17
VW	JETTA II Stufenh. (19E, 1G2) / 1.8	79 kW 1781 cc	08.1985-10.1987	132020	16
VW	JETTA II Stufenh. (19E, 1G2) / 1.8	79 kW 1781 cc	08.1985-10.1987	132021	17
VW	JETTA II Stufenh. (19E, 1G2) / 1.8	79 kW 1781 cc	08.1985-10.1987	132023	17
VW	JETTA II Stufenh. (19E, 1G2) / 1.8	82 kW 1781 cc	01.1984-10.1991	132020	16
VW	JETTA II Stufenh. (19E, 1G2) / 1.8	82 kW 1781 cc	01.1984-10.1991	132021	17
VW	JETTA II Stufenh. (19E, 1G2) / 1.8	82 kW 1781 cc	01.1984-10.1991	132023	17
VW	JETTA III (1H2) / 1.9 TD	55 kW 1896 cc (AAZ)	11.1991-09.1998	132062	23
VW	JETTA III (1K2) / 1.6 TDI	66 kW 1598 cc	12.2009-10.2010	132106	24
VW	JETTA III (1K2) / 1.6 TDI	77 kW 1598 cc	06.2009-10.2010	132106	24
VW	JETTA III (1K2) / 1.6 TDI	77 kW 1598 cc	06.2009-10.2010	132129	25
VW	JETTA III (1K2) / 1.9 TDI	77 kW 1896 cc	08.2005-10.2010	132104	24
VW	JETTA III (1K2) / 1.9 TDI	77 kW 1896 cc	08.2005-10.2010	132106	24
VW	JETTA III (1K2) / 1.9 TDI	77 kW 1896 cc	08.2005-10.2010	132107	24
VW	JETTA III (1K2) / 1.9 TDI	77 kW 1896 cc	08.2005-10.2010	132128	25
VW	JETTA III (1K2) / 1.9 TDI	77 kW 1896 cc	08.2005-10.2010	132129	25
VW	JETTA III (1K2) / 2.0 TDI	100 kW 1968 cc	09.2005-10.2010	132104	24
VW	JETTA III (1K2) / 2.0 TDI	100 kW 1968 cc	09.2005-10.2010	132106	24
VW	JETTA III (1K2) / 2.0 TDI	100 kW 1968 cc	09.2005-10.2010	132128	25
VW	JETTA III (1K2) / 2.0 TDI	100 kW 1968 cc	09.2005-10.2010	132129	25
VW	JETTA III (1K2) / 2.0 TDI	103 kW 1968 cc	10.2005-10.2010	132106	24
VW	JETTA III (1K2) / 2.0 TDI	103 kW 1968 cc	10.2005-10.2010	132128	25
VW	JETTA III (1K2) / 2.0 TDI	125 kW 1968 cc	10.2006-10.2010	132106	24
VW	JETTA III (1K2) / 2.0 TDI 16V	103 kW 1968 cc	08.2005-10.2010	132104	24
VW	JETTA III (1K2) / 2.0 TDI 16V	103 kW 1968 cc	08.2005-10.2010	132106	24
VW	JETTA III (1K2) / 2.0 TDI 16V	103 kW 1968 cc	08.2005-10.2010	132107	24
VW	JETTA III (1K2) / 2.0 TDI 16V	103 kW 1968 cc	08.2005-10.2010	132108	24
VW	JETTA III (1K2) / 2.0 TDI 16V	103 kW 1968 cc	08.2005-10.2010	132127	25
VW	JETTA III (1K2) / 2.0 TDI 16V	103 kW 1968 cc	08.2005-10.2010	132128	25
VW	JETTA III (1K2) / 2.0 TDI 16V	103 kW 1968 cc	08.2005-10.2010	132129	25
VW	JETTA IV (162) / 1.6 TDI	77 kW 1598 cc	02.2011-	132129	25
VW	JETTA IV (162) / 1.6 TDI	77 kW 1598 cc (CAYC)	02.2011-	132106	24
VW	JETTA IV (162) / 2.0 TDI	103 kW 1968 cc	02.2011-	132108	24
VW	JETTA IV (162) / 2.0 TDI	103 kW 1968 cc	02.2011-	132127	25
VW	JETTA IV (162) / 2.0 TDI	103 kW 1968 cc	02.2011-	132128	25
VW	JETTA IV (162) / 2.0 TDI	103 kW 1968 cc	02.2011-	132129	25
VW	JETTA IV (162) / 2.0 TDI	103 kW 1968 cc (CFHC)	02.2011-	132106	24
VW	JETTA IV (162) / 2.0 TDI	81 kW 1968 cc (CLCA)	10.2010-	132128	25
VW	JETTA IV (1J2) / 1.9 TDI	110 kW 1896 cc	05.2000-05.2005	132105	24
VW	JETTA IV (1J2) / 1.9 TDI	74 kW 1896 cc	09.2000-05.2005	132128	25
VW	JETTA IV (1J2) / 1.9 TDI	96 kW 1896 cc	11.2000-05.2005	132105	24
VW	JETTA IV (1J2) / 1.9 TDI 4mot.	110 kW 1896 cc	05.2000-05.2005	132105	24
VW	JETTA IV (1J2) / 1.9 TDI 4mot.	96 kW 1896 cc	11.2000-05.2005	132105	24
VW	JETTA IV Kombi (1J6) / 1.9 TDI	110 kW 1896 cc	05.2001-05.2005	132105	24
VW	JETTA IV Kombi (1J6) / 1.9 TDI	74 kW 1896 cc	09.2000-05.2005	132128	25
VW	JETTA IV Kombi (1J6) / 1.9 TDI	96 kW 1896 cc	11.2000-05.2005	132105	24
VW	JETTA IV Kombi (1J6) / 1.9 TDI 4mot	110 kW 1896 cc	05.2001-05.2005	132105	24
VW	JETTA IV Kombi (1J6) / 1.9 TDI 4mot	96 kW 1896 cc	11.2000-05.2005	132105	24
VW	JETTA Mk II (19E, 1G2) / 1.6 D	40 kW 1588 cc	01.1984-10.1991	132061	23
VW	JETTA Mk II (19E, 1G2) / 1.6 D	40 kW 1588 cc	01.1984-10.1991	132062	23
VW	JETTA Mk II (19E, 1G2) / 1.6 D	40 kW 1588 cc	01.1984-10.1991	132063	23
VW	JETTA Mk II (19E, 1G2) / 1.6 TD	44 kW 1589 cc	01.1990-10.1991	132061	23
VW	JETTA Mk II (19E, 1G2) / 1.6 TD	44 kW 1589 cc	01.1990-10.1991	132062	23
VW	JETTA Mk II (19E, 1G2) / 1.6 TD	44 kW 1589 cc	01.1990-10.1991	132063	23
VW	JETTA Mk II (19E, 1G2) / 1.6 TD	51 kW 1588 cc	01.1984-10.1991	132061	23
VW	JETTA Mk II (19E, 1G2) / 1.6 TD	51 kW 1588 cc	01.1984-10.1991	132062	23
VW	JETTA Mk II (19E, 1G2) / 1.6 TD	51 kW 1588 cc	01.1984-10.1991	132063	23
VW	JETTA Mk II (19E, 1G2) / 1.6 TD	59 kW 1588 cc	04.1989-10.1991	132061	23
VW	JETTA Mk II (19E, 1G2) / 1.6 TD	59 kW 1588 cc	04.1989-10.1991	132062	23
VW	JETTA Mk II (19E, 1G2) / 1.6 TD	59 kW 1588 cc	04.1989-10.1991	132063	23
VW	JETTA Mk II (19E, 1G2) / 1.8	62 kW 1781 cc	08.1986-01.1990	132020	16
VW	JETTA Mk II (19E, 1G2) / 1.8	62 kW 1781 cc	08.1986-01.1990	132021	17
VW	JETTA Mk II (19E, 1G2) / 1.8	62 kW 1781 cc	08.1986-01.1990	132023	17



Modell
Model

Motor
Engine



Baujahr
Construction year

HÜCO-NO. Seite
Page

	Modell Model	Motor Engine	Baujahr Construction year	HÜCO-NO.	Seite Page
VW	JETTA Mk II (19E, 1G2) / 1.8	79 kW 1781 cc	08.1985-10.1987	132020	16
VW	JETTA Mk II (19E, 1G2) / 1.8	79 kW 1781 cc	08.1985-10.1987	132021	17
VW	JETTA Mk II (19E, 1G2) / 1.8	79 kW 1781 cc	08.1985-10.1987	132023	17
VW	JETTA Mk II (19E, 1G2) / 1.8	82 kW 1781 cc	01.1984-10.1991	132020	16
VW	JETTA Mk II (19E, 1G2) / 1.8	82 kW 1781 cc	01.1984-10.1991	132021	17
VW	JETTA Mk II (19E, 1G2) / 1.8	82 kW 1781 cc	01.1984-10.1991	132023	17
VW	JETTA Mk II (19E, 1G2) / 1.8 KAT	66 kW 1781 cc	08.1987-10.1991	132021	17
VW	JETTA Mk II (19E, 1G2) / 1.8 KAT	79 kW 1781 cc	01.1987-10.1991	132021	17
VW	JETTA Mk II (19E, 1G2) / 1.8 Syncro	66 kW 1781 cc	08.1987-12.1988	132021	17
VW	JETTA Mk II (19E, 1G2) / 1.8 Syncro	72 kW 1781 cc	08.1988-07.1991	132021	17
VW	JETTA V III (1K2) / 1.6 TDI	66 kW 1598 cc	12.2009-10.2010	132106	24
VW	JETTA V III (1K2) / 1.6 TDI	77 kW 1598 cc	06.2009-10.2010	132106	24
VW	JETTA V III (1K2) / 1.6 TDI	77 kW 1598 cc	06.2009-10.2010	132129	25
VW	JETTA V III (1K2) / 1.9 TDI	77 kW 1896 cc	08.2005-10.2010	132104	24
VW	JETTA V III (1K2) / 1.9 TDI	77 kW 1896 cc	08.2005-10.2010	132106	24
VW	JETTA V III (1K2) / 1.9 TDI	77 kW 1896 cc	08.2005-10.2010	132107	24
VW	JETTA V III (1K2) / 1.9 TDI	77 kW 1896 cc	08.2005-10.2010	132128	25
VW	JETTA V III (1K2) / 1.9 TDI	77 kW 1896 cc	08.2005-10.2010	132129	25
VW	JETTA V III (1K2) / 2.0 TDI	100 kW 1968 cc	09.2005-10.2010	132104	24
VW	JETTA V III (1K2) / 2.0 TDI	100 kW 1968 cc	09.2005-10.2010	132106	24
VW	JETTA V III (1K2) / 2.0 TDI	100 kW 1968 cc	09.2005-10.2010	132128	25
VW	JETTA V III (1K2) / 2.0 TDI	100 kW 1968 cc	09.2005-10.2010	132129	25
VW	JETTA V III (1K2) / 2.0 TDI	103 kW 1968 cc	10.2005-10.2010	132106	24
VW	JETTA V III (1K2) / 2.0 TDI	103 kW 1968 cc	10.2005-10.2010	132128	25
VW	JETTA V III (1K2) / 2.0 TDI	125 kW 1968 cc	10.2006-10.2010	132106	24
VW	JETTA V III (1K2) / 2.0 TDI 16V	103 kW 1968 cc	08.2005-10.2010	132104	24
VW	JETTA V III (1K2) / 2.0 TDI 16V	103 kW 1968 cc	08.2005-10.2010	132106	24
VW	JETTA V III (1K2) / 2.0 TDI 16V	103 kW 1968 cc	08.2005-10.2010	132107	24
VW	JETTA V III (1K2) / 2.0 TDI 16V	103 kW 1968 cc	08.2005-10.2010	132108	24
VW	JETTA V III (1K2) / 2.0 TDI 16V	103 kW 1968 cc	08.2005-10.2010	132127	25
VW	JETTA V III (1K2) / 2.0 TDI 16V	103 kW 1968 cc	08.2005-10.2010	132128	25
VW	JETTA V III (1K2) / 2.0 TDI 16V	103 kW 1968 cc	08.2005-10.2010	132129	25
VW	JETTA VI IV (162) / 1.6 TDI	77 kW 1598 cc	02.2011-	132106	24
VW	JETTA VI IV (162) / 1.6 TDI	77 kW 1598 cc	02.2011-	132129	25
VW	JETTA VI IV (162) / 2.0 TDI	103 kW 1968 cc	02.2011-	132106	24
VW	JETTA VI IV (162) / 2.0 TDI	103 kW 1968 cc	02.2011-	132108	24
VW	JETTA VI IV (162) / 2.0 TDI	103 kW 1968 cc	02.2011-	132127	25
VW	JETTA VI IV (162) / 2.0 TDI	103 kW 1968 cc	02.2011-	132128	25
VW	JETTA VI IV (162) / 2.0 TDI	103 kW 1968 cc	02.2011-	132129	25
VW	JETTA VI IV (162) / 2.0 TDI	81 kW 1968 cc	10.2010-	132128	25
VW	LT 28-35 I Bus (281-363) / 2.4 D	51 kW 2383 cc (ACT)	08.1989-06.1996	132062	23
VW	LT 28-35 I Bus (281-363) / 2.4 D	55 kW 1997 cc	01.1979-07.1992	132062	23
VW	LT 28-35 I Bus (281-363) / 2.4 D	55 kW 2383 cc	01.1979-07.1992	132063	23
VW	LT 28-35 I Bus (281-363) / 2.4 TD	68 kW 2383 cc	08.1989-08.1992	132062	23
VW	LT 28-35 I Bus (281-363) / 2.4 TD	68 kW 2383 cc	08.1989-08.1992	132063	23
VW	LT 28-35 I Bus (281-363) / 2.4 TD	70 kW 2383 cc (ACL)	09.1992-06.1996	132062	23
VW	LT 28-35 I Bus (281-363) / 2.4 TD	75 kW 2383 cc	12.1982-07.1989	132063	23
VW	LT 28-35 I Bus (281-363) / 2.4 TD	75 kW 2383 cc (DV)	12.1982-07.1989	132062	23
VW	LT 28-35 I Kasten (281-363) / 2.4 D	51 kW 2383 cc (ACT)	07.1990-05.1996	132062	23
VW	LT 28-35 I Kasten (281-363) / 2.4 D	55 kW 2383 cc	01.1979-07.1992	132062	23
VW	LT 28-35 I Kasten (281-363) / 2.4 D	55 kW 2383 cc	01.1979-07.1992	132063	23
VW	LT 28-35 I Kasten (281-363) / 2.4 TD	70 kW 2383 cc (ACL)	06.1992-05.1996	132062	23
VW	LT 28-35 I Kasten (281-363) / 2.4 TD	75 kW 2383 cc (DV)	02.1986-08.1992	132062	23
VW	LT 28-35 I Kasten (281-363) / 2.7 D	48 kW 2710 cc (CG)	11.1975-01.1980	132061	23
VW	LT 28-35 I Kasten 2.4 TD Syncro	70 kW 2383 cc (ACL)	08.1992-04.1996	132062	23
VW	LT 28-35 I Pritsche 2.4 TD Syncro	70 kW 2383 cc (ACL)	08.1992-04.1996	132062	23
VW	LT 28-35 I Pritsche (281-363) / 2.4 D	51 kW 2383 cc (ACT)	08.1990-06.1996	132062	23
VW	LT 28-35 I Pritsche (281-363) / 2.4 D	55 kW 1598 cc	12.1978-02.1991	132062	23
VW	LT 28-35 I Pritsche (281-363) / 2.4 D	55 kW 2383 cc	12.1978-02.1991	132063	23
VW	LT 28-35 I Pritsche (281-363) / 2.4 TD	68 kW 2383 cc	08.1990-08.1992	132062	23
VW	LT 28-35 I Pritsche (281-363) / 2.4 TD	68 kW 2383 cc	08.1990-08.1992	132063	23
VW	LT 28-35 I Pritsche (281-363) / 2.4 TD	70 kW 2383 cc (ACL)	08.1992-06.1996	132062	23
VW	LT 28-35 I Pritsche (281-363) / 2.4 TD	75 kW 2383 cc	12.1982-09.1993	132063	23
VW	LT 28-35 I Pritsche (281-363) / 2.4 TD	75 kW 2383 cc (DV)	12.1982-09.1993	132062	23
VW	LT 28-35 I Pritsche (281-363) / 2.7 D	48 kW 2710 cc (CG)	11.1975-01.1980	132061	23
VW	LT 28-35 II Bus (2DM) / 2.5 TDI	61 kW 2461 cc (BBE)	05.2001-07.2006	132165	33
VW	LT 28-35 II Bus (2DM) / 2.5 TDI	70 kW 2461 cc (BBF)	05.2001-07.2006	132165	33



Modell
Model

Motor
Engine



Baujahr
Construction year

HÜCO-NO. Seite
Page

VW	LT 28-35 II Bus (2DM) / 2.5 TDI	80 kW 2461 cc (AVR)	05.1999-07.2006	132165	33
VW	LT 28-35 II Bus (2DM) / 2.8 TDi	116 kW 2798 cc (BCQ)	05.2001-06.2006	132165	33
VW	LT 28-46 II Kasten (2DX0AE) / 2.5 TDI	61 kW 2461 cc (BBE)	05.2001-07.2006	132165	33
VW	LT 28-46 II Kasten (2DX0AE) / 2.5 TDI	70 kW 2461 cc (BBF)	05.2001-07.2006	132165	33
VW	LT 28-46 II Kasten (2DX0AE) / 2.5 TDI	80 kW 2461 cc (AVR)	05.1999-07.2006	132165	33
VW	LT 28-46 II Kasten (2DX0AE) / 2.8 TDI	116 kW 2799 cc (BCQ)	04.2002-07.2006	132165	33
VW	LT 28-46 II Kasten (2DX0AE) / 2.8 TDI	92 kW 2799 cc (AGK)	06.1997-12.1998	132165	33
VW	LT 28-46 II Kasten (2DX0AE) / 2.8 TDI	96 kW 2799 cc (ATA)	01.1999-07.2006	132165	33
VW	LT 28-46 II Pritsche (2DX0FE) / 2.5 TDI	61 kW 2461 cc (BBE)	05.2001-07.2006	132165	33
VW	LT 28-46 II Pritsche (2DX0FE) / 2.5 TDI	70 kW 2461 cc (BBF)	05.2001-07.2006	132165	33
VW	LT 28-46 II Pritsche (2DX0FE) / 2.5 TDI	80 kW 2461 cc (AVR)	05.1999-07.2006	132165	33
VW	LT 28-46 II Pritsche (2DX0FE) / 2.8 TDI	116 kW 2799 cc (BCQ)	04.2002-07.2006	132165	33
VW	LT 28-46 II Pritsche (2DX0FE) / 2.8 TDI	92 kW 2799 cc (AGK)	06.1997-12.1998	132165	33
VW	LT 28-46 II Pritsche (2DX0FE) / 2.8 TDI	96 kW 2799 cc (ATA)	01.1999-07.2006	132165	33
VW	LT 40-55 I Kasten / 2.4 TD 4WD	75 kW 2383 cc	08.1978-07.1992	132063	23
VW	LT 40-55 I Kasten (291-512) / 2.4 D	51 kW 2383 cc (ACT)	07.1990-05.1996	132062	23
VW	LT 40-55 I Kasten (291-512) / 2.4 D	55 kW 2383 cc	01.1979-07.1992	132062	23
VW	LT 40-55 I Kasten (291-512) / 2.4 D	55 kW 2383 cc	01.1979-07.1992	132063	23
VW	LT 40-55 I Kasten (291-512) / 2.4 D 4WD	55 kW 2383 cc	01.1979-03.1986	132063	23
VW	LT 40-55 I Kasten (291-512) / 2.4 D 4WD	55 kW 2799 cc	01.1979-03.1986	132062	23
VW	LT 40-55 I Kasten (291-512) / 2.4 TD	68 kW 1608 cc	08.1988-08.1992	132062	23
VW	LT 40-55 I Kasten (291-512) / 2.4 TD	68 kW 2383 cc	08.1988-08.1992	132063	23
VW	LT 40-55 I Kasten (291-512) / 2.4 TD	70 kW 2383 cc (ACL)	06.1992-05.1996	132062	23
VW	LT 40-55 I Kasten (291-512) / 2.4 TD	75 kW 2383 cc	02.1986-08.1992	132063	23
VW	LT 40-55 I Kasten (291-512) / 2.4 TD	75 kW 2383 cc (DV)	02.1986-08.1992	132062	23
VW	LT 40-55 I Kasten / 2.4 TD 4WD	75 kW 2383 cc (DV)	08.1978-07.1992	132062	23
VW	LT 40-55 I Kasten 2.4 TD Syncro	70 kW 2383 cc (ACL)	08.1992-04.1996	132062	23
VW	LT 40-55 I Pritsche 2.4 TD Syncro	70 kW 2383 cc (ACL)	08.1992-04.1996	132062	23
VW	LT 40-55 I Pritsche (293-909) / 2.4 D	51 kW 2383 cc (ACT)	08.1990-06.1996	132062	23
VW	LT 40-55 I Pritsche (293-909) / 2.4 D	55 kW 2383 cc	12.1978-02.1991	132062	23
VW	LT 40-55 I Pritsche (293-909) / 2.4 D	55 kW 2383 cc	12.1978-02.1991	132063	23
VW	LT 40-55 I Pritsche (293-909) / 2.4 TD	70 kW 2383 cc (ACL)	08.1992-06.1996	132062	23
VW	LT 40-55 I Pritsche (293-909) / 2.4 TD	75 kW 2383 cc	12.1982-09.1993	132063	23
VW	LT 40-55 I Pritsche (293-909) / 2.4 TD	75 kW 2383 cc (DV)	12.1982-09.1993	132062	23
VW	LT Mk II Bus (2DM) / 2.5 TDI	61 kW 2461 cc	05.2001-07.2006	132165	33
VW	LT Mk II Bus (2DM) / 2.5 TDI	70 kW 2461 cc	05.2001-07.2006	132165	33
VW	LT Mk II Bus (2DM) / 2.5 TDI	80 kW 2461 cc	05.1999-07.2006	132165	33
VW	LT Mk II Bus (2DM) / 2.8 TDi	116 kW 2798 cc	05.2001-06.2006	132165	33
VW	LT Mk II Kasten (2DX0AE) / 2.5 TDI	61 kW 2461 cc	05.2001-07.2006	132165	33
VW	LT Mk II Kasten (2DX0AE) / 2.5 TDI	70 kW 2461 cc	05.2001-07.2006	132165	33
VW	LT Mk II Kasten (2DX0AE) / 2.5 TDI	80 kW 2461 cc	05.1999-07.2006	132165	33
VW	LT Mk II Kasten (2DX0AE) / 2.8 TDI	116 kW 2799 cc	04.2002-07.2006	132165	33
VW	LT Mk II Kasten (2DX0AE) / 2.8 TDI	92 kW 2799 cc	06.1997-12.1998	132165	33
VW	LT Mk II Kasten (2DX0AE) / 2.8 TDI	96 kW 2799 cc	01.1999-07.2006	132165	33
VW	LT Mk II Pritsche (2DX0FE) / 2.5 TDI	61 kW 2461 cc	05.2001-07.2006	132165	33
VW	LT Mk II Pritsche (2DX0FE) / 2.5 TDI	70 kW 2461 cc	05.2001-07.2006	132165	33
VW	LT Mk II Pritsche (2DX0FE) / 2.5 TDI	80 kW 2461 cc	05.1999-07.2006	132165	33
VW	LT Mk II Pritsche (2DX0FE) / 2.8 TDI	116 kW 2799 cc	04.2002-07.2006	132165	33
VW	LT Mk II Pritsche (2DX0FE) / 2.8 TDI	92 kW 2799 cc	06.1997-12.1998	132165	33
VW	LT Mk II Pritsche (2DX0FE) / 2.8 TDI	96 kW 2799 cc	01.1999-07.2006	132165	33
VW	LT28-50 Bus (281-363) / 2.4 D	51 kW 2383 cc	08.1989-06.1996	132062	23
VW	LT28-50 Bus (281-363) / 2.4 D	55 kW 2383 cc	01.1979-07.1992	132062	23
VW	LT28-50 Bus (281-363) / 2.4 D	55 kW 2383 cc	01.1979-07.1992	132063	23
VW	LT28-50 Bus (281-363) / 2.4 TD	68 kW 2383 cc	08.1989-08.1992	132062	23
VW	LT28-50 Bus (281-363) / 2.4 TD	68 kW 2383 cc	08.1989-08.1992	132063	23
VW	LT28-50 Bus (281-363) / 2.4 TD	70 kW 2383 cc	09.1992-06.1996	132062	23
VW	LT28-50 Bus (281-363) / 2.4 TD	75 kW 2383 cc	12.1982-07.1989	132062	23
VW	LT28-50 Bus (281-363) / 2.4 TD	75 kW 2383 cc	12.1982-07.1989	132063	23
VW	LT28-50 Kasten / 2.4 TD Syncro	70 kW 2383 cc	08.1992-04.1996	132062	23
VW	LT28-50 Kasten (281-363) / 2.4 D	51 kW 2383 cc	07.1990-05.1996	132062	23
VW	LT28-50 Kasten (281-363) / 2.4 D	55 kW 2383 cc	01.1979-07.1992	132062	23
VW	LT28-50 Kasten (281-363) / 2.4 D	55 kW 2383 cc	01.1979-07.1992	132063	23
VW	LT28-50 Kasten (281-363) / 2.4 TD	70 kW 2383 cc	06.1992-05.1996	132062	23
VW	LT28-50 Kasten (281-363) / 2.4 TD	75 kW 2383 cc	02.1986-08.1992	132062	23
VW	LT28-50 Kasten (281-363) / 2.7 D	48 kW 2710 cc	11.1975-01.1980	132061	23
VW	LT28-50 Pritsche / 2.4 TD Syncro	70 kW 2383 cc	08.1992-04.1996	132062	23
VW	LT28-50 Pritsche (281-363) / 2.4 D	51 kW 2383 cc	08.1990-06.1996	132062	23



Modell
Model

Motor
Engine



Baujahr
Construction year

HÜCO-NO. Seite
Page

	Modell Model	Motor Engine	Baujahr Construction year	HÜCO-NO.	Seite Page
VW	LT28-50 Pritsche (281-363) / 2.4 D	55 kW 2383 cc	12.1978-02.1991	132062	23
VW	LT28-50 Pritsche (281-363) / 2.4 D	55 kW 2383 cc	12.1978-02.1991	132063	23
VW	LT28-50 Pritsche (281-363) / 2.4 TD	68 kW 2383 cc	08.1990-08.1992	132062	23
VW	LT28-50 Pritsche (281-363) / 2.4 TD	68 kW 2383 cc	08.1990-08.1992	132063	23
VW	LT28-50 Pritsche (281-363) / 2.4 TD	70 kW 2383 cc	08.1992-06.1996	132062	23
VW	LT28-50 Pritsche (281-363) / 2.4 TD	75 kW 2383 cc	12.1982-09.1993	132062	23
VW	LT28-50 Pritsche (281-363) / 2.4 TD	75 kW 2383 cc	12.1982-09.1993	132063	23
VW	LT28-50 Pritsche (281-363) / 2.7 D	48 kW 2710 cc	11.1975-01.1980	132061	23
VW	LUPO (6X1, 6E1) / 1.4 TDI	55 kW 1422 cc (AMF)	01.1999-07.2005	132128	25
VW	MULTIVAN Mk V / 1.9 TDI	62 kW 1896 cc (BRR)	01.2006-11.2009	132129	25
VW	MULTIVAN Mk V / 1.9 TDI	75 kW 1896 cc (BRS)	06.2006-11.2009	132129	25
VW	MULTIVAN Mk V / 1.9 TDI	77 kW 1896 cc (AXB)	04.2003-11.2009	132129	25
VW	MULTIVAN Mk V / 2.0	85 kW 1984 cc (AXA)	11.2003-	132129	25
VW	MULTIVAN Mk V / 2.0 BitDI	132 kW 1968 cc (CFCA)	09.2009-	132129	25
VW	MULTIVAN Mk V / 2.0 BitDI 4mot.	132 kW 1968 cc (CFCA)	09.2009-	132129	25
VW	MULTIVAN Mk V / 2.0 TDI	100 kW 1968 cc (CAAE)	05.2010-	132129	25
VW	MULTIVAN Mk V / 2.0 TDI	103 kW 1968 cc (CAAC)	09.2009-	132129	25
VW	MULTIVAN Mk V / 2.0 TDI	62 kW 1968 cc (CAAA)	09.2009-	132129	25
VW	MULTIVAN Mk V / 2.0 TDI	75 kW 1968 cc (CAAB)	09.2009-	132129	25
VW	MULTIVAN Mk V / 2.0 TDI 4mot.	100 kW 1968 cc (CAAE)	05.2010-	132129	25
VW	MULTIVAN Mk V / 2.0 TDI 4mot.	103 kW 1968 cc (CAAC)	09.2009-	132129	25
VW	MULTIVAN T5 / 1.9 TDI	62 kW 1896 cc	01.2006-11.2009	132129	25
VW	MULTIVAN T5 / 1.9 TDI	75 kW 1896 cc	06.2006-11.2009	132129	25
VW	MULTIVAN T5 / 1.9 TDI	77 kW 1896 cc	04.2003-11.2009	132129	25
VW	MULTIVAN T5 / 2.0	85 kW 1984 cc	11.2003-	132129	25
VW	MULTIVAN T5 / 2.0 BitDI	132 kW 1968 cc	09.2009-	132129	25
VW	MULTIVAN T5 / 2.0 BitDI 4mot.	132 kW 1968 cc	09.2009-	132129	25
VW	MULTIVAN T5 / 2.0 TDI	100 kW 1968 cc	05.2010-	132129	25
VW	MULTIVAN T5 / 2.0 TDI	103 kW 1968 cc	09.2009-	132129	25
VW	MULTIVAN T5 / 2.0 TDI	62 kW 1968 cc	09.2009-	132129	25
VW	MULTIVAN T5 / 2.0 TDI	75 kW 1968 cc	09.2009-	132129	25
VW	MULTIVAN T5 / 2.0 TDI 4mot.	100 kW 1968 cc	05.2010-	132129	25
VW	MULTIVAN T5 / 2.0 TDI 4mot.	103 kW 1968 cc	09.2009-	132129	25
VW	MULTIVAN V / 1.9 TDI	62 kW 1896 cc	01.2006-11.2009	132129	25
VW	MULTIVAN V / 1.9 TDI	75 kW 1896 cc	06.2006-11.2009	132129	25
VW	MULTIVAN V / 1.9 TDI	77 kW 1896 cc	04.2003-11.2009	132129	25
VW	MULTIVAN V / 2.0	85 kW 1984 cc	11.2003-	132129	25
VW	MULTIVAN V / 2.0 BitDI	132 kW 1968 cc	09.2009-	132129	25
VW	MULTIVAN V / 2.0 BitDI 4mot.	132 kW 1968 cc	09.2009-	132129	25
VW	MULTIVAN V / 2.0 TDI	100 kW 1968 cc	05.2010-	132129	25
VW	MULTIVAN V / 2.0 TDI	103 kW 1968 cc	09.2009-	132129	25
VW	MULTIVAN V / 2.0 TDI	62 kW 1968 cc	09.2009-	132129	25
VW	MULTIVAN V / 2.0 TDI	75 kW 1968 cc	09.2009-	132129	25
VW	MULTIVAN V / 2.0 TDI 4mot.	100 kW 1968 cc	05.2010-	132129	25
VW	MULTIVAN V / 2.0 TDI 4mot.	103 kW 1968 cc	09.2009-	132129	25
VW	NEW BEETLE (9C1, 1C1) / 1.9 TDI	77 kW 1896 cc (BSW)	07.2005-	132128	25
VW	NEW BEETLE Cabriolet (1Y7) / 1.9 TDI	74 kW 1896 cc (AXR)	06.2003-	132128	25
VW	NEW BEETLE Cabriolet (1Y7) / 1.9 TDI	77 kW 1896 cc (BSW)	07.2005-	132128	25
VW	PASSAT (32) / 1.5 D	37 kW 1471 cc	08.1977-07.1980	132063	23
VW	PASSAT (32) / 1.5 D	37 kW 2179 cc	08.1977-07.1980	132062	23
VW	PASSAT (32B) / 1.3	40 kW 1272 cc	08.1980-07.1983	132090	24
VW	PASSAT (32B) / 1.6 D	40 kW 1588 cc	08.1980-03.1988	132062	23
VW	PASSAT (32B) / 1.6 D	40 kW 1588 cc	08.1980-03.1988	132063	23
VW	PASSAT (32B) / 1.6 TD	51 kW 1588 cc	04.1982-03.1988	132062	23
VW	PASSAT (32B) / 1.6 TD	51 kW 1588 cc	04.1982-03.1988	132063	23
VW	PASSAT (32B) / 1.6 TD	59 kW 1588 cc	05.1986-03.1988	132062	23
VW	PASSAT (32B) / 1.6 TD	59 kW 1588 cc	05.1986-03.1988	132063	23
VW	PASSAT (362) / 1.6 TDI	77 kW 1598 cc	08.2010-	132129	25
VW	PASSAT (362) / 1.6 TDI	77 kW 1598 cc (CAYC)	08.2010-	132106	24
VW	PASSAT (362) / 2.0 TDI	103 kW 1968 cc	08.2010-	132129	25
VW	PASSAT (362) / 2.0 TDI	103 kW 1968 cc (CFFB)	08.2010-	132106	24
VW	PASSAT (362) / 2.0 TDI	125 kW 1968 cc	08.2010-	132129	25
VW	PASSAT (362) / 2.0 TDI 4mot.	103 kW 1968 cc	08.2010-	132129	25
VW	PASSAT (362) / 2.0 TDI 4mot.	103 kW 1968 cc (CFFB)	08.2010-	132106	24
VW	PASSAT (362) / 2.0 TDI 4mot.	125 kW 1968 cc	08.2010-	132129	25
VW	PASSAT (3A2, 35I) / 1.6 TD	59 kW 1588 cc	08.1988-09.1993	132062	23
VW	PASSAT (3A2, 35I) / 1.6 TD	59 kW 1588 cc	08.1988-09.1993	132063	23



Modell
Model

Motor
Engine



Baujahr
Construction year

HÜCO-NO. Seite
Page

	Modell Model	Motor Engine	Baujahr Construction year	HÜCO-NO.	Seite Page
VW	PASSAT (3A2, 35I) / 1.6 TD	59 kW 1588 cc (SB)	08.1988-09.1993	132061	23
VW	PASSAT (3A2, 35I) / 1.9 D	50 kW 1588 cc	05.1989-10.1993	132062	23
VW	PASSAT (3A2, 35I) / 1.9 D	50 kW 1896 cc	05.1989-10.1993	132063	23
VW	PASSAT (3A2, 35I) / 1.9 TD	55 kW 1896 cc (AAZ)	03.1991-08.1996	132062	23
VW	PASSAT (3B3) / 2.0 TDI	100 kW 1968 cc (BGW)	12.2003-05.2005	132105	24
VW	PASSAT (3C2) / 1.6 TDI	77 kW 1598 cc	08.2009-	132129	25
VW	PASSAT (3C2) / 1.6 TDI	77 kW 1598 cc (CAYC)	08.2009-	132106	24
VW	PASSAT (3C2) / 1.9 TDI	77 kW 1896 cc	03.2005-	132106	24
VW	PASSAT (3C2) / 1.9 TDI	77 kW 1896 cc	03.2005-	132107	24
VW	PASSAT (3C2) / 1.9 TDI	77 kW 1896 cc	03.2005-	132128	25
VW	PASSAT (3C2) / 1.9 TDI	77 kW 1896 cc	03.2005-	132129	25
VW	PASSAT (3C2) / 1.9 TDI	77 kW 1896 cc (BKC)	03.2005-	132104	24
VW	PASSAT (3C2) / 2.0 BlueTDI	105 kW 1968 cc (CBAC)	01.2009-	132129	25
VW	PASSAT (3C2) / 2.0 TDI	100 kW 1968 cc	03.2005-	132128	25
VW	PASSAT (3C2) / 2.0 TDI	100 kW 1968 cc	03.2005-	132129	25
VW	PASSAT (3C2) / 2.0 TDI	100 kW 1968 cc (CBAA)	03.2005-	132106	24
VW	PASSAT (3C2) / 2.0 TDI	103 kW 1968 cc	03.2005-	132129	25
VW	PASSAT (3C2) / 2.0 TDI	103 kW 1968 cc (BMP)	03.2005-	132106	24
VW	PASSAT (3C2) / 2.0 TDI	120 kW 1968 cc	08.2005-	132129	25
VW	PASSAT (3C2) / 2.0 TDI	120 kW 1968 cc (BUZ)	08.2005-	132106	24
VW	PASSAT (3C2) / 2.0 TDI	125 kW 1968 cc	08.2005-	132129	25
VW	PASSAT (3C2) / 2.0 TDI	125 kW 1968 cc (CBBB)	08.2005-	132106	24
VW	PASSAT (3C2) / 2.0 TDI	81 kW 1968 cc (CBDC)	11.2008-	132129	25
VW	PASSAT (3C2) / 2.0 TDI	88 kW 1968 cc (BWV)	11.2005-	132129	25
VW	PASSAT (3C2) / 2.0 TDI	90 kW 1968 cc (BVE)	08.2005-07.2006	132129	25
VW	PASSAT (3C2) / 2.0 TDI 16V	103 kW 1968 cc	03.2005-	132128	25
VW	PASSAT (3C2) / 2.0 TDI 16V	103 kW 1968 cc	03.2005-	132129	25
VW	PASSAT (3C2) / 2.0 TDI 16V	103 kW 1968 cc (CBAB)	03.2005-	132106	24
VW	PASSAT (3C2) / 2.0 TDI 16V 4mot.	103 kW 1968 cc	03.2005-	132128	25
VW	PASSAT (3C2) / 2.0 TDI 16V 4mot.	103 kW 1968 cc	03.2005-	132129	25
VW	PASSAT (3C2) / 2.0 TDI 16V 4mot.	103 kW 1968 cc (CBAB)	03.2005-	132106	24
VW	PASSAT (3C2) / 2.0 TDI 4mot.	103 kW 1968 cc	03.2005-	132129	25
VW	PASSAT (3C2) / 2.0 TDI 4mot.	103 kW 1968 cc (BMP)	03.2005-	132106	24
VW	PASSAT (3C2) / 2.0 TDI 4mot.	125 kW 1968 cc (CBBB)	05.2009-	132129	25
VW	PASSAT CC / 2.0 BlueTDI	105 kW 1968 cc (CBAC)	05.2009-11.2010	132129	25
VW	PASSAT CC / 2.0 TDI	100 kW 1968 cc	06.2008-05.2011	132129	25
VW	PASSAT CC / 2.0 TDI	100 kW 1968 cc (CBAA)	06.2008-05.2011	132106	24
VW	PASSAT CC / 2.0 TDI	103 kW 1968 cc	06.2008-	132129	25
VW	PASSAT CC / 2.0 TDI	103 kW 1968 cc (CBAB)	06.2008-	132106	24
VW	PASSAT CC / 2.0 TDI	125 kW 1968 cc (CBBB)	06.2008-	132129	25
VW	PASSAT CC / 2.0 TDI 4mot.	103 kW 1968 cc	08.2009-	132129	25
VW	PASSAT CC / 2.0 TDI 4mot.	103 kW 1968 cc (CBAB)	08.2009-	132106	24
VW	PASSAT CC / 2.0 TDI 4mot.	125 kW 1968 cc (CBBB)	11.2009-	132129	25
VW	PASSAT Stufenh. 2.0 TDI 16V 4mot.	103 kW 1968 cc	03.2005-	132106	24
VW	PASSAT Stufenh. 2.0 TDI 16V 4mot.	103 kW 1968 cc	03.2005-	132128	25
VW	PASSAT Stufenh. 2.0 TDI 16V 4mot.	103 kW 1968 cc	03.2005-	132129	25
VW	PASSAT Stufenh. 2.0 TDI 4mot.	103 kW 1968 cc	03.2005-	132129	25
VW	PASSAT Stufenh. (32B) / 1.6 TD	51 kW 1588 cc	01.1985-03.1988	132062	23
VW	PASSAT Stufenh. (32B) / 1.6 TD	51 kW 1588 cc	01.1985-03.1988	132063	23
VW	PASSAT Stufenh. (3B3) / 2.0 TDI	100 kW 1968 cc	12.2003-05.2005	132105	24
VW	PASSAT Stufenh. (3C2) / 1.6 TDI	77 kW 1598 cc	08.2009-	132106	24
VW	PASSAT Stufenh. (3C2) / 1.6 TDI	77 kW 1598 cc	08.2009-	132129	25
VW	PASSAT Stufenh. (3C2) / 1.9 TDI	77 kW 1896 cc	03.2005-	132104	24
VW	PASSAT Stufenh. (3C2) / 1.9 TDI	77 kW 1896 cc	03.2005-	132106	24
VW	PASSAT Stufenh. (3C2) / 1.9 TDI	77 kW 1896 cc	03.2005-	132107	24
VW	PASSAT Stufenh. (3C2) / 1.9 TDI	77 kW 1896 cc	03.2005-	132128	25
VW	PASSAT Stufenh. (3C2) / 1.9 TDI	77 kW 1896 cc	03.2005-	132129	25
VW	PASSAT Stufenh. (3C2) / 2.0 BlueTDI	105 kW 1968 cc	01.2009-	132129	25
VW	PASSAT Stufenh. (3C2) / 2.0 TDI	100 kW 1968 cc	03.2005-	132106	24
VW	PASSAT Stufenh. (3C2) / 2.0 TDI	100 kW 1968 cc	03.2005-	132128	25
VW	PASSAT Stufenh. (3C2) / 2.0 TDI	100 kW 1968 cc	03.2005-	132129	25
VW	PASSAT Stufenh. (3C2) / 2.0 TDI	103 kW 1968 cc	03.2005-	132106	24
VW	PASSAT Stufenh. (3C2) / 2.0 TDI	103 kW 1968 cc	03.2005-	132129	25
VW	PASSAT Stufenh. (3C2) / 2.0 TDI	120 kW 1968 cc	08.2005-	132106	24
VW	PASSAT Stufenh. (3C2) / 2.0 TDI	120 kW 1968 cc	08.2005-	132129	25
VW	PASSAT Stufenh. (3C2) / 2.0 TDI	125 kW 1968 cc	08.2005-	132106	24
VW	PASSAT Stufenh. (3C2) / 2.0 TDI	125 kW 1968 cc	08.2005-	132129	25



Modell
Model

Motor
Engine



Baujahr
Construction year

HÜCO-NO. Seite
Page

	Modell Model	Motor Engine	Baujahr Construction year	HÜCO-NO.	Seite Page
VW	PASSAT Stufenh. (3C2) / 2.0 TDI	81 kW 1968 cc	11.2008-	132129	25
VW	PASSAT Stufenh. (3C2) / 2.0 TDI	88 kW 1968 cc	11.2005-	132129	25
VW	PASSAT Stufenh. (3C2) / 2.0 TDI	90 kW 1968 cc	08.2005-07.2006	132129	25
VW	PASSAT Stufenh. (3C2) / 2.0 TDI 16V	103 kW 1968 cc	03.2005-	132106	24
VW	PASSAT Stufenh. (3C2) / 2.0 TDI 16V	103 kW 1968 cc	03.2005-	132128	25
VW	PASSAT Stufenh. (3C2) / 2.0 TDI 16V	103 kW 1968 cc	03.2005-	132129	25
VW	PASSAT Stufenh. (3C2) / 2.0 TDI 4mot.	125 kW 1968 cc	05.2009-	132129	25
VW	PASSAT Stufenh. 2.0 TDI 4mot.	103 kW 1968 cc	03.2005-	132106	24
VW	PASSAT Vari. 2.0 TDI 16V 4mot.	103 kW 1968 cc	08.2005-	132128	25
VW	PASSAT Vari. 2.0 TDI 16V 4mot.	103 kW 1968 cc	08.2005-	132129	25
VW	PASSAT Vari. 2.0 TDI 16V 4mot.	103 kW 1968 cc (BKP)	08.2005-	132106	24
VW	PASSAT Vari. (32B) / 1.6 D	40 kW 1588 cc	08.1980-03.1988	132062	23
VW	PASSAT Vari. (32B) / 1.6 D	40 kW 1588 cc	08.1980-03.1988	132063	23
VW	PASSAT Vari. (32B) / 1.6 TD	51 kW 1588 cc	04.1982-03.1988	132062	23
VW	PASSAT Vari. (32B) / 1.6 TD	51 kW 1588 cc	04.1982-03.1988	132063	23
VW	PASSAT Vari. (33) / 1.5 D	37 kW 1471 cc	02.1977-07.1980	132063	23
VW	PASSAT Vari. (33) / 1.5 D	37 kW 1588 cc	02.1977-07.1980	132062	23
VW	PASSAT Vari. (33) / 1.6 D	40 kW 1588 cc	02.1979-07.1980	132063	23
VW	PASSAT Vari. (33) / 1.6 D	40 kW 1994 cc	02.1979-07.1980	132062	23
VW	PASSAT Vari. (365) / 1.6 TDI	77 kW 1598 cc	08.2010-	132129	25
VW	PASSAT Vari. (365) / 1.6 TDI	77 kW 1598 cc (CAYC)	08.2010-	132106	24
VW	PASSAT Vari. (365) / 2.0 TDI	103 kW 1968 cc	08.2010-	132129	25
VW	PASSAT Vari. (365) / 2.0 TDI	103 kW 1968 cc (CFFB)	08.2010-	132106	24
VW	PASSAT Vari. (365) / 2.0 TDI	125 kW 1968 cc	08.2010-	132129	25
VW	PASSAT Vari. (365) / 2.0 TDI 4mot.	103 kW 1968 cc	08.2010-	132129	25
VW	PASSAT Vari. (365) / 2.0 TDI 4mot.	103 kW 1968 cc (CFFB)	08.2010-	132106	24
VW	PASSAT Vari. (365) / 2.0 TDI 4mot.	125 kW 1968 cc	08.2010-	132129	25
VW	PASSAT Vari. (3A5, 35l) / 1.6 TD	59 kW 1588 cc	08.1988-09.1993	132062	23
VW	PASSAT Vari. (3A5, 35l) / 1.6 TD	59 kW 1588 cc	08.1988-09.1993	132063	23
VW	PASSAT Vari. (3A5, 35l) / 1.6 TD	59 kW 1588 cc (SB)	08.1988-09.1993	132061	23
VW	PASSAT Vari. (3A5, 35l) / 1.9 D	50 kW 1588 cc	05.1989-10.1993	132062	23
VW	PASSAT Vari. (3A5, 35l) / 1.9 D	50 kW 1896 cc	05.1989-10.1993	132063	23
VW	PASSAT Vari. (3A5, 35l) / 1.9 TD	55 kW 1896 cc (AAZ)	03.1991-05.1997	132062	23
VW	PASSAT Vari. (3B6) / 2.0 TDI	100 kW 1968 cc (BGW)	12.2003-05.2005	132105	24
VW	PASSAT Vari. (3C5) / 1.6 TDI	77 kW 1598 cc	08.2009-	132129	25
VW	PASSAT Vari. (3C5) / 1.6 TDI	77 kW 1598 cc (CAYC)	08.2009-	132106	24
VW	PASSAT Vari. (3C5) / 1.9 TDI	77 kW 1896 cc	08.2005-	132106	24
VW	PASSAT Vari. (3C5) / 1.9 TDI	77 kW 1896 cc	08.2005-	132107	24
VW	PASSAT Vari. (3C5) / 1.9 TDI	77 kW 1896 cc	08.2005-	132128	25
VW	PASSAT Vari. (3C5) / 1.9 TDI	77 kW 1896 cc	08.2005-	132129	25
VW	PASSAT Vari. (3C5) / 1.9 TDI	77 kW 1896 cc (BKC)	08.2005-	132104	24
VW	PASSAT Vari. (3C5) / 2.0 BlueTDI	105 kW 1968 cc (CBAC)	01.2009-	132129	25
VW	PASSAT Vari. (3C5) / 2.0 TDI	100 kW 1968 cc	08.2005-	132128	25
VW	PASSAT Vari. (3C5) / 2.0 TDI	100 kW 1968 cc	08.2005-	132129	25
VW	PASSAT Vari. (3C5) / 2.0 TDI	100 kW 1968 cc (CBAA)	08.2005-	132106	24
VW	PASSAT Vari. (3C5) / 2.0 TDI	103 kW 1968 cc	08.2005-	132129	25
VW	PASSAT Vari. (3C5) / 2.0 TDI	103 kW 1968 cc (BMP)	08.2005-	132106	24
VW	PASSAT Vari. (3C5) / 2.0 TDi	120 kW 1968 cc	08.2005-	132129	25
VW	PASSAT Vari. (3C5) / 2.0 TDi	120 kW 1968 cc (BUZ)	08.2005-	132106	24
VW	PASSAT Vari. (3C5) / 2.0 TDI	125 kW 1968 cc	08.2005-	132129	25
VW	PASSAT Vari. (3C5) / 2.0 TDI	125 kW 1968 cc (CBBB)	08.2005-	132106	24
VW	PASSAT Vari. (3C5) / 2.0 TDI	81 kW 1968 cc (CBDC)	11.2008-	132129	25
VW	PASSAT Vari. (3C5) / 2.0 TDI	88 kW 1905 cc	11.2005-	132129	25
VW	PASSAT Vari. (3C5) / 2.0 TDI	90 kW 1968 cc (BVE)	08.2005-	132129	25
VW	PASSAT Vari. (3C5) / 2.0 TDI 16V	103 kW 1968 cc	08.2005-	132128	25
VW	PASSAT Vari. (3C5) / 2.0 TDI 16V	103 kW 1968 cc	08.2005-	132129	25
VW	PASSAT Vari. (3C5) / 2.0 TDI 16V	103 kW 1968 cc (CBAB)	08.2005-	132106	24
VW	PASSAT Vari. (3C5) / 2.0 TDI 4mot.	103 kW 1968 cc	08.2005-	132129	25
VW	PASSAT Vari. (3C5) / 2.0 TDI 4mot.	103 kW 1968 cc (BMP)	08.2005-	132106	24
VW	PASSAT Vari. (3C5) / 2.0 TDI 4mot.	125 kW 1968 cc (CBBB)	05.2009-	132129	25
VW	POLO (6N2) / 1.4 TDI	55 kW 1422 cc (AMF)	10.1999-09.2001	132128	25
VW	POLO (6N2) / 1.4 TDi	66 kW 1422 cc (ATL)	01.2000-10.2000	132128	25
VW	POLO (6R_) / 1.6 TDI	66 kW 1598 cc (CAYB)	06.2009-	132106	24
VW	POLO (6R_) / 1.6 TDI	77 kW 1598 cc	06.2009-	132129	25
VW	POLO (6R_) / 1.6 TDI	77 kW 1598 cc (CAYC)	06.2009-	132106	24
VW	POLO (86C, 80) / 1.3 D	33 kW 1272 cc (MN)	08.1986-07.1990	132061	23
VW	POLO (9N_) / 1.4 TDI	55 kW 1422 cc (AMF)	10.2001-06.2005	132128	25



Modell
Model

Motor
Engine



Baujahr
Construction year

HÜCO-NO. Seite
Page

	Modell Model	Motor Engine	Baujahr Construction year	HÜCO-NO.	Seite Page
VW	POLO (9N_) / 1.4 TDI	59 kW 1422 cc (BMS)	04.2005-	132128	25
VW	POLO (9N_) / 1.9 TDI	74 kW 1896 cc	10.2001-	132128	25
VW	POLO (9N_) / 1.9 TDI	74 kW 1896 cc (AXR)	10.2001-	132106	24
VW	POLO (9N_) / 1.9 TDI	96 kW 1896 cc (ASZ)	11.2003-	132105	24
VW	POLO CLASSIC (86C, 80) / 1.3 D	33 kW 1272 cc (MN)	08.1986-12.1988	132061	23
VW	POLO Coupe (86C, 80) / 1.3 D	33 kW 1272 cc (MN)	08.1986-08.1990	132061	23
VW	QUANTUM Kombi (32B) / 1.6 D	40 kW 1588 cc	08.1980-03.1988	132062	23
VW	QUANTUM Kombi (32B) / 1.6 D	40 kW 1588 cc	08.1980-03.1988	132063	23
VW	QUANTUM Kombi (32B) / 1.6 TD	51 kW 1588 cc	04.1982-03.1988	132062	23
VW	QUANTUM Kombi (32B) / 1.6 TD	51 kW 1588 cc	04.1982-03.1988	132063	23
VW	RABBIT I (17) / 1.5 D	37 kW 1471 cc	08.1976-07.1980	132062	23
VW	RABBIT I (17) / 1.5 D	37 kW 1471 cc	08.1976-07.1980	132063	23
VW	RABBIT I (17) / 1.6 D	40 kW 1588 cc	08.1980-07.1983	132061	23
VW	RABBIT I (17) / 1.6 D	40 kW 1588 cc	08.1980-07.1983	132062	23
VW	RABBIT I (17) / 1.6 D	40 kW 1588 cc	08.1980-07.1983	132063	23
VW	RABBIT I (17) / 1.6 TD	51 kW 1588 cc	03.1982-07.1983	132061	23
VW	RABBIT I (17) / 1.6 TD	51 kW 1588 cc	03.1982-07.1983	132062	23
VW	RABBIT I (17) / 1.6 TD	51 kW 1588 cc	03.1982-07.1983	132063	23
VW	RABBIT I Cabriolet (155) / 1.8	66 kW 1781 cc	08.1983-09.1992	132020	16
VW	RABBIT I Cabriolet (155) / 1.8	66 kW 1781 cc	08.1983-09.1992	132023	17
VW	RABBIT I Cabriolet (155) / 1.8	70 kW 1781 cc	08.1983-04.1993	132020	16
VW	RABBIT I Cabriolet (155) / 1.8	70 kW 1781 cc	08.1983-04.1993	132023	17
VW	RABBIT I Cabriolet (155) / 1.8	72 kW 1781 cc	08.1989-03.1993	132020	16
VW	RABBIT I Cabriolet (155) / 1.8	72 kW 1781 cc	08.1989-03.1993	132023	17
VW	RABBIT I Cabriolet (155) / 1.8	82 kW 1781 cc	08.1982-12.1989	132020	16
VW	RABBIT I Cabriolet (155) / 1.8	82 kW 1781 cc	08.1982-12.1989	132023	17
VW	RABBIT V (1K1) / 1.9 TDI	66 kW 1896 cc	05.2004-	132106	24
VW	RABBIT V (1K1) / 1.9 TDI	66 kW 1896 cc	05.2004-	132128	25
VW	RABBIT V (1K1) / 1.9 TDI	77 kW 1896 cc	10.2003-	132104	24
VW	RABBIT V (1K1) / 1.9 TDI	77 kW 1896 cc	10.2003-	132106	24
VW	RABBIT V (1K1) / 1.9 TDI	77 kW 1896 cc	10.2003-	132107	24
VW	RABBIT V (1K1) / 1.9 TDI	77 kW 1896 cc	10.2003-	132128	25
VW	RABBIT V (1K1) / 1.9 TDI	77 kW 1896 cc	10.2003-	132129	25
VW	RABBIT V (1K1) / 1.9 TDI 4mot.	77 kW 1896 cc	08.2004-	132104	24
VW	RABBIT V (1K1) / 1.9 TDI 4mot.	77 kW 1896 cc	08.2004-	132106	24
VW	RABBIT V (1K1) / 1.9 TDI 4mot.	77 kW 1896 cc	08.2004-	132107	24
VW	RABBIT V (1K1) / 1.9 TDI 4mot.	77 kW 1896 cc	08.2004-	132128	25
VW	RABBIT V (1K1) / 1.9 TDI 4mot.	77 kW 1896 cc	08.2004-	132129	25
VW	RABBIT V (1K1) / 2.0 SDI	55 kW 1968 cc	01.2004-	132128	25
VW	RABBIT V (1K1) / 2.0 TDI	100 kW 1968 cc	10.2003-	132104	24
VW	RABBIT V (1K1) / 2.0 TDI	100 kW 1968 cc	10.2003-	132106	24
VW	RABBIT V (1K1) / 2.0 TDI	100 kW 1968 cc	10.2003-	132128	25
VW	RABBIT V (1K1) / 2.0 TDI	100 kW 1968 cc	10.2003-	132129	25
VW	RABBIT V (1K1) / 2.0 TDI	103 kW 1968 cc	12.2004-	132106	24
VW	RABBIT V (1K1) / 2.0 TDI	103 kW 1968 cc	12.2004-	132128	25
VW	RABBIT V (1K1) / 2.0 TDI	125 kW 1968 cc	11.2005-	132106	24
VW	RABBIT V (1K1) / 2.0 TDI 16V	103 kW 1968 cc	10.2003-	132104	24
VW	RABBIT V (1K1) / 2.0 TDI 16V	103 kW 1968 cc	10.2003-	132106	24
VW	RABBIT V (1K1) / 2.0 TDI 16V	103 kW 1968 cc	10.2003-	132107	24
VW	RABBIT V (1K1) / 2.0 TDI 16V	103 kW 1968 cc	10.2003-	132128	25
VW	RABBIT V (1K1) / 2.0 TDI 16V	103 kW 1968 cc	10.2003-	132129	25
VW	RABBIT V (1K1) / 2.0 TDI 16V 4mot.	103 kW 1968 cc	08.2004-	132104	24
VW	RABBIT V (1K1) / 2.0 TDI 16V 4mot.	103 kW 1968 cc	08.2004-	132106	24
VW	RABBIT V (1K1) / 2.0 TDI 16V 4mot.	103 kW 1968 cc	08.2004-	132107	24
VW	RABBIT V (1K1) / 2.0 TDI 16V 4mot.	103 kW 1968 cc	08.2004-	132128	25
VW	RABBIT V (1K1) / 2.0 TDI 16V 4mot.	103 kW 1968 cc	08.2004-	132129	25
VW	RABBIT V (1K1) / 2.0 TDI 4mot.	103 kW 1968 cc	08.2004-	132106	24
VW	RABBIT V (1K1) / 2.0 TDI 4mot.	103 kW 1968 cc	08.2004-	132128	25
VW	SANTANA (32B) / 1.3	40 kW 1272 cc	08.1980-07.1983	132090	24
VW	SANTANA (32B) / 1.6 D	40 kW 1588 cc	08.1980-03.1988	132062	23
VW	SANTANA (32B) / 1.6 D	40 kW 1588 cc	08.1980-03.1988	132063	23
VW	SANTANA (32B) / 1.6 D	40 kW 1588 cc	08.1981-12.1984	132063	23
VW	SANTANA (32B) / 1.6 D	40 kW 1896 cc	08.1981-12.1984	132062	23
VW	SANTANA (32B) / 1.6 TD	51 kW 1588 cc	04.1982-03.1988	132062	23
VW	SANTANA (32B) / 1.6 TD	51 kW 1588 cc	04.1982-03.1988	132063	23
VW	SANTANA (32B) / 1.6 TD	51 kW 1588 cc	12.1981-12.1984	132063	23
VW	SANTANA (32B) / 1.6 TD	51 kW 1968 cc	12.1981-12.1984	132062	23



Modell
Model

Motor
Engine



Baujahr
Construction year

HÜCO-NO. Seite
Page

VW	SANTANA (32B) / 1.6 TD	59 kW 1588 cc	05.1986-03.1988	132062	23
VW	SANTANA (32B) / 1.6 TD	59 kW 1588 cc	05.1986-03.1988	132063	23
VW	SANTANA Stufenh. (32B) / 1.6 TD	51 kW 1588 cc	01.1985-03.1988	132062	23
VW	SANTANA Stufenh. (32B) / 1.6 TD	51 kW 1588 cc	01.1985-03.1988	132063	23
VW	SAVEIRO Pritsche / 1.6 D	59 kW 1588 cc (SB)	08.1991-07.1996	132061	23
VW	SCIROCCO (137) / 2.0 TDI	103 kW 1968 cc	08.2008-	132128	25
VW	SCIROCCO (137) / 2.0 TDI	103 kW 1968 cc (CBDB)	08.2008-	132106	24
VW	SCIROCCO (137) / 2.0 TDI	125 kW 1968 cc (CBBB)	05.2009-	132129	25
VW	SHARAN (7M8, 7M9, 7M6) / 1.9 TDI	96 kW 1896 cc (ASZ)	11.2002-03.2010	132105	24
VW	SHARAN (7N) / 2.0 TDI	103 kW 1968 cc	05.2010-	132129	25
VW	SHARAN (7N) / 2.0 TDI	103 kW 1968 cc (CFFB)	05.2010-	132106	24
VW	SHARAN (7N) / 2.0 TDI	125 kW 1968 cc	08.2010-	132129	25
VW	SHARAN (7N) / 2.0 TDI 4mot.	103 kW 1968 cc	05.2011-	132129	25
VW	SHARAN (7N) / 2.0 TDI 4mot.	103 kW 1968 cc (CFFB)	05.2011-	132106	24
VW	TIGUAN (5N_) / 2.0 TDI	103 kW 1968 cc	03.2008-	132129	25
VW	TIGUAN (5N_) / 2.0 TDI	103 kW 1968 cc (CBAB)	03.2008-	132106	24
VW	TIGUAN (5N_) / 2.0 TDI 4mot.	100 kW 1968 cc	11.2007-	132129	25
VW	TIGUAN (5N_) / 2.0 TDI 4mot.	100 kW 1968 cc (CBAA)	11.2007-	132106	24
VW	TIGUAN (5N_) / 2.0 TDI 4mot.	103 kW 1968 cc	09.2007-	132129	25
VW	TIGUAN (5N_) / 2.0 TDI 4mot.	103 kW 1968 cc (CBAB)	09.2007-	132106	24
VW	TIGUAN (5N_) / 2.0 TDI 4mot.	120 kW 2499 cc	02.2008-08.2009	132045	23
VW	TIGUAN (5N_) / 2.0 TDI 4mot.	125 kW 1968 cc (CBBB)	09.2007-	132129	25
VW	TOUAREG (7P5) / 4.2 V8 TDI	250 kW 4134 cc (CKDA)	01.2010-	132129	25
VW	TOURAN (1T1, 1T2, 1T3) / 1.6 TDI	66 kW 1598 cc (CAYB)	05.2010-	132106	24
VW	TOURAN (1T1, 1T2, 1T3) / 1.6 TDI	77 kW 1598 cc	05.2010-	132129	25
VW	TOURAN (1T1, 1T2, 1T3) / 1.6 TDI	77 kW 1598 cc (CAYC)	05.2010-	132106	24
VW	TOURAN (1T1, 1T2, 1T3) / 1.9 TDI	66 kW 1896 cc	11.2004-05.2010	132128	25
VW	TOURAN (1T1, 1T2, 1T3) / 1.9 TDI	66 kW 1896 cc (BRU)	11.2004-05.2010	132106	24
VW	TOURAN (1T1, 1T2, 1T3) / 1.9 TDI	74 kW 1896 cc (AVQ)	02.2003-	132128	25
VW	TOURAN (1T1, 1T2, 1T3) / 1.9 TDI	77 kW 1896 cc	08.2003-05.2010	132106	24
VW	TOURAN (1T1, 1T2, 1T3) / 1.9 TDI	77 kW 1896 cc	08.2003-05.2010	132107	24
VW	TOURAN (1T1, 1T2, 1T3) / 1.9 TDI	77 kW 1896 cc	08.2003-05.2010	132128	25
VW	TOURAN (1T1, 1T2, 1T3) / 1.9 TDI	77 kW 1896 cc	08.2003-05.2010	132129	25
VW	TOURAN (1T1, 1T2, 1T3) / 1.9 TDI	77 kW 1896 cc (BKC)	08.2003-05.2010	132104	24
VW	TOURAN (1T1, 1T2, 1T3) / 2.0 TDI	100 kW 1968 cc	02.2003-05.2010	132106	24
VW	TOURAN (1T1, 1T2, 1T3) / 2.0 TDI	100 kW 1968 cc	02.2003-05.2010	132128	25
VW	TOURAN (1T1, 1T2, 1T3) / 2.0 TDI	100 kW 1968 cc	02.2003-05.2010	132129	25
VW	TOURAN (1T1, 1T2, 1T3) / 2.0 TDI	100 kW 1968 cc (AZV)	02.2003-05.2010	132104	24
VW	TOURAN (1T1, 1T2, 1T3) / 2.0 TDI	103 kW 1968 cc	12.2005-05.2010	132128	25
VW	TOURAN (1T1, 1T2, 1T3) / 2.0 TDI	103 kW 1968 cc (BMM)	12.2005-05.2010	132106	24
VW	TOURAN (1T1, 1T2, 1T3) / 2.0 TDI	125 kW 1968 cc (BMN)	12.2005-	132106	24
VW	TOURAN (1T1, 1T2, 1T3) / 2.0 TDI	81 kW 1968 cc (CLCA)	05.2010-	132128	25
VW	TOURAN (1T1, 1T2, 1T3) / 2.0 TDI 16V	103 kW 1968 cc	08.2003-	132106	24
VW	TOURAN (1T1, 1T2, 1T3) / 2.0 TDI 16V	103 kW 1968 cc	08.2003-	132107	24
VW	TOURAN (1T1, 1T2, 1T3) / 2.0 TDI 16V	103 kW 1968 cc	08.2003-	132128	25
VW	TOURAN (1T1, 1T2, 1T3) / 2.0 TDI 16V	103 kW 1968 cc	08.2003-	132129	25
VW	TOURAN (1T1, 1T2, 1T3) / 2.0 TDI 16V	103 kW 1968 cc (BKD)	08.2003-	132104	24
VW	TRANSP. / CARAV. IV Bus / 2.4 D	57 kW 2370 cc	09.1990-04.1998	132062	23
VW	TRANSP. / CARAV. IV Bus / 2.4 D	57 kW 2370 cc	09.1990-04.1998	132063	23
VW	TRANSP. / CARAV. IV Bus / 2.4 D	57 kW 2370 cc (AAB)	09.1990-04.1998	132061	23
VW	TRANSP. / CARAV. IV Bus / 2.5 TDI	75 kW 2461 cc (ACV)	09.1995-04.2003	132061	23
VW	TRANSP. / CARAV. Mk III Bus / 1.6 D	37 kW 1588 cc	01.1981-07.1987	132062	23
VW	TRANSP. / CARAV. Mk III Bus / 1.6 D	37 kW 1588 cc	01.1981-07.1987	132063	23
VW	TRANSP. / CARAV. Mk III Bus / 1.7 D	42 kW 1716 cc	10.1986-07.1992	132061	23
VW	TRANSP. / CARAV. Mk III Bus / 1.7 D	42 kW 1716 cc	10.1986-07.1992	132062	23
VW	TRANSP. / CARAV. Mk III Bus / 1.7 D	42 kW 1716 cc	10.1986-07.1992	132063	23
VW	TRANSP. / CARAV. Mk IV Bus / 2.4 D	57 kW 2370 cc	09.1990-04.1998	132061	23
VW	TRANSP. / CARAV. Mk IV Bus / 2.4 D	57 kW 2370 cc	09.1990-04.1998	132062	23
VW	TRANSP. / CARAV. Mk IV Bus / 2.4 D	57 kW 2370 cc	09.1990-04.1998	132063	23
VW	TRANSP. / CARAV. Mk IV Bus / 2.5 TDI	75 kW 2461 cc	09.1995-04.2003	132061	23
VW	TRANSP. / CARAV. Mk V Bus / 1.9 TDI	62 kW 1896 cc (BRR)	01.2006-11.2009	132129	25
VW	TRANSP. / CARAV. Mk V Bus / 1.9 TDI	63 kW 1896 cc (AXC)	04.2003-11.2009	132129	25
VW	TRANSP. / CARAV. Mk V Bus / 1.9 TDI	75 kW 1896 cc (BRS)	06.2006-11.2009	132129	25
VW	TRANSP. / CARAV. Mk V Bus / 1.9 TDI	77 kW 1896 cc (AXB)	04.2003-11.2009	132129	25
VW	TRANSP. / CARAV. Mk V Bus / 2.0	85 kW 1984 cc (AXA)	11.2003-	132129	25
VW	TRANSP. / CARAV. Mk V Bus / 2.0 TDI	100 kW 1968 cc (CAAE)	05.2010-	132129	25
VW	TRANSP. / CARAV. Mk V Bus / 2.0 TDI	103 kW 1968 cc (CAAC)	09.2009-	132129	25



Modell
Model

Motor
Engine



Baujahr
Construction year

HÜCO-NO. Seite
Page

	Modell Model	Motor Engine	Baujahr Construction year	HÜCO-NO.	Seite Page
VW	TRANSP. / CARAV. Mk V Bus / 2.0 TDI	62 kW 1968 cc (CAAA)	09.2009-	132129	25
VW	TRANSP. / CARAV. Mk V Bus / 2.0 TDI	75 kW 1968 cc (CAAB)	09.2009-	132129	25
VW	TRANSP. / CARAV. V Bus / 1.9 TDI	62 kW 1896 cc	01.2006-11.2009	132129	25
VW	TRANSP. / CARAV. V Bus / 1.9 TDI	63 kW 1896 cc	04.2003-11.2009	132129	25
VW	TRANSP. / CARAV. V Bus / 1.9 TDI	75 kW 1896 cc	06.2006-11.2009	132129	25
VW	TRANSP. / CARAV. V Bus / 1.9 TDI	77 kW 1896 cc	04.2003-11.2009	132129	25
VW	TRANSP. / CARAV. V Bus / 2.0	85 kW 1984 cc	11.2003-	132129	25
VW	TRANSP. / CARAV. V Bus / 2.0 BitDI	132 kW 1968 cc	09.2009-	132129	25
VW	TRANSP. / CARAV. V Bus / 2.0 TDI	100 kW 1968 cc	05.2010-	132129	25
VW	TRANSP. / CARAV. V Bus / 2.0 TDI	103 kW 1968 cc	09.2009-	132129	25
VW	TRANSP. / CARAV. V Bus / 2.0 TDI	62 kW 1968 cc	09.2009-	132129	25
VW	TRANSP. / CARAV. V Bus / 2.0 TDI	75 kW 1968 cc	09.2009-	132129	25
VW	TRANSP. / CARAVELLE III Bus / 1.6 D	37 kW 1588 cc	01.1981-07.1987	132063	23
VW	TRANSP. / CARAVELLE III Bus / 1.6 D	37 kW 1870 cc	01.1981-07.1987	132062	23
VW	TRANSP. / CARAVELLE III Bus / 1.6 TD	51 kW 1589 cc	08.1984-07.1992	132063	23
VW	TRANSP. / CARAVELLE III Bus / 1.6 TD	51 kW 1896 cc	08.1984-07.1992	132062	23
VW	TRANSP. / CARAVELLE III Bus / 1.7 D	42 kW 1716 cc	10.1986-07.1992	132062	23
VW	TRANSP. / CARAVELLE III Bus / 1.7 D	42 kW 1716 cc	10.1986-07.1992	132063	23
VW	TRANSP. / CARAVELLE III Bus / 1.7 D	42 kW 1716 cc (KY)	10.1986-07.1992	132061	23
VW	TRANSP. CARAV. IV Bus / 2.4 D Syncro	57 kW 2370 cc	10.1992-09.1998	132062	23
VW	TRANSP. CARAV. IV Bus / 2.4 D Syncro	57 kW 2370 cc	10.1992-09.1998	132063	23
VW	TRANSP. CARAV. IV Bus / 2.4 D Syncro	57 kW 2370 cc (AAB)	10.1992-09.1998	132061	23
VW	TRANSP. CARAV. IV Bus 2.5 TDI Syncro	75 kW 2461 cc (ACV)	01.1996-04.2003	132061	23
VW	TRANSP. CARAV. Mk V Bus 2.0 BitDI	132 kW 1968 cc (CFCA)	09.2009-	132129	25
VW	TRANSP. CARAV. V Bus 2.0 TDI 4mot.	100 kW 1968 cc	05.2010-	132129	25
VW	TRANSP. CARAV. V Bus 2.0 TDI 4mot.	103 kW 1968 cc	09.2009-	132129	25
VW	TRANSP. CARAVELLE Mk III Bus / 1.6 TD	51 kW 1589 cc	08.1984-07.1992	132063	23
VW	TRANSP. CARAVELLE Mk III Bus 1.6 TD	51 kW 1589 cc	08.1984-07.1992	132062	23
VW	TRANSP. III Bus / 1.6 D	37 kW 1588 cc	01.1981-07.1987	132062	23
VW	TRANSP. III Bus / 1.6 D	37 kW 1588 cc	01.1981-07.1987	132063	23
VW	TRANSP. III Bus / 1.6 TD	51 kW 1589 cc	08.1984-07.1992	132062	23
VW	TRANSP. III Bus / 1.6 TD	51 kW 1589 cc	08.1984-07.1992	132063	23
VW	TRANSP. III Bus / 1.6 TD Syncro	51 kW 1589 cc	03.1986-07.1992	132062	23
VW	TRANSP. III Bus / 1.6 TD Syncro	51 kW 1589 cc	03.1986-07.1992	132063	23
VW	TRANSP. III Bus / 1.7 D	42 kW 1716 cc	10.1986-07.1992	132061	23
VW	TRANSP. III Bus / 1.7 D	42 kW 1716 cc	10.1986-07.1992	132062	23
VW	TRANSP. III Bus / 1.7 D	42 kW 1716 cc	10.1986-07.1992	132063	23
VW	TRANSP. III Kasten / 1.6 D	37 kW 1588 cc	01.1981-07.1987	132063	23
VW	TRANSP. III Kasten / 1.6 D	37 kW 1598 cc	01.1981-07.1987	132062	23
VW	TRANSP. III Kasten / 1.6 TD	51 kW 1589 cc	10.1984-07.1992	132063	23
VW	TRANSP. III Kasten / 1.6 TD	51 kW 1796 cc	10.1984-07.1992	132062	23
VW	TRANSP. III Kasten / 1.6 TD Syncro	51 kW 1589 cc	03.1986-07.1992	132063	23
VW	TRANSP. III Kasten / 1.6 TD Syncro	51 kW 1716 cc	03.1986-07.1992	132062	23
VW	TRANSP. III Kasten / 1.7 D	42 kW 1716 cc	07.1989-07.1992	132062	23
VW	TRANSP. III Kasten / 1.7 D	42 kW 1716 cc	07.1989-07.1992	132063	23
VW	TRANSP. III Kasten / 1.7 D	42 kW 1716 cc (KY)	07.1989-07.1992	132061	23
VW	TRANSP. III Pritsche / 1.6 D	37 kW 1588 cc	01.1981-07.1987	132063	23
VW	TRANSP. III Pritsche / 1.6 D	37 kW 1753 cc	01.1981-07.1987	132062	23
VW	TRANSP. III Pritsche / 1.6 TD	51 kW 1589 cc	10.1984-07.1992	132063	23
VW	TRANSP. III Pritsche / 1.6 TD	51 kW 1968 cc	10.1984-07.1992	132062	23
VW	TRANSP. III Pritsche / 1.6 TD Syncro	51 kW 1589 cc	03.1986-07.1992	132062	23
VW	TRANSP. III Pritsche / 1.6 TD Syncro	51 kW 1589 cc	03.1986-07.1992	132063	23
VW	TRANSP. III Pritsche / 1.7 D	42 kW 1715 cc (KY)	08.1985-07.1987	132061	23
VW	TRANSP. III Pritsche / 1.7 D	42 kW 1716 cc	07.1989-07.1992	132062	23
VW	TRANSP. III Pritsche / 1.7 D	42 kW 1716 cc	07.1989-07.1992	132063	23
VW	TRANSP. III Pritsche / 1.7 D	42 kW 1716 cc (KY)	07.1989-07.1992	132061	23
VW	TRANSP. IV Bus / 2.4 D	57 kW 2370 cc	09.1990-04.1998	132061	23
VW	TRANSP. IV Bus / 2.4 D	57 kW 2370 cc	09.1990-04.1998	132062	23
VW	TRANSP. IV Bus / 2.4 D	57 kW 2370 cc	09.1990-04.1998	132063	23
VW	TRANSP. IV Bus / 2.4 D Syncro	57 kW 2370 cc	10.1992-09.1998	132061	23
VW	TRANSP. IV Bus / 2.4 D Syncro	57 kW 2370 cc	10.1992-09.1998	132062	23
VW	TRANSP. IV Bus / 2.4 D Syncro	57 kW 2370 cc	10.1992-09.1998	132063	23
VW	TRANSP. IV Bus / 2.5 TDI	75 kW 2461 cc	09.1995-04.2003	132061	23
VW	TRANSP. IV Bus / 2.5 TDI Syncro	75 kW 2461 cc	01.1996-04.2003	132061	23
VW	TRANSP. IV Kasten 2.4 D Syncro	57 kW 2370 cc	10.1992-09.1998	132062	23
VW	TRANSP. IV Kasten 2.4 D Syncro	57 kW 2370 cc (AAB)	10.1992-09.1998	132061	23
VW	TRANSP. IV Kasten 2.5 TDI Syncro	75 kW 2461 cc (ACV)	09.1995-04.2003	132061	23



Modell
Model

Motor
Engine



Baujahr
Construction year

HÜCO-NO. Seite
Page

	Modell Model	Motor Engine	Baujahr Construction year	HÜCO-NO.	Seite Page
VW	TRANSP. IV Kasten (70XA) / 2.4 D	57 kW 2370 cc	07.1990-04.1998	132062	23
VW	TRANSP. IV Kasten (70XA) / 2.4 D	57 kW 2370 cc	07.1990-04.1998	132063	23
VW	TRANSP. IV Kasten (70XA) / 2.4 D	57 kW 2370 cc (AAB)	07.1990-04.1998	132061	23
VW	TRANSP. IV Kasten (70XA) / 2.5 TDI	75 kW 2461 cc (ACV)	09.1995-04.2003	132061	23
VW	TRANSP. IV Pritsche 2.4 D Syncro	57 kW 2370 cc	10.1992-09.1998	132062	23
VW	TRANSP. IV Pritsche 2.4 D Syncro	57 kW 2370 cc	10.1992-09.1998	132063	23
VW	TRANSP. IV Pritsche 2.4 D Syncro	57 kW 2370 cc (AAB)	10.1992-09.1998	132061	23
VW	TRANSP. IV Pritsche 2.5 TDI Syncro	75 kW 2461 cc (ACV)	05.1998-04.2003	132061	23
VW	TRANSP. IV Pritsche (70XD) / 2.4 D	57 kW 2370 cc	09.1990-04.1998	132062	23
VW	TRANSP. IV Pritsche (70XD) / 2.4 D	57 kW 2370 cc	09.1990-04.1998	132063	23
VW	TRANSP. IV Pritsche (70XD) / 2.4 D	57 kW 2370 cc (AAB)	09.1990-04.1998	132061	23
VW	TRANSP. IV Pritsche (70XD) / 2.5 TDI	75 kW 2461 cc (ACV)	09.1995-04.2003	132061	23
VW	TRANSP. Mk III / 1.6 TD Syncro	51 kW 1589 cc	03.1986-07.1992	132062	23
VW	TRANSP. Mk III / 1.6 TD Syncro	51 kW 1589 cc	03.1986-07.1992	132063	23
VW	TRANSP. Mk III Kasten / 1.6 D	37 kW 1588 cc	01.1981-07.1987	132062	23
VW	TRANSP. Mk III Kasten / 1.6 D	37 kW 1588 cc	01.1981-07.1987	132063	23
VW	TRANSP. Mk III Kasten / 1.6 TD	51 kW 1589 cc	10.1984-07.1992	132062	23
VW	TRANSP. Mk III Kasten / 1.6 TD	51 kW 1589 cc	10.1984-07.1992	132063	23
VW	TRANSP. Mk III Kasten / 1.6 TD Syn	51 kW 1589 cc	03.1986-07.1992	132062	23
VW	TRANSP. Mk III Kasten / 1.6 TD Syn	51 kW 1589 cc	03.1986-07.1992	132063	23
VW	TRANSP. Mk III Kasten / 1.7 D	42 kW 1716 cc	07.1989-07.1992	132061	23
VW	TRANSP. Mk III Kasten / 1.7 D	42 kW 1716 cc	07.1989-07.1992	132062	23
VW	TRANSP. Mk III Kasten / 1.7 D	42 kW 1716 cc	07.1989-07.1992	132063	23
VW	TRANSP. Mk III Pritsche / 1.6 D	37 kW 1588 cc	01.1981-07.1987	132062	23
VW	TRANSP. Mk III Pritsche / 1.6 D	37 kW 1588 cc	01.1981-07.1987	132063	23
VW	TRANSP. Mk III Pritsche / 1.6 TD	51 kW 1589 cc	10.1984-07.1992	132062	23
VW	TRANSP. Mk III Pritsche / 1.6 TD	51 kW 1589 cc	10.1984-07.1992	132063	23
VW	TRANSP. Mk III Pritsche / 1.7 D	42 kW 1715 cc	08.1985-07.1987	132061	23
VW	TRANSP. Mk III Pritsche / 1.7 D	42 kW 1716 cc	07.1989-07.1992	132061	23
VW	TRANSP. Mk III Pritsche / 1.7 D	42 kW 1716 cc	07.1989-07.1992	132062	23
VW	TRANSP. Mk III Pritsche / 1.7 D	42 kW 1716 cc	07.1989-07.1992	132063	23
VW	TRANSP. Mk IV / 2.4 D	57 kW 2370 cc	09.1990-04.1998	132061	23
VW	TRANSP. Mk IV / 2.4 D	57 kW 2370 cc	09.1990-04.1998	132062	23
VW	TRANSP. Mk IV / 2.4 D	57 kW 2370 cc	09.1990-04.1998	132063	23
VW	TRANSP. Mk IV / 2.4 D Syncro	57 kW 2370 cc	10.1992-09.1998	132061	23
VW	TRANSP. Mk IV / 2.4 D Syncro	57 kW 2370 cc	10.1992-09.1998	132062	23
VW	TRANSP. Mk IV / 2.4 D Syncro	57 kW 2370 cc	10.1992-09.1998	132063	23
VW	TRANSP. Mk IV / 2.5 TDI	75 kW 2461 cc	09.1995-04.2003	132061	23
VW	TRANSP. Mk IV / 2.5 TDI Syncro	75 kW 2461 cc	05.1998-04.2003	132061	23
VW	TRANSP. Mk IV Kasten 2.4 D Syncro	57 kW 2370 cc	10.1992-09.1998	132061	23
VW	TRANSP. Mk IV Kasten 2.4 D Syncro	57 kW 2370 cc	10.1992-09.1998	132062	23
VW	TRANSP. Mk IV Kasten 2.4 D Syncro	57 kW 2370 cc	10.1992-09.1998	132063	23
VW	TRANSP. Mk IV Kasten 2.5 TDI Syncro	75 kW 2461 cc	09.1995-04.2003	132061	23
VW	TRANSP. Mk IV Kasten (70XA) / 2.4 D	57 kW 2370 cc	07.1990-04.1998	132061	23
VW	TRANSP. Mk IV Kasten (70XA) / 2.4 D	57 kW 2370 cc	07.1990-04.1998	132062	23
VW	TRANSP. Mk IV Kasten (70XA) / 2.4 D	57 kW 2370 cc	07.1990-04.1998	132063	23
VW	TRANSP. Mk IV Kasten (70XA) 2.5 TDI	75 kW 2461 cc	09.1995-04.2003	132061	23
VW	TRANSP. Mk V / 1.9 TDI	62 kW 1896 cc (BRR)	01.2006-11.2009	132129	25
VW	TRANSP. Mk V / 1.9 TDI	63 kW 1896 cc (AXC)	04.2003-11.2009	132129	25
VW	TRANSP. Mk V / 1.9 TDI	75 kW 1896 cc (BRS)	06.2006-11.2009	132129	25
VW	TRANSP. Mk V / 1.9 TDI	77 kW 1896 cc (AXB)	04.2003-11.2009	132129	25
VW	TRANSP. Mk V / 2.0	85 kW 1984 cc (AXA)	11.2003-	132129	25
VW	TRANSP. Mk V / 2.0 BitDI	132 kW 1968 cc (CFCA)	09.2009-	132129	25
VW	TRANSP. Mk V / 2.0 BitDI 4mot.	132 kW 1968 cc (CFCA)	09.2009-	132129	25
VW	TRANSP. Mk V / 2.0 TDI	103 kW 1968 cc (CAAC)	09.2009-	132129	25
VW	TRANSP. Mk V / 2.0 TDI	62 kW 1968 cc (CAAA)	09.2009-	132129	25
VW	TRANSP. Mk V / 2.0 TDI	75 kW 1968 cc (CAAB)	09.2009-	132129	25
VW	TRANSP. Mk V / 2.0 TDI 4mot.	103 kW 1968 cc (CAAC)	09.2009-	132129	25
VW	TRANSP. Mk V / 2.0 TDI 4mot.	103 kW 1968 cc (CAAC)	09.2009-	132129	25
VW	TRANSP. Mk V Kasten 2.0 BitDI 4mot.	132 kW 1968 cc (CFCA)	09.2009-	132129	25
VW	TRANSP. Mk V Kasten / 1.9 TDI	62 kW 1896 cc (BRR)	01.2006-11.2009	132129	25
VW	TRANSP. Mk V Kasten / 1.9 TDI	63 kW 1896 cc (AXC)	04.2003-11.2009	132129	25
VW	TRANSP. Mk V Kasten / 1.9 TDI	75 kW 1896 cc (BRS)	06.2006-11.2009	132129	25
VW	TRANSP. Mk V Kasten / 1.9 TDI	77 kW 1896 cc (AXB)	04.2003-11.2009	132129	25
VW	TRANSP. Mk V Kasten / 2.0	85 kW 1984 cc (AXA)	11.2003-	132129	25
VW	TRANSP. Mk V Kasten / 2.0 BitDI	132 kW 1968 cc (CFCA)	09.2009-	132129	25
VW	TRANSP. Mk V Kasten / 2.0 TDI	103 kW 1968 cc (CAAC)	09.2009-	132129	25



Modell
Model

Motor
Engine



Baujahr
Construction year

HÜCO-NO. Seite
Page

	Modell Model	Motor Engine	Baujahr Construction year	HÜCO-NO.	Seite Page
VW	TRANSP. Mk V Kasten / 2.0 TDI	62 kW 1968 cc (CAAA)	09.2009-	132129	25
VW	TRANSP. Mk V Kasten / 2.0 TDI	75 kW 1968 cc (CAAB)	09.2009-	132129	25
VW	TRANSP. T3 Bus / 1.6 D	37 kW 1588 cc	01.1981-07.1987	132062	23
VW	TRANSP. T3 Bus / 1.6 D	37 kW 1588 cc	01.1981-07.1987	132063	23
VW	TRANSP. T3 Bus / 1.6 TD	51 kW 1589 cc	08.1984-07.1992	132062	23
VW	TRANSP. T3 Bus / 1.6 TD	51 kW 1589 cc	08.1984-07.1992	132063	23
VW	TRANSP. T3 Bus / 1.6 TD Syncro	51 kW 1589 cc	03.1986-07.1992	132062	23
VW	TRANSP. T3 Bus / 1.6 TD Syncro	51 kW 1589 cc	03.1986-07.1992	132063	23
VW	TRANSP. T3 Bus / 1.7 D	42 kW 1716 cc	10.1986-07.1992	132061	23
VW	TRANSP. T3 Bus / 1.7 D	42 kW 1716 cc	10.1986-07.1992	132062	23
VW	TRANSP. T3 Bus / 1.7 D	42 kW 1716 cc	10.1986-07.1992	132063	23
VW	TRANSP. T3 Kasten / 1.6 D	37 kW 1588 cc	01.1981-07.1987	132062	23
VW	TRANSP. T3 Kasten / 1.6 D	37 kW 1588 cc	01.1981-07.1987	132063	23
VW	TRANSP. T3 Kasten / 1.6 TD	51 kW 1589 cc	10.1984-07.1992	132062	23
VW	TRANSP. T3 Kasten / 1.6 TD	51 kW 1589 cc	10.1984-07.1992	132063	23
VW	TRANSP. T3 Kasten / 1.6 TD Syncro	51 kW 1589 cc	03.1986-07.1992	132062	23
VW	TRANSP. T3 Kasten / 1.6 TD Syncro	51 kW 1589 cc	03.1986-07.1992	132063	23
VW	TRANSP. T3 Kasten / 1.7 D	42 kW 1716 cc	07.1989-07.1992	132061	23
VW	TRANSP. T3 Kasten / 1.7 D	42 kW 1716 cc	07.1989-07.1992	132062	23
VW	TRANSP. T3 Kasten / 1.7 D	42 kW 1716 cc	07.1989-07.1992	132063	23
VW	TRANSP. T3 Pritsche / 1.6 D	37 kW 1588 cc	01.1981-07.1987	132062	23
VW	TRANSP. T3 Pritsche / 1.6 D	37 kW 1588 cc	01.1981-07.1987	132063	23
VW	TRANSP. T3 Pritsche / 1.6 TD	51 kW 1589 cc	10.1984-07.1992	132062	23
VW	TRANSP. T3 Pritsche / 1.6 TD	51 kW 1589 cc	10.1984-07.1992	132063	23
VW	TRANSP. T3 Pritsche / 1.6 TD Syncro	51 kW 1589 cc	03.1986-07.1992	132062	23
VW	TRANSP. T3 Pritsche / 1.6 TD Syncro	51 kW 1589 cc	03.1986-07.1992	132063	23
VW	TRANSP. T3 Pritsche / 1.7 D	42 kW 1715 cc	08.1985-07.1987	132061	23
VW	TRANSP. T3 Pritsche / 1.7 D	42 kW 1716 cc	07.1989-07.1992	132061	23
VW	TRANSP. T3 Pritsche / 1.7 D	42 kW 1716 cc	07.1989-07.1992	132062	23
VW	TRANSP. T3 Pritsche / 1.7 D	42 kW 1716 cc	07.1989-07.1992	132063	23
VW	TRANSP. T4 Bus / 2.4 D	57 kW 2370 cc	09.1990-04.1998	132061	23
VW	TRANSP. T4 Bus / 2.4 D	57 kW 2370 cc	09.1990-04.1998	132062	23
VW	TRANSP. T4 Bus / 2.4 D	57 kW 2370 cc	09.1990-04.1998	132063	23
VW	TRANSP. T4 Bus / 2.4 D Syncro	57 kW 2370 cc	10.1992-09.1998	132061	23
VW	TRANSP. T4 Bus / 2.4 D Syncro	57 kW 2370 cc	10.1992-09.1998	132062	23
VW	TRANSP. T4 Bus / 2.4 D Syncro	57 kW 2370 cc	10.1992-09.1998	132063	23
VW	TRANSP. T4 Bus / 2.5 TDI	75 kW 2461 cc	09.1995-04.2003	132061	23
VW	TRANSP. T4 Bus / 2.5 TDI Syncro	75 kW 2461 cc	01.1996-04.2003	132061	23
VW	TRANSP. T4 Kasten 2.4 D Syncro	57 kW 2370 cc	10.1992-09.1998	132061	23
VW	TRANSP. T4 Kasten 2.4 D Syncro	57 kW 2370 cc	10.1992-09.1998	132062	23
VW	TRANSP. T4 Kasten 2.4 D Syncro	57 kW 2370 cc	10.1992-09.1998	132063	23
VW	TRANSP. T4 Kasten 2.5 TDI Syncro	75 kW 2461 cc	09.1995-04.2003	132061	23
VW	TRANSP. T4 Kasten (70XA) / 2.4 D	57 kW 2370 cc	07.1990-04.1998	132061	23
VW	TRANSP. T4 Kasten (70XA) / 2.4 D	57 kW 2370 cc	07.1990-04.1998	132062	23
VW	TRANSP. T4 Kasten (70XA) / 2.4 D	57 kW 2370 cc	07.1990-04.1998	132063	23
VW	TRANSP. T4 Kasten (70XA) / 2.5 TDI	75 kW 2461 cc	09.1995-04.2003	132061	23
VW	TRANSP. T4 Pritsche 2.4 D Syncro	57 kW 2370 cc	10.1992-09.1998	132061	23
VW	TRANSP. T4 Pritsche 2.4 D Syncro	57 kW 2370 cc	10.1992-09.1998	132062	23
VW	TRANSP. T4 Pritsche 2.4 D Syncro	57 kW 2370 cc	10.1992-09.1998	132063	23
VW	TRANSP. T4 Pritsche 2.5 TDI Syncro	75 kW 2461 cc	05.1998-04.2003	132061	23
VW	TRANSP. T4 Pritsche (70XD) / 2.4 D	57 kW 2370 cc	09.1990-04.1998	132061	23
VW	TRANSP. T4 Pritsche (70XD) / 2.4 D	57 kW 2370 cc	09.1990-04.1998	132062	23
VW	TRANSP. T4 Pritsche (70XD) / 2.4 D	57 kW 2370 cc	09.1990-04.1998	132063	23
VW	TRANSP. T4 Pritsche (70XD) / 2.5 TDI	75 kW 2461 cc	09.1995-04.2003	132061	23
VW	TRANSP. T5 / 1.9 TDI	62 kW 1896 cc	01.2006-11.2009	132129	25
VW	TRANSP. T5 / 1.9 TDI	63 kW 1896 cc	04.2003-11.2009	132129	25
VW	TRANSP. T5 / 1.9 TDI	75 kW 1896 cc	06.2006-11.2009	132129	25
VW	TRANSP. T5 / 1.9 TDI	77 kW 1896 cc	04.2003-11.2009	132129	25
VW	TRANSP. T5 / 2.0	85 kW 1984 cc	11.2003-	132129	25
VW	TRANSP. T5 / 2.0 BitDI	132 kW 1968 cc	09.2009-	132129	25
VW	TRANSP. T5 / 2.0 BitDI 4mot.	132 kW 1968 cc	09.2009-	132129	25
VW	TRANSP. T5 / 2.0 BitDI 4mot.	132 kW 1968 cc	09.2009-	132129	25
VW	TRANSP. T5 / 2.0 TDI	103 kW 1968 cc	09.2009-	132129	25
VW	TRANSP. T5 / 2.0 TDI	62 kW 1968 cc	09.2009-	132129	25
VW	TRANSP. T5 / 2.0 TDI	75 kW 1968 cc	09.2009-	132129	25
VW	TRANSP. T5 / 2.0 TDI 4mot.	103 kW 1968 cc	09.2009-	132129	25
VW	TRANSP. T5 Bus / 1.9 TDI	62 kW 1896 cc	01.2006-11.2009	132129	25

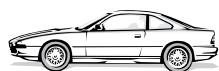

Modell
Model

Motor
Engine



Baujahr
Construction year

HÜCO-NO. Seite
Page

	Modell Model	Motor Engine	Baujahr Construction year	HÜCO-NO.	Seite Page
VW	TRANSP. T5 Bus / 1.9 TDI	63 kW 1896 cc	04.2003-11.2009	132129	25
VW	TRANSP. T5 Bus / 1.9 TDI	75 kW 1896 cc	06.2006-11.2009	132129	25
VW	TRANSP. T5 Bus / 1.9 TDI	77 kW 1896 cc	04.2003-11.2009	132129	25
VW	TRANSP. T5 Bus / 2.0	85 kW 1984 cc	11.2003-	132129	25
VW	TRANSP. T5 Bus / 2.0 BiTDI	132 kW 1968 cc	09.2009-	132129	25
VW	TRANSP. T5 Bus / 2.0 BiTDI 4mot.	132 kW 1968 cc	09.2009-	132129	25
VW	TRANSP. T5 Bus / 2.0 TDI	100 kW 1968 cc	05.2010-	132129	25
VW	TRANSP. T5 Bus / 2.0 TDI	103 kW 1968 cc	09.2009-	132129	25
VW	TRANSP. T5 Bus / 2.0 TDI	62 kW 1968 cc	09.2009-	132129	25
VW	TRANSP. T5 Bus / 2.0 TDI	75 kW 1968 cc	09.2009-	132129	25
VW	TRANSP. T5 Bus / 2.0 TDI 4mot.	100 kW 1968 cc	05.2010-	132129	25
VW	TRANSP. T5 Bus / 2.0 TDI 4mot.	103 kW 1968 cc	09.2009-	132129	25
VW	TRANSP. T5 Kasten / 1.9 TDI	62 kW 1896 cc	01.2006-11.2009	132129	25
VW	TRANSP. T5 Kasten / 1.9 TDI	63 kW 1896 cc	04.2003-11.2009	132129	25
VW	TRANSP. T5 Kasten / 1.9 TDI	75 kW 1896 cc	06.2006-11.2009	132129	25
VW	TRANSP. T5 Kasten / 1.9 TDI	77 kW 1896 cc	04.2003-11.2009	132129	25
VW	TRANSP. T5 Kasten / 2.0	85 kW 1984 cc	11.2003-	132129	25
VW	TRANSP. T5 Kasten / 2.0 BiTDI	132 kW 1968 cc	09.2009-	132129	25
VW	TRANSP. T5 Kasten / 2.0 TDI	103 kW 1968 cc	09.2009-	132129	25
VW	TRANSP. T5 Kasten / 2.0 TDI	62 kW 1968 cc	09.2009-	132129	25
VW	TRANSP. T5 Kasten / 2.0 TDI	75 kW 1968 cc	09.2009-	132129	25
VW	TRANSP. T5 Kasten / 2.0 TDI 4mot.	103 kW 1968 cc	09.2009-	132129	25
VW	TRANSP. V / 1.9 TDI	62 kW 1896 cc	01.2006-11.2009	132129	25
VW	TRANSP. V / 1.9 TDI	63 kW 1896 cc	04.2003-11.2009	132129	25
VW	TRANSP. V / 1.9 TDI	75 kW 1896 cc	06.2006-11.2009	132129	25
VW	TRANSP. V / 1.9 TDI	77 kW 1896 cc	04.2003-11.2009	132129	25
VW	TRANSP. V / 2.0	85 kW 1984 cc	11.2003-	132129	25
VW	TRANSP. V / 2.0 BiTDI	132 kW 1968 cc	09.2009-	132129	25
VW	TRANSP. V / 2.0 BiTDI 4mot.	132 kW 1968 cc	09.2009-	132129	25
VW	TRANSP. V / 2.0 TDI	103 kW 1968 cc	09.2009-	132129	25
VW	TRANSP. V / 2.0 TDI	62 kW 1968 cc	09.2009-	132129	25
VW	TRANSP. V / 2.0 TDI	75 kW 1968 cc	09.2009-	132129	25
VW	TRANSP. V / 2.0 TDI 4mot.	103 kW 1968 cc	09.2009-	132129	25
VW	TRANSP. V Bus / 1.9 TDI	62 kW 1896 cc	01.2006-11.2009	132129	25
VW	TRANSP. V Bus / 1.9 TDI	63 kW 1896 cc	04.2003-11.2009	132129	25
VW	TRANSP. V Bus / 1.9 TDI	75 kW 1896 cc	06.2006-11.2009	132129	25
VW	TRANSP. V Bus / 1.9 TDI	77 kW 1896 cc	04.2003-11.2009	132129	25
VW	TRANSP. V Bus / 2.0	85 kW 1984 cc	11.2003-	132129	25
VW	TRANSP. V Bus / 2.0 BiTDI	132 kW 1968 cc	09.2009-	132129	25
VW	TRANSP. V Bus / 2.0 BiTDI 4mot.	132 kW 1968 cc	09.2009-	132129	25
VW	TRANSP. V Bus / 2.0 TDI	100 kW 1968 cc	05.2010-	132129	25
VW	TRANSP. V Bus / 2.0 TDI	103 kW 1968 cc	09.2009-	132129	25
VW	TRANSP. V Bus / 2.0 TDI	62 kW 1968 cc	09.2009-	132129	25
VW	TRANSP. V Bus / 2.0 TDI	75 kW 1968 cc	09.2009-	132129	25
VW	TRANSP. V Bus / 2.0 TDI 4mot.	100 kW 1968 cc	05.2010-	132129	25
VW	TRANSP. V Bus / 2.0 TDI 4mot.	103 kW 1968 cc	09.2009-	132129	25
VW	TRANSP. V Kasten / 1.9 TDI	62 kW 1896 cc	01.2006-11.2009	132129	25
VW	TRANSP. V Kasten / 1.9 TDI	63 kW 1896 cc	04.2003-11.2009	132129	25
VW	TRANSP. V Kasten / 1.9 TDI	75 kW 1896 cc	06.2006-11.2009	132129	25
VW	TRANSP. V Kasten / 1.9 TDI	77 kW 1896 cc	04.2003-11.2009	132129	25
VW	TRANSP. V Kasten / 2.0	85 kW 1984 cc	11.2003-	132129	25
VW	TRANSP. V Kasten / 2.0 BiTDI	132 kW 1968 cc	09.2009-	132129	25
VW	TRANSP. V Kasten / 2.0 TDI	103 kW 1968 cc	09.2009-	132129	25
VW	TRANSP. V Kasten / 2.0 TDI	62 kW 1968 cc	09.2009-	132129	25
VW	TRANSP. V Kasten / 2.0 TDI	75 kW 1968 cc	09.2009-	132129	25
VW	TRANSP. V Kasten / 2.0 TDI 4mot.	103 kW 1968 cc	09.2009-	132129	25
VW	TRANSP. V Kasten 2.0 BiTDI 4mot.	132 kW 1968 cc	09.2009-	132129	25
VW	TRANSP.CARAV. Mk IV Bus 2.5TDI Sync	75 kW 2461 cc	01.1996-04.2003	132061	23
VW	TRANSP.CARAV. Mk IV Bus2.4 D Syncro	57 kW 2370 cc	10.1992-09.1998	132061	23
VW	TRANSP.CARAV. Mk IV Bus2.4 D Syncro	57 kW 2370 cc	10.1992-09.1998	132062	23
VW	TRANSP.CARAV. Mk IV Bus2.4 D Syncro	57 kW 2370 cc	10.1992-09.1998	132063	23
VW	TRANSP.CARAV. Mk V Bus2.0 BiTDI 4mot.	132 kW 1968 cc (CFCA)	09.2009-	132129	25
VW	TRANSP.CARAV. Mk V Bus2.0 TDI 4mot.	100 kW 1968 cc (CAAE)	05.2010-	132129	25
VW	TRANSP.CARAV. Mk V Bus2.0 TDI 4mot.	103 kW 1968 cc (CAAC)	09.2009-	132129	25
VW	TRANSP.CARAV. MkIII Bus1.6 TD Syncro	51 kW 1589 cc	03.1986-07.1992	132062	23
VW	TRANSP.CARAV. MkIII Bus1.6 TD Syncro	51 kW 1589 cc	03.1986-07.1992	132063	23
VW	TRANSP.CARAV. V Bus2.0 BiTDI 4mot.	132 kW 1968 cc	09.2009-	132129	25



Modell
Model

Motor
Engine



Baujahr
Construction year

HÜCO-NO. Seite
Page

	Modell Model	Motor Engine	Baujahr Construction year	HÜCO-NO.	Seite Page
VW	TRANSP.CARAVELLE III Bus1.6 TD Syncro	51 kW 1589 cc	03.1986-07.1992	132063	23
VW	TRANSP.CARAVELLE III Bus1.6 TD Syncro	51 kW 1968 cc	03.1986-07.1992	132062	23
VW	VENTO (1H2) / 1.9 TD	55 kW 1896 cc	11.1991-09.1998	132062	23
VW	VENTO III (1K2) / 1.6 TDI	66 kW 1598 cc	12.2009-10.2010	132106	24
VW	VENTO III (1K2) / 1.6 TDI	77 kW 1598 cc	06.2009-10.2010	132106	24
VW	VENTO III (1K2) / 1.6 TDI	77 kW 1598 cc	06.2009-10.2010	132129	25
VW	VENTO III (1K2) / 1.9 TDI	77 kW 1896 cc	08.2005-10.2010	132104	24
VW	VENTO III (1K2) / 1.9 TDI	77 kW 1896 cc	08.2005-10.2010	132106	24
VW	VENTO III (1K2) / 1.9 TDI	77 kW 1896 cc	08.2005-10.2010	132107	24
VW	VENTO III (1K2) / 1.9 TDI	77 kW 1896 cc	08.2005-10.2010	132128	25
VW	VENTO III (1K2) / 1.9 TDI	77 kW 1896 cc	08.2005-10.2010	132129	25
VW	VENTO III (1K2) / 2.0 TDI	100 kW 1968 cc	09.2005-10.2010	132104	24
VW	VENTO III (1K2) / 2.0 TDI	100 kW 1968 cc	09.2005-10.2010	132106	24
VW	VENTO III (1K2) / 2.0 TDI	100 kW 1968 cc	09.2005-10.2010	132128	25
VW	VENTO III (1K2) / 2.0 TDI	100 kW 1968 cc	09.2005-10.2010	132129	25
VW	VENTO III (1K2) / 2.0 TDI	103 kW 1968 cc	10.2005-10.2010	132106	24
VW	VENTO III (1K2) / 2.0 TDI	103 kW 1968 cc	10.2005-10.2010	132128	25
VW	VENTO III (1K2) / 2.0 TDI	125 kW 1968 cc	10.2006-10.2010	132106	24
VW	VENTO III (1K2) / 2.0 TDI 16V	103 kW 1968 cc	08.2005-10.2010	132104	24
VW	VENTO III (1K2) / 2.0 TDI 16V	103 kW 1968 cc	08.2005-10.2010	132106	24
VW	VENTO III (1K2) / 2.0 TDI 16V	103 kW 1968 cc	08.2005-10.2010	132107	24
VW	VENTO III (1K2) / 2.0 TDI 16V	103 kW 1968 cc	08.2005-10.2010	132108	24
VW	VENTO III (1K2) / 2.0 TDI 16V	103 kW 1968 cc	08.2005-10.2010	132127	25
VW	VENTO III (1K2) / 2.0 TDI 16V	103 kW 1968 cc	08.2005-10.2010	132128	25
VW	VENTO III (1K2) / 2.0 TDI 16V	103 kW 1968 cc	08.2005-10.2010	132129	25
VW	VENTO Stufenh. (1H2) / 1.9 TD	55 kW 1896 cc	11.1991-09.1998	132062	23

Allgemeine Verkaufs- und Lieferbedingungen

Garantiebedingungen 01/2011

I. Allgemeine Bestimmungen

1. Für den Umfang der Lieferungen oder Leistungen (im Folgenden: Lieferungen) sind die beiderseitigen schriftlichen Erklärungen maßgebend. Allgemeine Geschäftsbedingungen des Bestellers gelten jedoch nur insoweit, als der Lieferer oder Leistende (im Folgenden: Lieferer) ihnen ausdrücklich schriftlich zugestimmt hat.
2. An Kostenvorschlägen, Zeichnungen und anderen Unterlagen (im Folgenden: Unterlagen) behält sich Der Lieferer seine eigentums- und urheberrechtlichen Verwertungsrechte uneingeschränkt vor. Die Unterlagen dürfen nur nach vorheriger Zustimmung des Lieferers Dritten zugänglich gemacht werden und sind, wenn der Auftrag dem Lieferer nicht erteilt wird, diesem auf Verlangen unverzüglich zurückzugeben. Die Sätze 1 und 2 gelten entsprechend für Unterlagen des Bestellers; diese dürfen jedoch solchen Dritten zugänglich gemacht werden, denen der Lieferer zulässigerweise Lieferungen übertragen hat.
3. An Standardsoftware hat der Besteller das nicht ausschließliche Recht zur Nutzung mit den vereinbarten Leistungsmerkmalen in unveränderter Form auf den vereinbarten Geräten. Der Besteller darf ohne ausdrückliche Vereinbarung eine Sicherungskopie erstellen.
4. Teillieferungen sind zulässig, soweit sie dem Besteller zumutbar sind.
3. Kommt der Lieferer in Verzug, kann der Besteller - sofern er glaubhaft macht, dass ihm hieraus ein Schaden entstanden ist - eine Entschädigung für jede vollendete Woche des Verzuges von je 0,5 %, insgesamt jedoch höchstens 5% des Preises für den Teil der Lieferungen verlangen, der wegen des Verzuges nicht in zweckdienlichen Betrieb genommen werden konnte.
4. Sowohl Schadensersatzansprüche des Bestellers wegen Verzögerung der Lieferung als auch Schadensersatzansprüche statt der Leistung, die über die in Nr. 3 genannten Grenzen hinausgehen, sind in allen Fällen verzögerter Lieferung, auch nach Ablauf einer dem Lieferer etwa gesetzten Frist zur Lieferung, ausgeschlossen. Dies gilt nicht, soweit in Fällen des Vorsatzes, der groben Fahrlässigkeit oder wegen der Verletzung des Lebens, des Körpers oder der Gesundheit zwingend gehaftet wird. Vom Vertrag kann der Besteller im Rahmen der gesetzlichen Bestimmungen nur zurücktreten, soweit die Verzögerung der Lieferung vom Lieferer zu vertreten ist. Eine Änderung der Beweislast zum Nachteil des Bestellers ist mit den vorstehenden Regelungen nicht verbunden.
5. Der Besteller ist verpflichtet, auf Verlangen des Lieferers innerhalb einer angemessenen Frist zu erklären, ob er wegen der Verzögerung der Lieferung vom Vertrag zurücktritt oder auf die Lieferung besteht.
6. Werden Versand oder Zustellung auf Wunsch des Bestellers um mehr als einen Monat nach Anzeige der Versandbereitschaft verzögert, kann dem Besteller für jeden angefangenen Monat Lagergeld in Höhe von 0,5% des Preises der Gegenstände der Lieferungen, höchstens jedoch insgesamt 5% berechnet werden. Der Nachweis höherer oder niedrigerer Lagerkosten bleibt den Vertragsparteien unbenommen.

II. Preise und Zahlungsbedingungen

1. Die Preise verstehen sich ab Werk ausschließlich Verpackung zuzüglich der jeweils geltenden gesetzlichen Umsatzsteuer.
2. Hat der Lieferer die Aufstellung oder Montage übernommen und ist nicht etwas anderes vereinbart, so trägt der Besteller neben der vereinbarten Vergütung alle erforderlichen Nebenkosten wie Reisekosten, Kosten für den Transport des Handwerkszeugs und des persönlichen Gepäcks sowie Auslösungen.
3. Zahlungen sind frei Zahlstelle des Lieferers zu leisten.
4. Der Besteller kann nur mit solchen Forderungen aufrechnen, die unbestritten oder rechtskräftig festgestellt sind.

III. Eigentumsvorbehalt

1. Die Gegenstände der Lieferungen (Vorbehaltsware) bleiben Eigentum des Lieferers bis zur Erfüllung sämtlicher ihm gegen den Besteller aus der Geschäftsverbindung zustehenden Ansprüche. Soweit der Wert aller Sicherungsrechte, die dem Lieferer zustehen, die Höhe aller gesicherten Ansprüche um mehr als 20 % übersteigt, wird der Lieferer auf Wunsch des Bestellers einen entsprechenden Teil der Sicherungsrechte freigeben.
2. Während des Bestehens des Eigentumsvorbehalts ist dem Besteller eine Verpfändung oder Sicherungsübereignung untersagt und die Weiterveräußerung nur Wiederverkäufern im gewöhnlichen Geschäftsgang und nur unter der Bedingung gestattet, dass der Wiederverkäufer von seinem Kunden Bezahlung erhält oder den Vorbehalt macht, dass das Eigentum auf den Kunden erst übergeht, wenn dieser seine Zahlungsverpflichtungen erfüllt hat.
3. Bei Pfändungen, Beschlagnahmen oder sonstigen Verfügungen oder Eingriffen Dritter hat der Besteller den Lieferer unverzüglich zu benachrichtigen.
4. Bei Pflichtverletzungen des Bestellers, insbesondere bei Zahlungsverzug, ist der Lieferer nach erfolglosem Ablauf einer dem Besteller gesetzten angemessenen Frist zur Leistung zum Rücktritt und zur Rücknahme berechtigt; die gesetzlichen Bestimmungen über die Entbehrlichkeit einer Fristsetzung bleiben unberührt. Der Besteller ist zur Herausgabe verpflichtet.

IV. Fristen für Lieferungen; Verzug

1. Die Einhaltung von Fristen für Lieferungen setzt den rechtzeitigen Eingang sämtlicher vom Besteller zu liefernden Unterlagen, erforderlichen Genehmigungen und Freigaben, insbesondere von Plänen, sowie die Einhaltung der vereinbarten Zahlungsbedingungen und sonstigen Verpflichtungen durch den Besteller voraus. Werden diese Voraussetzungen nicht rechtzeitig erfüllt, so verlängern sich die Fristen angemessen; dies gilt nicht, wenn der Lieferer die Verzögerung zu vertreten hat.
2. Ist die Nichteinhaltung der Fristen auf höhere Gewalt, z. B. Mobilmachung, Krieg, Aufruhr, oder auf ähnliche Ereignisse, z. B. Streik, Aussperrung, zurückzuführen, verlängern sich die Fristen angemessen.

V. Gefahrübergang

1. Die Gefahr geht auch bei frachtfreier Lieferung wie folgt auf den Besteller über:
 - a) bei Lieferungen ohne Aufstellung oder Montage, wenn sie zum Versand gebracht oder abgeholt worden sind. Auf Wunsch und Kosten des Bestellers werden Lieferungen vom Lieferer gegen die üblichen Transportrisiken versichert;
 - b) bei Lieferungen mit Aufstellung oder Montage am Tage der Übernahme in eigenen Betrieb oder, soweit vereinbart, nach einwandfreiem Probebetrieb.
2. Wenn der Versand, die Zustellung, der Beginn, die Durchführung der Aufstellung oder Montage, die Übernahme in eigenen Betrieb oder der Probebetrieb aus vom Besteller zu vertretenden Gründen verzögert wird, oder der Besteller aus sonstigen Gründen in Annahmeverzug kommt, so geht die Gefahr auf den Besteller über.

VI. Aufstellung und Montage

Für die Aufstellung und Montage gelten, soweit nichts anderes schriftlich vereinbart ist, folgende Bestimmungen:

1. Der Besteller hat auf seine Kosten zu übernehmen und rechtzeitig zu stellen:
 - a) alle Erd-, Bau- und sonstigen branchenfremden Nebearbeiten einschließlich der dazu benötigten Fach- und Hilfskräfte, Baustoffe und Werkzeuge,
 - b) die zur Montage und Inbetriebsetzung erforderlichen Bedarfsgegenstände und -stoffe, wie Gerüste, Hebezeuge und andere Vorrichtungen, Brennstoffe und Schmiermittel,
 - c) Energie und Wasser an der Verwendungsstelle einschließlich der Anschlüsse, Heizung und Beleuchtung,
 - d) bei der Montagestelle für die Aufbewahrung der Maschinenteile, Apparaturen, Materialien, Werkzeuge usw. genügend große, geeignete, trockene und verschleißbare Räume und für das Montagepersonal angemessene Arbeits- und Aufenthaltsräume einschließlich den Umständen angemessener sanitärer Anlagen; im Übrigen hat der Besteller zum Schutz des Besitzes des Lieferers und des Montagepersonals auf der Baustelle die Maßnahmen zu treffen, die er zum Schutz des eigenen Besitzes ergreifen würde,
 - e) Schutzkleidung und Schutzvorrichtungen, die infolge besonderer Umstände der Montagestelle erforderlich sind.
2. Vor Beginn der Montagearbeiten hat der Besteller die nötigen Angaben über die Lage verdeckt geführter Strom-, Gas-, Wasserleitungen oder ähnlicher Anlagen sowie die erforderlichen

statischen Angaben unaufgefordert zur Verfügung zu stellen.

3. Vor Beginn der Aufstellung oder Montage müssen sich die für die Aufnahme der Arbeiten erforderlichen Bestellungen und Gegenstände an der Aufstellungs- oder Montagestelle befinden und alle Vorarbeiten vor Beginn des Aufbaues so weit fortgeschritten sein, dass die Aufstellung oder Montage vereinbarungsgemäß begonnen und ohne Unterbrechung durchgeführt werden kann. Anfuhrwege und der Aufstellungs- oder Montageplatz müssen geebnet und geräumt sein.
4. Verzögern sich die Aufstellung, Montage oder Inbetriebnahme durch nicht vom Lieferer zu vertretende Umstände, so hat der Besteller in angemessenem Umfang die Kosten für Wartezeit und zusätzlich erforderliche Reisen des Lieferers oder des Montagepersonals zu tragen.
5. Der Besteller hat dem Lieferer wöchentlich die Dauer der Arbeitszeit des Montagepersonals sowie die Beendigung der Aufstellung, Montage oder Inbetriebnahme unverzüglich zu bescheinigen.
6. Verlangt der Lieferer nach Fertigstellung die Abnahme der Lieferung, so hat sie der Besteller innerhalb von zwei Wochen vorzunehmen. Geschieht dies nicht, so gilt die Abnahme als erfolgt. Die Abnahme gilt gleichfalls als erfolgt, wenn die Lieferung - gegebenenfalls nach Abschluss einer vereinbarten Testphase - in Gebrauch genommen worden ist.

VII. Entgegennahme

Der Besteller darf die Entgegennahme von Lieferungen wegen unerheblicher Mängel nicht verweigern.

VIII. Sachmängel

Für Sachmängel haftet der Lieferer wie folgt:

1. Alle diejenigen Teile oder Leistungen sind nach Wahl des Lieferers unentgeltlich nachzubessern, neu zu liefern oder neu zu erbringen, die innerhalb der Verjährungsfrist - ohne Rücksicht auf die Betriebsdauer - einen Sachmangel aufweisen, sofern dessen Ursache bereits im Zeitpunkt des Gefahrübergangs vorlag.
2. Sachmängelansprüche verjähren in 24 Monaten. Die Dauer von 24 Monaten gilt nicht, soweit das Gesetz gemäß §§ 438 Abs. 1 Nr. 2 (Bauwerke und Sachen für Bauwerke), 479 Abs. 1 (Rückgriffsanspruch) und 634a Abs. 1 Nr. 2 (Baumängel) BGB längere Fristen vorschreibt. Die gesetzlichen Regelungen über Ablaufhemmung, Hemmung und Neubeginn der Fristen bleiben unberührt.
3. Der Besteller hat Sachmängel gegenüber dem Lieferer unverzüglich schriftlich zu rügen.
4. Bei Mängelrügen dürfen Zahlungen des Bestellers in einem Umfang zurückgehalten werden, die in einem angemessenen Verhältnis zu den aufgetretenen Sachmängeln stehen. Der Besteller kann Zahlungen nur zurückhalten, wenn eine Mängelrüge geltend gemacht wird, über deren Berechtigung kein Zweifel bestehen kann. Erfolgte die Mängelrüge zu Unrecht, ist der Lieferer berechtigt, die ihm entstandenen Aufwendungen vom Besteller ersetzt zu verlangen.
5. Zunächst ist dem Lieferer Gelegenheit zur Nacherfüllung innerhalb angemessener Frist zu gewähren.
6. Schlägt die Nacherfüllung fehl, kann der Besteller - unbeschadet etwaiger Schadensersatzansprüche gemäß Art. XI - vom Vertrag zurücktreten oder die Vergütung mindern.
7. Mängelansprüche bestehen nicht bei nur unerheblicher Abweichung von der vereinbarten Beschaffenheit, bei natürlicher Abnutzung oder Schäden, die nach dem Gefahrübergang infolge fehlerhafter oder nachlässiger Behandlung, übermäßiger Beanspruchung, ungeeigneter Betriebsmittel, oder die aufgrund besonderer äußerer Einflüsse entstehen, die nach dem Vertrag nicht vorausgesetzt sind, sowie bei nicht reproduzierbaren Softwarefehlern. Werden vom Besteller oder von Dritten un-sachgemäß Änderungen oder Instandsetzungsarbeiten vorgenommen, so bestehen für diese und die daraus entstehenden Folgen ebenfalls keine Mängelansprüche.
8. Ansprüche des Bestellers wegen der zum Zweck der Nacherfüllung erforderlichen Aufwendungen, insbesondere Transport-, Wege-, Arbeits- und Materialkosten, sind ausgeschlossen, soweit die Aufwendungen sich erhöhen, weil der Gegenstand der Lieferung nachträglich an einen anderen Ort als die Niederlassung

Allgemeine Verkaufs- und Lieferbedingungen

Garantiebedingungen 01/2011

des Bestellers verbracht worden ist, es sei denn, die Verbringung entspricht seinem bestimmungsgemäßen Gebrauch.

- Rückgriffsansprüche des Bestellers gegen den Lieferer gemäß § 478 BGB (Rückgriff des Unternehmers) bestehen nur insoweit, als der Besteller mit seinem Abnehmer keine über die gesetzlichen Mängelansprüche hinausgehenden Vereinbarungen getroffen hat. Für den Umfang des Rückgriffsanspruchs des Bestellers gegen den Lieferer gemäß § 478 Abs. 2 BGB gilt ferner Nr. 8 entsprechend.
- Für Schadensersatzansprüche gilt im Übrigen Art. XI (Sonstige Schadensersatzansprüche). Weitergehende oder andere als die in diesem Art. VIII geregelten Ansprüche des Bestellers gegen den Lieferer und dessen Erfüllungsgehilfen wegen eines Sachmangels sind ausgeschlossen.

VIII. Garantie

Wir verweisen auf unsere separaten Garantiebedingungen, die auf Wunsch gern ausgehändigt werden.

IX. Gewerbliche Schutzrechte und Urheberrechte; Rechtsmängel

- Sofern nicht anders vereinbart, ist der Lieferer verpflichtet, die Lieferung lediglich im Land des Lieferorts frei von gewerblichen Schutzrechten und Urheberrechten Dritter (im Folgenden: Schutzrechte) zu erbringen. Sofern ein Dritter wegen der Verletzung von Schutzrechten durch vom Lieferer erbrachte, vertragsgemäß genutzte Lieferungen gegen den Besteller berechnete Ansprüche erhebt, haftet der Lieferer gegen über dem Besteller innerhalb der in Art. VIII Nr. 2 bestimmten Frist wie folgt:
 - Der Lieferer wird nach seiner Wahl und auf seine Kosten für die betreffenden Lieferungen entweder ein Nutzungsrecht erwirken, sie so ändern, dass das Schutzrecht nicht verletzt wird, oder austauschen. Ist dies dem Lieferer nicht zu angemessenen Bedingungen möglich, stehen dem Besteller die gesetzlichen Rücktritts- oder Minderungsrechte zu.
 - Die Pflicht des Lieferers zur Leistung von Schadensersatz richtet sich nach Art. XI.
 - Die vorstehend genannten Verpflichtungen des Lieferers bestehen nur, soweit der Besteller den Lieferer über die vom Dritten geltend gemachten Ansprüche unverzüglich schriftlich verständigt, eine Verletzung nicht anerkennt und dem Lieferer alle Abwehrmaßnahmen und Vergleichsverhandlungen vorbehalten bleiben. Stellt der Besteller die Nutzung der Lieferung aus Schadensminderungs- oder sonstigen wichtigen Gründen ein, ist er verpflichtet, den Dritten darauf hinzuweisen, dass mit der Nutzungseinstellung kein Anerkenntnis einer Schutzrechtsverletzung verbunden ist.
- Ansprüche des Bestellers sind ausgeschlossen, soweit er die Schutzrechtsverletzung zu vertreten hat.
- Ansprüche des Bestellers sind ferner ausgeschlossen, soweit die Schutzrechtsverletzung durch spezielle Vorgaben des Bestellers, durch eine vom Lieferer nicht voraussehbare Anwendung oder dadurch verursacht wird, dass die Lieferung vom Besteller verändert oder zusammen mit nicht vom Lieferer gelieferten Produkten eingesetzt wird.
- Im Falle von Schutzrechtsverletzungen gelten für die in Nr. 1 a) geregelten Ansprüche des Bestellers im Übrigen die Bestimmungen des Art. VIII Nr. 4, 5 und 9 entsprechend.
- Bei Vorliegen sonstiger Rechtsmängel gelten die Bestimmungen des Art. VIII entsprechend.
- Weitergehende oder andere als die in diesem Art. IX geregelten Ansprüche des Bestellers gegen den Lieferer und dessen Erfüllungsgehilfen wegen eines Rechtsmangels sind ausgeschlossen.

X. Unmöglichkeit; Vertragsanpassung

- Soweit die Lieferung unmöglich ist, ist der Besteller berechtigt, Schadensersatz zu verlangen, es sei denn, dass der Lieferer die Unmöglichkeit nicht zu vertreten hat. Jedoch beschränkt sich der Schadensersatzanspruch des Bestellers auf 10 % des Wertes desjenigen Teils der Lieferung, der wegen der Unmöglichkeit nicht in zweckdienlichen Betrieb genommen werden kann. Diese Beschränkung gilt nicht, soweit in Fällen des Vorsatzes, der groben Fahrlässigkeit oder wegen der Verletzung des Lebens, des Körpers oder der Gesundheit zwingend gehaftet wird; eine Änderung der Beweislast zum Nachteil des Bestellers ist hiermit

nicht verbunden. Das Recht des Bestellers zum Rücktritt vom Vertrag bleibt unberührt.

- Sofern unvorhersehbare Ereignisse im Sinne von Art. IV Nr. 2 die wirtschaftliche Bedeutung oder den Inhalt der Lieferung erheblich verändern oder auf den Betrieb des Lieferers erheblich einwirken, wird der Vertrag unter Beachtung von Treu und Glauben angemessen angepasst. Soweit dies wirtschaftlich nicht vertretbar ist, steht dem Lieferer das Recht zu, vom Vertrag zurückzutreten. Will er von diesem Rücktrittsrecht Gebrauch machen, so hat er dies nach Erkenntnis der Tragweite des Ereignisses unverzüglich dem Besteller mitzuteilen und zwar auch dann, wenn zunächst mit dem Besteller eine Verlängerung der Lieferzeit vereinbart war.

XI. Sonstige Schadensersatzansprüche

- Schadens- und Aufwendungsersatzansprüche des Bestellers (im Folgenden: Schadensersatzansprüche), gleich aus welchem Rechtsgrund, insbesondere wegen Verletzung von Pflichten aus dem Schuldverhältnis und aus unerlaubter Handlung, sind ausgeschlossen, soweit nicht Vorsatz oder grobe Fahrlässigkeit vorliegt oder wegen der Verletzung des Lebens, des Körpers oder der Gesundheit gehaftet wird.
- Dies gilt nicht, soweit zwingend gehaftet wird, z. B. nach dem Produkthaftungsgesetz, in Fällen des Vorsatzes, der groben Fahrlässigkeit, wegen der Verletzung des Lebens, des Körpers oder der Gesundheit, wegen der Verletzung wesentlicher Vertragspflichten. Der Schadensersatzanspruch für die Verletzung wesentlicher Vertragspflichten ist jedoch auf den vertragstypischen, vorhersehbaren Schaden begrenzt, soweit nicht Vorsatz oder grobe Fahrlässigkeit vorliegt oder wegen der Verletzung des Lebens, des Körpers oder der Gesundheit gehaftet wird. Eine Änderung der Beweislast zum Nachteil des Bestellers ist mit den vorstehenden Regelungen nicht verbunden.
- Soweit dem Besteller nach diesem Art. XI Schadensersatzansprüche zustehen, verjähren diese mit Ablauf der für Sachmängelansprüche geltenden Verjährungsfrist gemäß Art. VIII Nr. 2. Bei Schadensersatzansprüchen nach dem Produkthaftungsgesetz gelten die gesetzlichen Verjährungsvorschriften.

XII. Gerichtsstand und anwendbares Recht

- Alleiniger Gerichtsstand ist, wenn der Besteller Kaufmann ist, bei allen aus dem Vertragsverhältnis unmittelbar oder mittelbar sich ergebenden Streitigkeiten der Sitz des Lieferers. Der Lieferer ist jedoch auch berechtigt, am Sitz des Bestellers zu klagen.
- Für die Rechtsbeziehungen im Zusammenhang mit diesem Vertrag gilt deutsches materielles Recht unter Ausschluss des Übereinkommens der Vereinten Nationen über Verträge über den internationalen Warenkauf (CISG).

XIII. Verbindlichkeit des Vertrages

Der Vertrag bleibt auch bei rechtlicher Unwirksamkeit einzelner Bestimmungen in seinen übrigen Teilen verbindlich. Das gilt nicht, wenn das Festhalten an dem Vertrag eine unzumutbare Härte für eine Partei darstellen würde.

XIV. Katalogangaben

Es gelten nur die jeweils im Zeitpunkt des Vertragsabschlusses gültigen Kataloge des Lieferers. Alle vorangegangenen Kataloge und die dort gemachten Angaben verlieren durch den bei Vertragsabschluss geltenden Katalog ihre Gültigkeit. Alle im Katalog genannten technischen Werte der Produkte des Lieferers geben durchschnittlich ermittelte Ergebnisse elektronischer Betriebsdaten wieder.

Garantiebedingungen 01/2011

- Unbeschadet der in gesetzlichen Regelungen begründeten Sachmängelhaftung übernimmt der Lieferer für die von ihm gelieferten Produkte eine Haltbarkeitsgarantie gemäß den nachfolgenden Bedingungen:
- Der Lieferer garantiert die Mängelfreiheit der unter dem Markennamen und in Verpackung „HÜCO“ gelieferten Waren über einen Zeitraum von 60 Monaten, die Mängelfreiheit aller anderen Waren über einen Zeitraum von 36 Monaten, jeweils gerechnet ab Lieferung der Sache. Ausgenommen sind Verschleißteile, die Teile der vom Lieferer gelieferten Produkte sein können.

- Die Garantie erstreckt sich nur auf Sachmängel, die auf Material- oder Herstellungsfehler zurückzuführen sind, nicht hingegen auf Verschlechterungen der gelieferten Sache durch üblichen Verschleiß. Ausgenommen sind ferner unerhebliche Abweichungen von der vereinbarten Beschaffenheit, unerhebliche Beeinträchtigungen der Brauchbarkeit, natürliche Abnutzung und Schäden, die nach der Gebrauchsüberlassung in Folge fehlerhafter oder nachlässiger Behandlung, übermäßiger Beanspruchung, ungeeigneter Betriebsmittel oder auf Grund besonderer äußerer Einflüsse entstehen. Ebenfalls ausgenommen sind nicht vom Lieferer verbaute und/oder nicht vom Lieferer freigegebene Bauteile sowie Schäden in Folge der Verwendung derartiger Bauteile sowie generell Schäden in Folge von Reparaturen oder Reparaturversuchen, die nicht vom Lieferer oder von diesem autorisierten Personen unternommen wurden, sowie Schäden durch sonstige eigenmächtige Eingriffe in das Bauteil. Ausgenommen sind ferner Schäden durch chemische oder elektrochemische Einwirkung, unsachgemäße Verwendung, fehlerhaften Einbau oder Anschluss, extreme Witterungseinflüsse, Nichtbeachtung der Montage- und Wartungseinleitung sowie nicht vom Lieferer zu vertretende Sportschäden.
- Auf Grund der Garantie liefert der Lieferer in von der Garantie erfassten Fällen nach seiner Wahl Ersatz für die mangelhafte Sache oder beseitigt den Mangel. Voraussetzung ist eine unverzüglich schriftliche Mängelrüge des Bestellers, die den Mangel möglichst klar beschreibt. Erfolgte die Mängelrüge zu Unrecht, ist der Lieferer berechtigt, Ersatz der ihm durch die und in Folge der unberechtigten Mängelrüge entstandenen Aufwendungen zu verlangen.
- Diese Garantie deckt weder die Kosten für den Transport des Produkts im Garantiefall zum Hersteller noch mit dem Transport zusammenhängenden Risiken.
- Weitergehende oder andere Ansprüche, insbesondere solche auf Ersatz außerhalb des Liefergegenstandes entstandener Schäden, sind im Rahmen dieser Garantie ausgeschlossen, können aber ggf. aufgrund gesetzlicher Haftungstatbestände bestehen.

HÜCO Automotive GmbH

I. General

1. The scope of deliveries and/or services (hereinafter referred to as „Supplies“) shall be determined by the written declarations of both Parties. General terms and conditions of the Purchaser shall apply only if and when expressly accepted by the supplier or the provider of services (hereinafter referred to as „Supplier“) in writing.
2. The Supplier herewith reserves any industrial property rights and/or copyrights pertaining to its cost estimates, drawings and other documents (hereinafter referred to as „Documents“). The Documents shall not be made accessible to third parties without the Supplier's prior consent and shall, upon request, be returned without Undue delay to the Supplier if the contract is not awarded to the Supplier. Sentences 1 and 2 shall apply mutatis mutandis to documents of the Purchaser; these may, however, be made accessible to third parties to whom the Supplier may rightfully transfer Supplies.
3. The Purchaser shall have the non-exclusive right to use standard software, provided that it remains unchanged, is used within the agreed performance parameters, and on the agreed equipment. The Purchaser may make one back-up copy without express agreement.
4. Partial Supplies shall be allowed, unless they are unreasonable to accept for the Purchaser.

II. Prices and terms of payment

1. Prices shall be ex works and exclude packaging; value added tax shall be added at the then applicable rate.
2. If the Supplier is also responsible for assembly or erection and unless otherwise agreed, the Purchaser shall pay the agreed remuneration and any incidental costs required, e. g. travel costs, costs for the transport of tools and equipment, and personal luggage as well as allowances.
3. Payments shall be made free Supplier's paying office.
4. The Purchaser may set off only those claims that are undisputed or against which no legal recourse is possible.

III. Retention of title

1. Items pertaining to the Supplies („Retained Goods“) shall remain the property of the Supplier until each and every claim the Supplier has against the Purchaser on account of the business connection has been fulfilled. If the combined value of the security interests of the Supplier exceeds the value of all secured claims by more than 20 %, the Supplier shall release a corresponding part of the security interest if so requested by the Purchaser.
2. For the duration of the retention of title, the Purchaser may not pledge the Retained Goods or use them as security, and resale shall be possible only for resellers in the ordinary course of their business and only on condition that the reseller receives payment from its customer or makes the transfer of property to the customer dependent upon the customer fulfilling its obligation to effect payment.
3. The Purchaser shall inform the Supplier forthwith of any seizure or other act of intervention by third parties.
4. Where the Purchaser fails to fulfil its duties, including failure to make payments due, the Supplier shall be entitled to cancel the contract and take back the Retained Goods in the case of continued failure following expiry of a reasonable time set by the Supplier; the statutory provisions that a time limit is not needed remain unaffected. The Purchaser shall be obliged to surrender the Retained Goods.

IV. Time for supplies; delay

1. Times set for Supplies can only be observed if all Documents to be supplied by the Purchaser, necessary permits and releases, especially concerning plans, are received in time and if agreed terms of payment and other obligations of the Purchaser are fulfilled. Unless these conditions are fulfilled in time, times set shall be extended appropriately; this shall not apply where the Supplier is responsible for the delay.
2. If non-observance of the times set is due to force majeure such as mobilization, war, rebellion or similar events, e. g. strike or lockout, such time shall be extended accordingly.
3. If the Supplier is responsible for the delay (hereinafter referred to as „Delay“) and the Purchaser demonstrably suffered a loss there from, the Purchaser may claim a compensation as liquidated damages of 0.5 % for every completed week of Delay, but in no case more than a total of 5 % of the price of that part

of the Supplies which because of the Delay could not be put to the intended use.

4. Purchaser's claims for damages due to delayed Supplies as well as claims for damages in lieu of performance exceeding the limits specified in No. 3 above shall be excluded in all cases of delayed Supplies even upon expiry of a time set to the Supplier to effect the Supplies. This shall not apply in cases of mandatory liability based on intent, gross negligence, or due to injury of life, body or health. Cancellation of the contract by the Purchaser based on statute shall be limited to cases where the Supplier is responsible for the delay. The above provisions do not imply a change in the burden of proof to the detriment of the Purchaser.
5. At the Supplier's request the Purchaser shall declare within a reasonable period of time whether the Purchaser cancels the contract due to the delayed Supplies or insists on the Supplies to be carried out.
6. If dispatch or shipment is delayed at the Purchaser's request by more than one month after notice of the readiness for dispatch was given, the Purchaser may be charged, for every month commenced, storage costs of 0.5 % of the price of the items of the Supplies, but in no case more than a total of 5 %. The parties to the contract may prove that higher or, as the case may be, lower storage costs have been incurred.

V. Transfer of risk

1. Even where delivery has been agreed freight free, the risk shall pass to the Purchaser as follows:
 - a) if the Supplies do not include assembly or erection, at the time when the Supplies are shipped or picked up by the carrier. Upon request of the Purchaser, the Supplier shall insure the Supplies against the usual risks of transport at the expense of the Purchaser;
 - b) if the Supplies include assembly or erection, at the day of taking over in the own works or, if so agreed, after a fault-free trial run.
2. The risk shall pass to the Purchaser if dispatch, shipping, the start or performance of assembly or erection, the taking over in the own works or the trial run is delayed for reasons for which the Purchaser is responsible or if the Purchaser has otherwise failed to accept the Supplies.

VI. Assembly and erection

Unless otherwise agreed in writing, assembly/erection shall be subject to the following provisions:

1. The Purchaser shall provide at its own expense and in good time:
 - a) all earth and construction work and other ancillary work outside the scope of the Supplier, including the necessary skilled and unskilled labour, construction materials and tools,
 - b) the equipment and materials necessary for assembly and commissioning such as scaffolds, lifting equipment and other devices as well as fuels and lubricants,
 - c) energy and water at the point of use including connections, heating and lighting,
 - d) suitable dry and lockable rooms of sufficient size adjacent to the site for the storage of machine parts, apparatus, materials, tools, etc. and adequate working and recreation rooms for the erection personnel, including sanitary facilities as are appropriate in the specific circumstances. Furthermore, the Purchaser shall take all measures it would take for the protection of its own possessions to protect the possessions of the Supplier and of the erection personnel at the site, e) protective clothing and protective devices needed due to particular conditions prevailing on the specific site.
2. Before the erection work starts, the Purchaser shall make available of its own accord any information required concerning the location of concealed electric power, gas and water lines or of similar installations as well as the necessary structural data.
3. Prior to assembly or erection, the materials and equipment necessary for the work to start must be available on the site of assembly/erection and any preparatory work must have advanced to such a degree that assembly/erection can be started as agreed and carried out without interruption. Access roads and the assembly/erection site itself must be level and clear.
4. If assembly, erection or commissioning is delayed due to circumstances for which the Supplier is not responsible, the Purchaser shall bear the reasonable costs incurred for idle times and any

- additional travelling of the Supplier or the erection personnel.
5. The Purchaser shall attest to the hours worked by the erection personnel towards the Supplier at weekly intervals and the Purchaser shall immediately confirm in writing if assembly, erection or commissioning has been completed.
6. If, after completion, the Supplier demands acceptance of the Supplies, the Purchaser shall comply therewith within a period of two weeks. In default thereof, acceptance is deemed to have taken place. Acceptance is also deemed to have been effected if the Supplies are put to use, after completion of an agreed test phase, if any.

VII. Receiving of supplies

The Purchaser shall not refuse to receive Supplies due to minor defects.

VIII. Defects as to quality

The Supplier shall be liable for defects as to quality („Sachmängel“, hereinafter referred to as „Defects“,) as follows:

1. All parts or services where a Defect becomes apparent within the limitation period shall, at the discretion of the Supplier, be repaired, replaced or provided again free of charge irrespective of the hours of operation elapsed, provided that the reason for the Defect had already existed at the time when the risk passed.
2. Claims based on Defects are subject to a limitation period of months. These provisions shall not apply where longer periods are prescribed by law according to Sec. 438 para. 1 No. 2 (buildings and things used for a building), Sec. 479 para. 1 (right of recourse), and Sec. 634a para. 1 No. 2 (defects of a building) German Civil Code („BGB“), as well as in cases of injury of life, body or health, or where the Supplier intentionally or grossly negligently fails to fulfil its obligation or fraudulently conceals a Defect. The legal provisions regarding suspension of expiration („Ablaufhemmung“), suspension („Hemmung“) and commencement of limitation periods remain unaffected.
3. The Purchaser shall notify Defects to the Supplier in writing and without undue delay.
4. In the case of notification of a Defect, the Purchaser may withhold payments to a reasonable extent taking into account the Defect occurred. The Purchaser, however, may withhold payments only if the subject-matter of the notification of the Defect occurred is justified beyond doubt. Unjustified notifications of Defect shall entitle the Supplier to have its expenses reimbursed by the Purchaser.
5. The Supplier shall first be given the opportunity to supplement its performance („Nacherfüllung“) within a reasonable period of time.
6. If supplementary performance is unsuccessful, the Purchaser shall be entitled to cancel the contract or reduce the remuneration, irrespective of any claims for damages it may have according to Art. XI.
7. There shall be no claims based on Defect in cases of insignificant deviations from the agreed quality, of only minor impairment of usefulness, of natural wear and tear or damage arising after the transfer of risk from faulty or negligent handling, excessive strain, unsuitable equipment, defective workmanship or from particular external influences not assumed under the contract, or from non-reproducible software errors. Claims based on defects attributable to improper modifications or repair work carried out by the Purchaser or third parties and the consequences thereof shall be likewise excluded.
8. The Purchaser shall have no claim with respect to expenses incurred in the course of supplementary performance, including costs of travel and transport, labour, and material, to the extent that expenses are increased because the subject-matter of the Supplies was subsequently brought to another location than the Purchaser's branch office, unless doing so complies with the intended use of the Supplies.
9. The Purchaser's right of recourse against the Supplier pursuant to Sec. 478 BGB is limited to cases where the Purchaser has not concluded an agreement with its customers exceeding the scope of the statutory provisions governing claims based on Defects. Moreover, No. 8 above shall apply mutatis mutandis to the scope of the right of recourse the Purchaser has against the Supplier pursuant to Sec. 478 para. 2 BGB.
10. Furthermore, the provisions of Art. XI (Other Claims for Damages) shall apply in respect of claims of damages. Any other claims

Sales and Supply Conditions

Guarantee Terms 01/2011

of the Purchaser against the Supplier or its agents or any such claims exceeding the claims provided for in this Art. VIII, based on a Defect, shall be excluded.

VIII a) Guarantee

Our guarantee terms apply. They are available upon request.

IX. Industrial property rights and copyright; defects in title

1. Unless otherwise agreed, the Supplier shall provide the Supplies free from third parties' industrial property rights and copyrights (hereinafter referred to as „IPR“) with respect to the country of the place of destination. If a third party asserts a justified claim against the Purchaser based on an infringement of an IPR with respect to the Supplies made by the Supplier and then used in conformity with the contract, the Supplier shall be liable to the Purchaser within the time period stipulated in Art. VIII No. 2 as follows:
 - a) The Supplier shall choose whether to acquire, at its own expense, the right to use the IPR with respect to the Supplies concerned or whether to modify the Supplies such that they no longer infringe the IPR or replace them. If this would be unreasonable to demand from the Supplier, the Purchaser may cancel the contract or reduce the remuneration pursuant to the applicable statutory provisions.
 - b) The Supplier's liability to pay damages shall be governed by Art. XI.
 - c) The above obligations of the Supplier shall only apply if the Purchaser (i) immediately notifies the Supplier of any such claim asserted by the third party in writing, (ii) does not concede the existence of an infringement and (iii) leaves any protective measures and settlement negotiations to the discretion of the Supplier. If the Purchaser stops using the Supplies in order to reduce the damage or for other good reason, it shall be obliged to point out to the third party that no acknowledgement of the alleged infringement may be inferred from the fact that the use has been discontinued.
2. Claims of the Purchaser shall be excluded if it is itself responsible for the infringement of an IPR.
3. Claims of the Purchaser shall also be excluded if the infringement of the IPR is caused by specifications made by the Purchaser, to a type of use not foreseeable by the Supplier or to the Supplies being modified by the Purchaser or being used together with products not provided by the Supplier.
4. In addition, with respect to claims by the Purchaser pursuant to No. 1 a) above, Art VIII Nos. 4, 5, and 9 shall apply mutatis mutandis in the event of an infringement of an IPR.
5. Where other defects in title occur, Art. VIII shall apply mutatis mutandis.
6. Any other claims of the Purchaser against the Supplier or its agents or any such claims exceeding the claims provided for in this Art. IX, based on a defect in title, shall be excluded.

X. Impossibility of performance; adaption of contract

1. To the extent that Supplies are impossible to be carried out, the Purchaser shall be entitled to claim damages, unless the Supplier is not responsible for the impossibility. The Purchaser's claim for damages shall, however, be limited to an amount of 10 % of the value of the part of the Supplies which, owing to the impossibility, can not be put to the intended use. This limitation shall not apply in the case of mandatory liability based on intent, gross negligence or injury of life, body or health; this does not imply a change in the burden of proof to the detriment of the Purchaser. The right of the Purchaser to cancel the contract shall remain unaffected.
2. Where unforeseeable events within the meaning of Art. IV No. 2 substantially change the economic importance or the contents of the Supplies or considerably affect the Supplier's business, the contract shall be adapted taking into account the principles of reasonableness and good faith. Where doing so is economically unreasonable, the Supplier shall have the right to cancel the contract. If the Supplier intends to exercise its right to cancel the contract, it shall notify the Purchaser thereof without undue delay after having realised the repercussions of the event; this shall also apply even where an extension of the delivery period had previously been agreed with the Purchaser.

XI. Other claim es for damages

1. Any claims for damages and reimbursement of expenses the Purchaser may have (hereinafter referred to as „Claims for Damages“), based on whatever legal reason, including infringement of duties arising in connection with the contract or tort, shall be excluded.
2. The above shall not apply in the case of mandatory liability, e.g. under the German Product Liability Act („Produkthaftungsgesetz“), in the case of intent, gross negligence, injury of life, body or health, or breach of a condition which goes to the root of the contract („wesentliche Vertragspflichten“). However, Claims for Damages arising from a breach of a condition which goes to the root of the contract shall be limited to the foreseeable damage which is intrinsic to the contract, unless caused by intent or gross negligence or based on liability for injury of life, body or health. The above provision does not imply a change in the burden of proof to the detriment of the Purchaser.
3. To the extent that the Purchaser has a valid Claim for Damages according to this Art. XI, it shall be time-barred upon expiration of the limitation period applicable to Defects pursuant to Art. VIII No. 2. In the case of claims for damages under the German Product Liability Act, the statutory provisions governing limitation periods shall apply.

XII. Venue and applicable law

1. If the Purchaser is a businessperson, sole venue for all disputes arising directly or indirectly out of the contract shall be the Supplier's place of business. However, the Supplier may also bring an action at the Purchaser's place of business.
2. Legal relations existing in connection with this contract shall be governed by German substantive law, to the exclusion of the United Nations Convention on Contracts for the International Sale of Goods (CISG).

XIII. Severability clause

The legal invalidity of one or more provisions of this contract shall in no way affect the validity of the remaining provisions. This shall not apply if it would be unreasonable for one of the parties to continue the contract.

XIV. Catalogue information

Only the catalogue valid at the time of the conclusion of the contract shall apply. All previous catalogues and the information therein shall be rendered invalid by the catalogue applicable at the time of concluding the contract.

All technical values of the supplier's product stated in the catalogue are average values determined from electronically-held operational data.

Guarantee Terms 01/2011

1. The following guarantee terms shall apply to any products supplied by the Supplier. Statutory warranty rights (supplementary performance, rescission or reduction of the purchase price, damages) are not affected by this guarantee. This guarantee shall be considered as a voluntary promise by the Supplier towards the purchaser and shall not affect the seller's warranty obligation under the contract of sale with the purchaser.
2. From the date of delivery to the purchaser, Supplier grants a 60 months' guarantee period for products labelled „HÜCO“ and with HÜCO branded package, and a 36 months' guarantee period for any other of Supplier's products. Wear and tear parts, which may be components of Supplier's products, are excluded from this guarantee.
3. This guarantee covers solely defects as to quality, i.e. material defects or manufacturing defects. Wear and tear is excluded from the guarantee, as are insignificant deviations from the agreed quality, only minor impairment of usefulness, damage arising after the transfer of risks from faulty or negligent handling, excessive strain, unsuitable equipment, defective workmanship and from particular external influences not assumed under the contract. Furthermore, the guarantee does not cover components which were not integrated and/or not approved by Supplier and the consequences thereof. Defects or damage arising from repair work carried out by third parties – i.e. by anybody else than Supplier or his authorized contractors – or from other unauthorized

interventions shall be likewise excluded, as well as defects due to chemical or electrochemical exposure, inappropriate utilization, defective installation or connection, extreme atmospheric exposure, non-observance of installation instructions or maintenance guidelines and damage in transit.

4. In case of a defect, the purchaser is obliged to inform Supplier of the defect in writing and without undue delay, describing the alleged defect. If the defect is covered by this guarantee, Supplier will, in his discretion, provide subsequent performance or repair the defect product. In case of no defect covered by this guarantee, purchaser is obliged to compensate Supplier for his expenses induced by the notice of defects.

5. This guarantee does not cover transport costs for sending the defect product to the supplier, nor the risks of loss and damage during this transport.

6. Other or further claims, in particular claims for compensation beyond the damage to the product, shall be excluded unless the law or contractual terms provide for mandatory liability.

HÜCO Automotive GmbH

EMV, EU Direktive 2009/19/EG

Die Europäische Kommission hat die Richtlinie 2009/19/EG (2004/104/EG) bezüglich der Elektromagnetischen Verträglichkeit (EMV) von motorbetriebenen Fahrzeugen und deren elektrischen und elektronischen Komponenten am 12. März 2009 verabschiedet.

Diese Richtlinie ersetzt die vorherige Kraftfahrzeug EMV Richtlinie 95/54/EG.

Sie enthält in ihren Anhängen sämtliche technischen Anforderungen die notwendig sind, um die Übereinstimmung mit den Anforderungen der Richtlinie zu demonstrieren. Diese Anforderungen stellen sicher, dass elektronische Baugruppen, die dieser Richtlinie entsprechen, keine störenden Signale aussenden bzw. durch externe elektromagnetische Strahlungsquellen in ihrer Funktion nicht beeinträchtigt werden. Gekennzeichnete Baugruppen müssen von akkreditierter Stelle geprüft worden sein.

Uns liegen inzwischen für alle relevanten Automotive Baugruppen aus unserem Hause die EMV Zertifikate des KBA vor. Abhängig von der Produktgruppe sind diese verschiedenen EMV Typgenehmigungsnummern mit dem jeweils entsprechenden Kennzeichen versehen:

Kraftstoffpumpenrelais:

e1*72/245*2009/19*6064*00, e1 Kennzeichen = e1 036064

Glühzeitsteuergeräte:

e1*72/245*2009/19*6063*00, e1 Kennzeichen = e1 036063

Kraftstoffpumpen:

e1*72/245*2009/19*6064*00, e1 Kennzeichen = e1 036064

Diese e1 - Kennzeichen werden Sie auch auf den Endprodukten unserer o.g. Produktgruppen finden. So haben Sie die Sicherheit, von uns nur zertifizierte Produkte zu bekommen.

Damit verschaffen wir Ihnen bei Ihrem Geschäft einen Wettbewerbsvorteil gegenüber Ihren Mitbewerbern ohne Zertifikat.

Mit der Richtlinie 2009/19/EG wird die bisher für Nachrüstteile erforderliche Bestätigung eines technischen Dienstes nicht mehr erforderlich, sofern sie die Störfestigkeit des Fahrzeuges nicht beeinträchtigen und nicht sicherheitsrelevant sind. Elektronische Baugruppen, die typischerweise als sogenannte Nachrüstteile verkauft werden sind zum Beispiel unsere Spannungswandler.

EMC,EEC-directive 2009/19/EG

The European commission passed the directive 2009/19/EG (2007/104/EG) relating to electromagnetic compatibility (EMC) concerning the EMC of motor vehicles and their electric and electronic components on March 12, 2009.

This directive replaces the previous automotive EMC directive 95/54/EC. It contains in its annexes all the technical requirements necessary to demonstrate conformity with the requirements. These requirements make sure that those electronic components which correspond to the standards, do not send out any interfering electro-magnetic waves or are affected in their functions by external electro-magnetic radiation. Components which are specified according to this directive must have been tested and approved by an authorized institution.

By now, we have received EMC-certificates from the KBA for every relevant component of our product-range. Depending on the product-group the different EMC-approval numbers are combined with the corresponding identification numbers:

fuel pump relays:

e1*72/245*2009/19*6064*00, e1 identification no. = e1 036064

glow plug controllers:

e1*72/245*2009/19*6063*00, e1 identification no. = e1 036063

fuel pumps:

e1*72/245*2009/19*6064*00, e1 identification no. = e1 036064

These e1 – identification numbers are also stated on the final products of our a. m. product groups. This gives you the guarantee that you will only receive certified products from us. This way, we provide you with a clear business advantage compared to your competitors who have no certificates.

According to the directive 2009/19/EG (2007/104/EG) the former needed type approval for aftermarket equipment by an accredited technical service is no longer necessary, if they are not related to immunity-related functions. Electronic sub-assemblies sold as typical so called aftermarket equipment are our voltage converters.

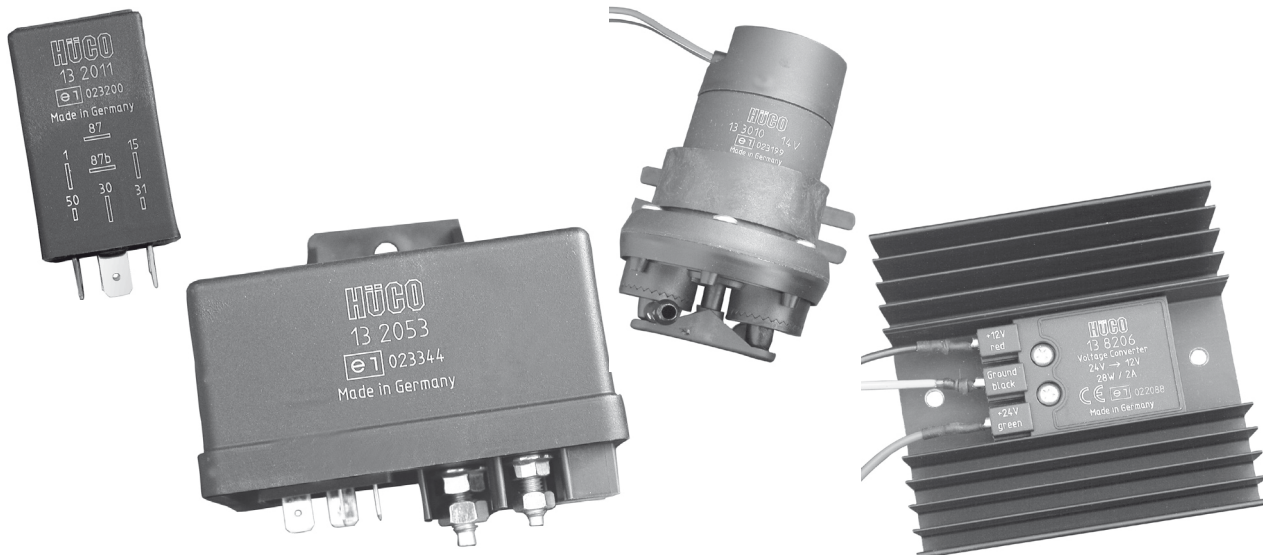



DET NORSKE VERITAS MANAGEMENT SYSTEM CERTIFICATE

Certificate No. 50791-2009-AQ-GER-IATF
IATF Certificate No. 0088009
Page 1 of 1

This is to certify that the Management System of
HÜCO electronic GmbH

Von dem Bussche-Münch-Straße 12, 32339 Espelkamp, Germany
Remote Supporting Functions: None
has been found to conform to Technical Specification:

ISO/TS 16949:2002
having been audited in accordance with the:
Rules for the registration scheme for ISO/TS 16949:2002 - 2nd Edition.
This Certificate is valid for the following products/service ranges:

**DEVELOPMENT, PRODUCTION, AND
ASSEMBLING OF ELECTRONIC PRODUCTS**
EXCLUSIONS: NONE

Initial Certification date:
02 September 2009

This Certificate is valid until:
01 September 2012

Frank-Michael Knop
Frank-Michael Knop
Lead Auditor



Place and date:
Katy, Texas, 02 September 2009
for the Accredited Unit:
DET NORSKE VERITAS
CERTIFICATION INC., KATY, TX, USA

Robert Kozak
Robert Kozak
Management Representative

Audit conducted by DNV Office located in Essen, Germany.
HEAD OFFICE: DET NORSKE VERITAS CERTIFICATION, INC. 1400 RAYVILLO DRIVE, KATY, TEXAS 77449. TEL: (281) 396-1000. FAX: (281) 396-1903



DET NORSKE VERITAS MANAGEMENT SYSTEM CERTIFICATE

Certificate No. CERT-11910-2007-AQ-HOU-IATF
IATF Certificate No. 0046348
Page 1 of 1

This is to certify that the Quality Management System of
HUECO ELECTRONIC (I) PVT. LTD.

Plot No.1, Indo German Technology Park, Survey No 297,298,299, Village Urwade,
at
Taluka: Mulshi Pune, Maharashtra, Pin -412 108, India
Remote Supporting Functions - None
has been found to conform to Technical Specification:

ISO/TS 16949:2002
having been audited in accordance with the:
Rules for the registration scheme for ISO/TS 16949:2002 - 2nd Edition.
This Certificate is valid for the following products/service ranges:

DEVELOPMENT AND PRODUCTION OF ELECTRONIC PRODUCTS
EXCLUSIONS: NONE

Place and date:
Houston, Texas, 14 March 2007
for the Accredited Unit:
DET NORSKE VERITAS CERTIFICATION, INC.
Houston, TX, USA

Robert Kozak
Robert Kozak
Management Representative
Det Norske Veritas Certification, Inc.



This certificate is valid until:
8 March 2010
Initial Certification Date:
9 March 2007

Manish Thakurdas
Manish Thakurdas
Lead Auditor

Audit Conducted by DNV Office located in Essen, Germany.

HÜCO®

MITGLIED/MEMBER

GVA
GESAMTVERBAND
AUTOTEILE-HANDEL

PARTSLIFE

VDA

Verband der
Automobilindustrie

HÜCO® **HÜCO Automotive GmbH**

Eugen-Gerstenmaier-Str. 8
Postfach 12 28
32326 Espelkamp / Germany

Telefon +49 (0) 57 72 / 5 67 - 890
Telefax +49 (0) 57 72 / 5 67 - 985
E-Mail info@hueco.com
Internet www.hueco.com