











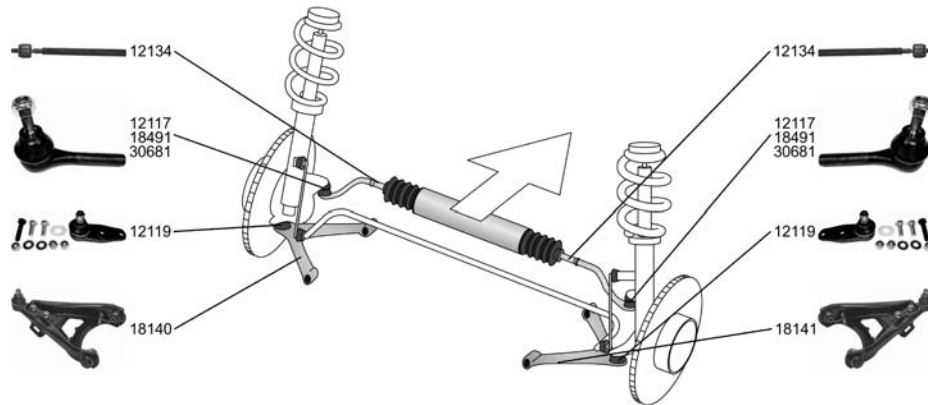



OE

# RENAULT

R 21 (B48\_)

09.89 - 06.94













<p><b>Spurstange / Tie Rod, steering</b></p> <p>1.7 (B48F) 09.89 - 10.92 1.7 (B48E) 09.89 - 06.94</p>		<p><b>12133</b> 77 01 464 015 12134 12117</p> 
<p><b>Spurstangenkopf / Tie-rod End</b> mit Zubehör / With accessories Gewindeart: mit Rechtsgewinde / Thread Type: with right-hand thread Aussengewinde 1 [mm] / Outer Thread 1 [mm]:M14x1,5 Aussengewinde [mm] / Outer Thread [mm]:M10x1,5</p> <p>(B48D) 09.89 - 05.93 1.7 (B48E) 09.89 - 06.94 1.9 D (B48H, B48I) 09.89 - 10.93</p>		<p><b>12117</b> 77 01 469 231</p> 
<p><b>Spurstangenkopf / Tie-rod End</b> Gewindeart: mit Rechtsgewinde / Thread Type: with right-hand thread Gewindemaß / Thread Size:M12x1,25 Aussengewinde [mm] / Outer Thread [mm]:M14x1,5</p> <p>2.1 Turbo-D (B486, B488, B48V) 09.89 - 06.94</p>		<p><b>18491</b> 77 01 464 693</p> 
<p><b>Spurstangenkopf / Tie-rod End</b> Gewindeart: mit Rechtsgewinde / Thread Type: with right-hand thread Gewindemaß / Thread Size:M10x1,25 Aussengewinde [mm] / Outer Thread [mm]:M14x1,5</p> <p>2.0 (B48C) 09.89 - 12.93 2.0 (B48R/Y) 02.90 - 10.92 2.0 4x4 (B48R/Y) 09.90 - 10.92 2.2 (B48K) 09.89 - 06.94 2.2 4x4 (B48K) 07.90 - 06.94 2.1 D (B48V/B48O) 09.89 - 12.92</p>	  Baumuster / Model:B48V	<p><b>30681</b> 77 01 469 230</p>
<p><b>Axialgelenk, Spurstange / Axial Rod, tie rod</b> für OE / for OE 77 01 465 917</p> <p>1.7 (B48F) 09.89 - 10.92 1.7 (B48E) 09.89 - 06.94</p>		<p><b>12134</b></p> 
<p><b>Lenker, Radaufhängung / Track Control Arm</b> mit Gummilager / with rubber mounting</p> <p>1.7 (B48F) 09.89 - 10.92 1.7 (B48E) 09.89 - 06.94</p>		<p><b>18140</b> 77 00 783 449</p> 
<p><b>Lenker, Radaufhängung / Track Control Arm</b> mit Gummilager / with rubber mounting</p> <p>1.7 (B48F) 09.89 - 10.92 1.7 (B48E) 09.89 - 06.94</p>		<p><b>18141</b> 77 00 783 450</p> 



# RENAULT

R 21 (B48\_)





09.89 - 06.94

	<b>Trag-/Führungsgelenk / Support-/ Steering Link</b> mit Zubehör / With accessories Gewindemaß / Thread Size:M10		A16	<b>12119</b>	77 01 468 883	
	1.7 (B48F) 09.89 - 10.92 1.7 (B48E) 09.89 - 06.94					
	<b>Trag-/Führungsgelenk / Support-/ Steering Link</b>			<b>12135</b>	77 01 464 037	
	2.0 (B48C) 09.89 - 12.93 2.0 (B48R/Y) 02.90 - 10.92 2.0 4x4 (B48R/Y) 09.90 - 10.92 2.2 (B48K) 09.89 - 06.94 2.2 4x4 (B48K) 07.90 - 06.94 1.9 D (B48H, B48I) 09.89 - 10.93 2.1 D (B480) 04.92 - 06.94 2.1 D (B48V/B48O) 09.89 - 12.92 2.1 Turbo-D (B486, B488, B48V) 09.89 - 06.94					
	<b>Lagerung, Lenker / Mounting, wishbone</b>		I12/A32	<b>22477</b>	77 04 000 681	
	1.7 (B48F) 09.89 - 10.92 1.7 (B48E) 09.89 - 06.94					
	<b>Faltenbalgsatz, Lenkung / Bellow Kit, steering system</b> Innendurchmesser 1 [mm] / Inner Diameter 1 [mm]:10 Innendurchmesser 2 [mm] / Inner Diameter 2 [mm]:40			<b>30154</b>	77 01 469 617	
	(B48D) 09.89 - 05.93 1.7 (B48F) 09.89 - 10.92 1.7 (B48E) 09.89 - 06.94					
	<b>Achskörperlager / Mounting, axle body</b>			<b>29518</b>	77 00 762 843	
	(B48D) 09.89 - 05.93 1.7 (B48F) 09.89 - 10.92 1.7 (B48E) 09.89 - 06.94 1.9 D (B48H, B48I) 09.89 - 10.93					

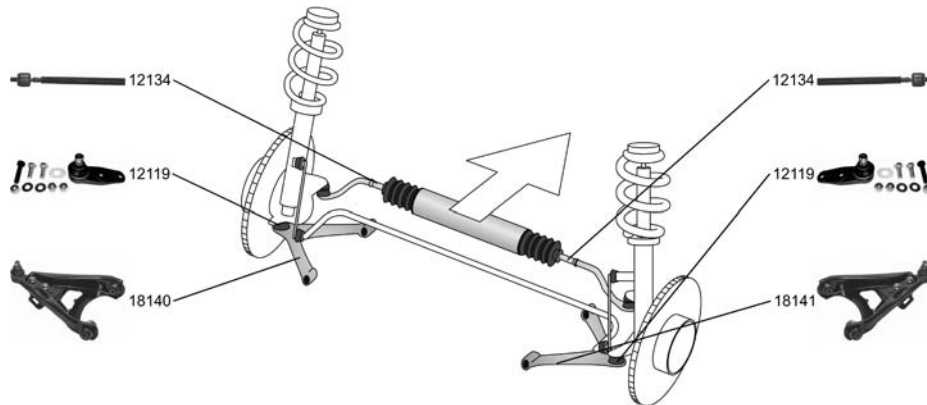
R 21 Kasten/Box/Furgón/Van

06.86 - 08.94









<b>Spurstange / Tie Rod, steering</b>	1.7	06.86 - 04.95		<b>12133</b>	77 01 464 015	12134 12117
						
<b>Axialgelenk, Spurstange / Axial Rod, tie rod</b> für OE / for OE 77 01 465 917	1.7	06.86 - 04.95		<b>12134</b>		



OE



# RENAULT

## R 21 Kasten/Box/Furgón/Van 06.86 - 08.94

 <b>Lenker, Radaufhängung / Track Control Arm</b> mit Gummilager / with rubber mounting 1.7	06.86 - 04.95	▲▼↻	<b>18140</b> 77 00 783 449 
	06.86 - 04.95		
<b>Lenker, Radaufhängung / Track Control Arm</b> mit Gummilager / with rubber mounting 1.7	06.86 - 04.95	▼↻	<b>18141</b> 77 00 783 450 
	06.86 - 04.95		
<b>Trag-/Führungsgelenk / Support-/ Steering Link</b> mit Zubehör / With accessories Gewindemaß / Thread Size:M10 1.7	06.86 - 04.95	▼↻	<b>12119</b> 77 01 468 883 
	06.86 - 04.95		
<b>Trag-/Führungsgelenk / Support-/ Steering Link</b> 1.9 D 2.1 D	06.86 - 08.94		<b>12135</b> 77 01 464 037 
	06.86 - 08.94		
	06.86 - 08.94		
<b>Faltenbalgsatz, Lenkung / Bellow Kit, steering system</b> Innendurchmesser 1 [mm] / Inner Diameter 1 [mm]:10 Innendurchmesser 2 [mm] / Inner Diameter 2 [mm]:40 1.7	06.86 - 04.95	☰↻	<b>30154</b> 77 01 469 617 
	06.86 - 04.95		

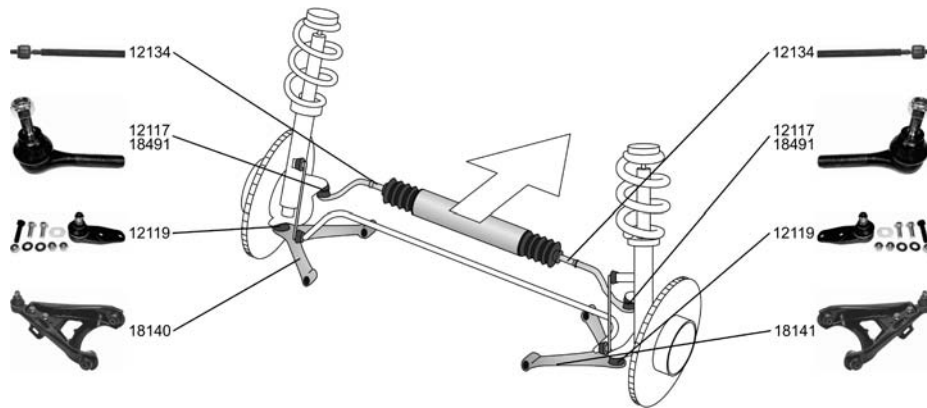
## R 21 Kombi/Estate/Break (K48\_) 03.86 - 08.94

















<b>Spurstange / Tie Rod, steering</b> 1.7 (K48F) KAT 1.7 (K/S481) 1.7 (K48N) 1.7 (K/S482) 1.7 (K48E) 2.0 (K483) 2.1 D (K480)	05.88 - 06.93		<b>12133</b> 77 01 464 015 12134 12117 
	06.86 - 03.93		
	06.87 - 04.89		
	10.86 - 12.88		
	06.86 - 12.93		
	06.86 - 12.88		
	02.92 - 09.95		
<b>Spurstangenkopf / Tie-rod End</b> mit Zubehör / With accessories Gewindart: mit Rechtsgewinde / Thread Type: with right-hand thread Aussengewinde 1 [mm] / Outer Thread 1 [mm]:M14x1,5 Aussengewinde [mm] / Outer Thread [mm]:M10x1,5 1.7 (K48M) 1.7 (K48F) KAT 1.7 (K/S481) 1.7 (K48N) 1.7 (K/S482) 1.7 (K48E)	06.86 - 12.89	↻↻	<b>12117</b> 77 01 469 231 
	05.88 - 06.93		
	06.86 - 03.93		
	06.87 - 04.89		
	10.86 - 12.88		
	06.86 - 12.93		
	06.86 - 12.93		



# RENAULT

R 21 Kombi/Estate/Break (K48\_)

03.86 - 08.94













<p> <b>Spurstangenkopf / Tie-rod End</b>                      Gewindeart: mit Rechtsgewinde / Thread Type: with right-hand thread                      Gewindemaß / Thread Size:M12x1,25                      Aussengewinde [mm] / Outer Thread [mm]:M14x1,5                      2.1 Turbo-D (K48A, K48W, K487, K488) 10.86 - 11.93</p>		<p><b>18491</b> 77 01 464 693</p> 
<p><b>Spurstangenkopf / Tie-rod End</b>                      Gewindeart: mit Rechtsgewinde / Thread Type: with right-hand thread                      Gewindemaß / Thread Size:M10x1,25                      Aussengewinde [mm] / Outer Thread [mm]:M14x1,5                      2.0 (K483) 06.86 - 12.88                      2.0 (K48R) 06.90 - 02.94                      2.2 (K48K) 06.86 - 11.93                      2.2 4x4 (K48K) 06.86 - 12.93                      2.1 D (K/S486) 10.86 - 09.90                      2.1 D 4x4 (K486) 10.88 - 05.92                      2.1 D (K/S48V, K/S48O) 08.89 - 12.92</p>		<p><b>30681</b> 77 01 469 230</p>
<p><b>Axialgelenk, Spurstange / Axial Rod, tie rod</b>                      für OE / for OE 77 01 465 917                      1.7 (K48F) KAT 05.88 - 06.93                      1.7 (K/S481) 06.86 - 03.93                      1.7 (K48N) 06.87 - 04.89                      1.7 (K/S482) 10.86 - 12.88                      1.7 (K48E) 06.86 - 12.93                      2.0 (K483) 06.86 - 12.88                      2.1 D (K480) 02.92 - 09.95</p>		<p><b>12134</b></p> 
<p><b>Lenker, Radaufhängung / Track Control Arm</b>                      mit Gummilager / with rubber mounting                      1.7 (K48F) KAT 05.88 - 06.93                      1.7 (K/S481) 06.86 - 03.93                      1.7 (K48N) 06.87 - 04.89                      1.7 (K/S482) 10.86 - 12.88                      1.7 (K48E) 06.86 - 12.93                      2.0 (K483) 06.86 - 12.88                      2.1 D (K480) 02.92 - 09.95</p>		<p><b>18140</b> 77 00 783 449</p> 
<p><b>Lenker, Radaufhängung / Track Control Arm</b>                      mit Gummilager / with rubber mounting                      1.7 (K48F) KAT 05.88 - 06.93                      1.7 (K/S481) 06.86 - 03.93                      1.7 (K48N) 06.87 - 04.89                      1.7 (K/S482) 10.86 - 12.88                      1.7 (K48E) 06.86 - 12.93                      2.0 (K483) 06.86 - 12.88                      2.1 D (K480) 02.92 - 09.95</p>		<p><b>18141</b> 77 00 783 450</p> 
<p><b>Trag-/Führungsgelenk / Support-/ Steering Link</b>                      mit Zubehör / With accessories                      Gewindemaß / Thread Size:M10                      1.7 (K48F) KAT 05.88 - 06.93                      1.7 (K/S481) 06.86 - 03.93                      1.7 (K48N) 06.87 - 04.89                      1.7 (K/S482) 10.86 - 12.88                      1.7 (K48E) 06.86 - 12.93                      2.0 (K483) 06.86 - 12.88                      2.1 D (K480) 02.92 - 09.95</p>		<p><b>12119</b> 77 01 468 883</p> 
<p><b>Trag-/Führungsgelenk / Support-/ Steering Link</b>                      1.7 (K48M) 06.86 - 12.89                      2.0 (K48C) 03.86 - 12.93                      2.0 4x4 03.89 - 12.93                      2.0 (K48R) 06.90 - 02.94                      2.2 (K48K) 06.86 - 11.93                      2.2 4x4 (K48K) 06.86 - 12.93                      1.9 D 03.86 - 08.94                      2.1 D (K/S486) 10.86 - 09.90                      2.1 D 4x4 (K486) 10.88 - 05.92                      2.1 D (K/S48V, K/S48O) 08.89 - 12.92                      2.1 Turbo-D (K48A, K48W, K487, K488) 10.86 - 11.93</p>		<p><b>12135</b> 77 01 464 037</p> 
<p><b>Lagerung, Lenker / Mounting, wishbone</b>                      1.7 (K48M) 06.86 - 12.89                      1.7 (K/S481) 06.86 - 03.93                      1.7 (K48N) 06.87 - 04.89                      1.7 (K/S482) 10.86 - 12.88                      1.7 (K48E), 69 kW 06.86 - 12.89</p>	<p>I12/A32</p>	<p><b>22477</b> 77 04 000 681</p> 



OE



# RENAULT

## R 21 Kombi/Estate/Break (K48\_) 03.86 - 08.94

 <b>Faltenbaldsatz, Lenkung / Bellow Kit, steering system</b> Innendurchmesser 1 [mm] / Inner Diameter 1 [mm]:10 Innendurchmesser 2 [mm] / Inner Diameter 2 [mm]:40	1.7 (K48M) 06.86 - 12.89 1.7 (K48F) KAT 05.88 - 06.93 1.7 (K48N) 06.87 - 04.89 1.7 (K/S482) 10.86 - 12.88 1.7 (K48E) 06.86 - 12.93	  Baumuster / Model:S481	<b>30154</b> 77 01 469 617 
	1.7 (K/S481) 06.86 - 03.93		
<b>Faltenbaldsatz, Lenkung / Bellow Kit, steering system</b> Innendurchmesser 1 [mm] / Inner Diameter 1 [mm]:10 Innendurchmesser 2 [mm] / Inner Diameter 2 [mm]:27,5	1.7 (K/S482) 10.86 - 12.88	 Baumuster / Model:S482	<b>30179</b> 77 01 469 497 
	2.1 D (K/S486) 10.86 - 09.90	 Baumuster / Model:S486	
	2.1 D (K/S48V, K/S480) 08.89 - 12.92	 Baumuster / Model:S48V, S480	
	1.7 (K/S481) 06.86 - 03.93	 Baumuster / Model:S481	
 <b>Achskörperlager / Mounting, axle body</b>	1.7 (K48M) 06.86 - 12.89 1.7 (K48F) KAT 05.88 - 06.93 1.7 (K/S481) 06.86 - 03.93 1.7 (K48N) 06.87 - 04.89 1.7 (K/S482) 10.86 - 12.88 1.7 (K48E) 06.86 - 12.93		<b>29518</b> 77 00 762 843 
	1.7 (K48M) 06.86 - 12.89		
	1.7 (K48F) KAT 05.88 - 06.93		
	1.7 (K/S481) 06.86 - 03.93		
	1.7 (K48N) 06.87 - 04.89		
	1.7 (K/S482) 10.86 - 12.88		
	1.7 (K48E) 06.86 - 12.93		

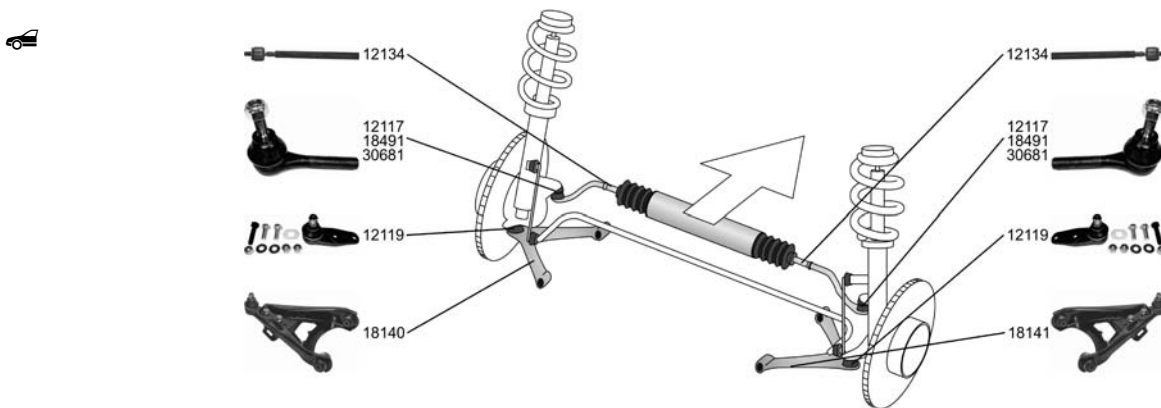
## R 21 Stufenheck/Saloon/avec coffre (L48\_) 03.86 - 06.94















<b>Spurstange / Tie Rod, steering</b> 1.4 (L48D) 06.88 - 10.93 1.7 (L48M, L48F) 07.86 - 02.94 1.7 (L481) 03.86 - 12.87 1.7 (L48N) 06.87 - 04.89 1.7 (L482) 03.86 - 03.93 1.7 (L48E) 03.86 - 02.94		<b>12133</b> 77 01 464 015 12134 12117 
<b>Spurstangenkopf / Tie-rod End</b> mit Zubehör / With accessories Gewindeart: mit Rechtsgewinde / Thread Type: with right-hand thread Aussengewinde 1 [mm] / Outer Thread 1 [mm]:M14x1,5 Aussengewinde [mm] / Outer Thread [mm]:M10x1,5		<b>12117</b> 77 01 469 231 
	1.4 (L48D) 06.88 - 10.93	
	1.7 (L48M, L48F) 07.86 - 02.94	
	1.7 (L48N) 06.87 - 04.89	
	1.7 (L482) 03.86 - 03.93	
	1.7 (L48E) 03.86 - 02.94	
	1.9 D (L48H, L48I) 08.89 - 10.93	



# RENAULT

R 21 Stufenheck/Saloon/avec coffre  
(L48\_)

03.86 - 06.94







<p> <b>Spurstangenkopf / Tie-rod End</b> Gewindeart: mit Rechtsgewinde / Thread Type: with right-hand thread Gewindemaß / Thread Size:M12x1,25 Aussengewinde [mm] / Outer Thread [mm]:M14x1,5</p> <table border="1"> <tr><td>2.0 Turbo (L48L)</td><td>02.90 - 10.92</td></tr> <tr><td>2.0 Turbo 4x4 (L48L)</td><td>02.90 - 10.92</td></tr> <tr><td>2.0 Turbo (L485)</td><td>04.87 - 03.90</td></tr> <tr><td>2.0 Turbo 4x4</td><td>08.89 - 10.93</td></tr> <tr><td>2.1 Turbo-D (L48A, L48W, L487, L488)</td><td>03.86 - 06.94</td></tr> </table>	2.0 Turbo (L48L)	02.90 - 10.92	2.0 Turbo 4x4 (L48L)	02.90 - 10.92	2.0 Turbo (L485)	04.87 - 03.90	2.0 Turbo 4x4	08.89 - 10.93	2.1 Turbo-D (L48A, L48W, L487, L488)	03.86 - 06.94		<p><b>18491</b>      77 01 464 693</p> 										
2.0 Turbo (L48L)	02.90 - 10.92																					
2.0 Turbo 4x4 (L48L)	02.90 - 10.92																					
2.0 Turbo (L485)	04.87 - 03.90																					
2.0 Turbo 4x4	08.89 - 10.93																					
2.1 Turbo-D (L48A, L48W, L487, L488)	03.86 - 06.94																					
<p><b>Spurstangenkopf / Tie-rod End</b> Gewindeart: mit Rechtsgewinde / Thread Type: with right-hand thread Gewindemaß / Thread Size:M10x1,25 Aussengewinde [mm] / Outer Thread [mm]:M14x1,5</p> <table border="1"> <tr><td>2.0 (L489)</td><td>03.86 - 10.93</td></tr> <tr><td>2.0</td><td>05.91 - 10.93</td></tr> <tr><td>2.0 (L483)</td><td>03.86 - 12.88</td></tr> <tr><td>2.0 (L48C)</td><td>03.86 - 12.93</td></tr> <tr><td>2.0 (L48R)</td><td>02.90 - 06.94</td></tr> <tr><td>2.0 4x4 (L48R)</td><td>12.89 - 02.94</td></tr> <tr><td>2.2 (L48K)</td><td>07.86 - 02.94</td></tr> <tr><td>2.2 4x4 (L48K)</td><td>07.90 - 02.94</td></tr> <tr><td>2.1 D (L486)</td><td>03.86 - 12.89</td></tr> <tr><td>2.1 D (L48V, L48O)</td><td>05.89 - 06.94</td></tr> </table>	2.0 (L489)	03.86 - 10.93	2.0	05.91 - 10.93	2.0 (L483)	03.86 - 12.88	2.0 (L48C)	03.86 - 12.93	2.0 (L48R)	02.90 - 06.94	2.0 4x4 (L48R)	12.89 - 02.94	2.2 (L48K)	07.86 - 02.94	2.2 4x4 (L48K)	07.90 - 02.94	2.1 D (L486)	03.86 - 12.89	2.1 D (L48V, L48O)	05.89 - 06.94		<p><b>30681</b>      77 01 469 230</p>
2.0 (L489)	03.86 - 10.93																					
2.0	05.91 - 10.93																					
2.0 (L483)	03.86 - 12.88																					
2.0 (L48C)	03.86 - 12.93																					
2.0 (L48R)	02.90 - 06.94																					
2.0 4x4 (L48R)	12.89 - 02.94																					
2.2 (L48K)	07.86 - 02.94																					
2.2 4x4 (L48K)	07.90 - 02.94																					
2.1 D (L486)	03.86 - 12.89																					
2.1 D (L48V, L48O)	05.89 - 06.94																					
<p><b>Axialgelenk, Spurstange / Axial Rod, tie rod</b> für OE / for OE 77 01 465 917</p> <table border="1"> <tr><td>1.4 (L48D)</td><td>06.88 - 10.93</td></tr> <tr><td>1.7 (L48M, L48F)</td><td>07.86 - 02.94</td></tr> <tr><td>1.7 (L481)</td><td>03.86 - 12.87</td></tr> <tr><td>1.7 (L48N)</td><td>06.87 - 04.89</td></tr> <tr><td>1.7 (L482)</td><td>03.86 - 03.93</td></tr> <tr><td>1.7 (L48E)</td><td>03.86 - 02.94</td></tr> </table>	1.4 (L48D)	06.88 - 10.93	1.7 (L48M, L48F)	07.86 - 02.94	1.7 (L481)	03.86 - 12.87	1.7 (L48N)	06.87 - 04.89	1.7 (L482)	03.86 - 03.93	1.7 (L48E)	03.86 - 02.94		<p><b>12134</b></p> 								
1.4 (L48D)	06.88 - 10.93																					
1.7 (L48M, L48F)	07.86 - 02.94																					
1.7 (L481)	03.86 - 12.87																					
1.7 (L48N)	06.87 - 04.89																					
1.7 (L482)	03.86 - 03.93																					
1.7 (L48E)	03.86 - 02.94																					
<p><b>Lenker, Radaufhängung / Track Control Arm</b> mit Gummilager / with rubber mounting</p> <table border="1"> <tr><td>1.4 (L48D)</td><td>06.88 - 10.93</td></tr> <tr><td>1.7 (L48M, L48F)</td><td>07.86 - 02.94</td></tr> <tr><td>1.7 (L481)</td><td>03.86 - 12.87</td></tr> <tr><td>1.7 (L48N)</td><td>06.87 - 04.89</td></tr> <tr><td>1.7 (L482)</td><td>03.86 - 03.93</td></tr> <tr><td>1.7 (L48E)</td><td>03.86 - 02.94</td></tr> </table>	1.4 (L48D)	06.88 - 10.93	1.7 (L48M, L48F)	07.86 - 02.94	1.7 (L481)	03.86 - 12.87	1.7 (L48N)	06.87 - 04.89	1.7 (L482)	03.86 - 03.93	1.7 (L48E)	03.86 - 02.94		<p><b>18140</b>      77 00 783 449</p> 								
1.4 (L48D)	06.88 - 10.93																					
1.7 (L48M, L48F)	07.86 - 02.94																					
1.7 (L481)	03.86 - 12.87																					
1.7 (L48N)	06.87 - 04.89																					
1.7 (L482)	03.86 - 03.93																					
1.7 (L48E)	03.86 - 02.94																					
<p><b>Lenker, Radaufhängung / Track Control Arm</b> mit Gummilager / with rubber mounting</p> <table border="1"> <tr><td>1.4 (L48D)</td><td>06.88 - 10.93</td></tr> <tr><td>1.7 (L48M, L48F)</td><td>07.86 - 02.94</td></tr> <tr><td>1.7 (L481)</td><td>03.86 - 12.87</td></tr> <tr><td>1.7 (L48N)</td><td>06.87 - 04.89</td></tr> <tr><td>1.7 (L482)</td><td>03.86 - 03.93</td></tr> <tr><td>1.7 (L48E)</td><td>03.86 - 02.94</td></tr> </table>	1.4 (L48D)	06.88 - 10.93	1.7 (L48M, L48F)	07.86 - 02.94	1.7 (L481)	03.86 - 12.87	1.7 (L48N)	06.87 - 04.89	1.7 (L482)	03.86 - 03.93	1.7 (L48E)	03.86 - 02.94		<p><b>18141</b>      77 00 783 450</p> 								
1.4 (L48D)	06.88 - 10.93																					
1.7 (L48M, L48F)	07.86 - 02.94																					
1.7 (L481)	03.86 - 12.87																					
1.7 (L48N)	06.87 - 04.89																					
1.7 (L482)	03.86 - 03.93																					
1.7 (L48E)	03.86 - 02.94																					
<p><b>Trag-/Führungsgelenk / Support-/ Steering Link</b> mit Zubehör / With accessories Gewindemaß / Thread Size:M10</p> <table border="1"> <tr><td>1.4 (L48D)</td><td>06.88 - 10.93</td></tr> <tr><td>1.7 (L48M, L48F)</td><td>07.86 - 02.94</td></tr> <tr><td>1.7 (L48F) KAT</td><td>07.89 - 02.94</td></tr> <tr><td>1.7 (L481)</td><td>03.86 - 12.87</td></tr> <tr><td>1.7 (L48N)</td><td>06.87 - 04.89</td></tr> <tr><td>1.7 (L482)</td><td>03.86 - 03.93</td></tr> <tr><td>1.7 (L48E)</td><td>03.86 - 02.94</td></tr> </table>	1.4 (L48D)	06.88 - 10.93	1.7 (L48M, L48F)	07.86 - 02.94	1.7 (L48F) KAT	07.89 - 02.94	1.7 (L481)	03.86 - 12.87	1.7 (L48N)	06.87 - 04.89	1.7 (L482)	03.86 - 03.93	1.7 (L48E)	03.86 - 02.94	 <p>A16</p>	<p><b>12119</b>      77 01 468 883</p> 						
1.4 (L48D)	06.88 - 10.93																					
1.7 (L48M, L48F)	07.86 - 02.94																					
1.7 (L48F) KAT	07.89 - 02.94																					
1.7 (L481)	03.86 - 12.87																					
1.7 (L48N)	06.87 - 04.89																					
1.7 (L482)	03.86 - 03.93																					
1.7 (L48E)	03.86 - 02.94																					



OE

# RENAULT

**R 21 Stufenheck/Saloon/avec coffre (L48\_) 03.86 - 06.94**

	<b>Trag-/Führungsgelenk / Support-/ Steering Link</b>	<ul style="list-style-type: none"> <li>1.7 (L48F) KAT 07.89 - 02.94</li> <li>2.0 (L489) 03.86 - 10.93</li> <li>2.0 05.91 - 10.93</li> <li>2.0 (L483) 03.86 - 12.88</li> <li>2.0 (L48C) 03.86 - 12.93</li> <li>2.0 (L48R) 02.90 - 06.94</li> <li>2.0 4x4 (L48R) 12.89 - 02.94</li> <li>2.0 Turbo (L48L) 02.90 - 10.92</li> <li>2.0 Turbo 4x4 (L48L) 02.90 - 10.92</li> <li>2.0 Turbo (L485) 04.87 - 03.90</li> <li>2.0 Turbo 4x4 08.89 - 10.93</li> <li>2.2 (L48K) 07.86 - 02.94</li> <li>2.2 4x4 (L48K) 07.90 - 02.94</li> <li>1.9 D (L48H, L48I) 08.89 - 10.93</li> <li>2.1 D (L486) 03.86 - 12.89</li> <li>2.1 D (L480) 10.92 - 06.94</li> <li>2.1 D (L48V, L48O) 05.89 - 06.94</li> <li>2.1 Turbo-D (L48A, L48W, L487, L488) 03.86 - 06.94</li> </ul>	<p><b>12135</b> 77 01 464 037</p>	
	<b>Lagerung, Lenker / Mounting, wishbone</b>	<ul style="list-style-type: none"> <li>1.7 (L48M, L48F) 07.86 - 02.94</li> <li>1.7 (L48F) KAT 07.89 - 02.94</li> <li>1.7 (L481) 03.86 - 12.87</li> <li>1.7 (L48N) 06.87 - 04.89</li> <li>1.7 (L482) 03.86 - 03.93</li> <li>1.7 (L48E), 69 kW 03.86 - 02.94</li> </ul>	<p>112/A32 <b>22477</b> 77 04 000 681</p>	
	<b>Faltenbalgsatz, Lenkung / Bellow Kit, steering system</b> Innendurchmesser 1 [mm] / Inner Diameter 1 [mm]:10 Innendurchmesser 2 [mm] / Inner Diameter 2 [mm]:40	<ul style="list-style-type: none"> <li>1.4 (L48D) 06.88 - 10.93</li> <li>1.7 (L48M, L48F) 07.86 - 02.94</li> <li>1.7 (L48F) KAT 07.89 - 02.94</li> <li>1.7 (L48N) 06.87 - 04.89</li> <li>1.7 (L482) 03.86 - 03.93</li> <li>1.7 (L48E) 03.86 - 02.94</li> </ul>	<p><b>30154</b> 77 01 469 617</p>	
	<b>Faltenbalgsatz, Lenkung / Bellow Kit, steering system</b> Innendurchmesser 1 [mm] / Inner Diameter 1 [mm]:10 Innendurchmesser 2 [mm] / Inner Diameter 2 [mm]:27,5 ALL TYPES ausser/except for : 1.7 TL (L 48 K) 03.86 - 12.94	<ul style="list-style-type: none"> <li>1.7 TL (L 48 K) 03.86 - 12.94</li> </ul>	<p><b>30179</b> 77 01 469 497</p>	
	<b>Achskörperlager / Mounting, axle body</b>	<ul style="list-style-type: none"> <li>2.0 (L483) 03.86 - 12.88</li> <li>2.0 (L48C) 03.86 - 12.93</li> <li>2.0 (L48R) 02.90 - 06.94</li> <li>2.0 4x4 (L48R) 12.89 - 02.94</li> <li>2.0 Turbo (L48L) 02.90 - 10.92</li> <li>2.1 D (L486) 03.86 - 12.89</li> <li>2.1 D (L480) 10.92 - 06.94</li> <li>2.1 D (L48V, L48O) 05.89 - 06.94</li> <li>2.1 Turbo-D (L48A, L48W, L487, L488) 03.86 - 06.94</li> </ul>	<p><b>29518</b> 77 00 762 843</p>	

Arithmetische Liste / Part number list

Artikelnummer Article No.	Seite Page	Hersteller Manufacturer	Artikelnummer Article No.	Seite Page	Hersteller Manufacturer
12117	1 1 2	RENAULT			
Spurstangenkopf / Tie-rod End	3 3 5 5				
12119 ▾⊕	2 3 4	RENAULT			
Trag-/Führungsgelenk / Support-/ Steering Link	6				
12133	1 2 3	RENAULT			
Spurstange / Tie Rod, steering	5				
12134 ⊕⊗	1 1 2	RENAULT			
Axialgelenk, Spurstange / Axial Rod, tie rod	2 4 6				
12135	2 3 4	RENAULT			
Trag-/Führungsgelenk / Support-/ Steering Link	7				
18140 ▲▾⊗	1 3 4	RENAULT			
Lenker, Radaufhängung / Track Control Arm	6				
18141 ▾⊕	1 3 4	RENAULT			
Lenker, Radaufhängung / Track Control Arm	6				
18491 ⊕⊗	1 4 6	RENAULT			
Spurstangenkopf / Tie-rod End					
22477	2 4 7	RENAULT			
Lagerung, Lenker / Mounting, wishbone					
29518 ⊕	2 5 7	RENAULT			
Achskörperlager / Mounting, axle body					
30154	2 3 5	RENAULT			
Faltenbalgsatz, Lenkung / Bellow Kit, steering system	7				
30179	5 7	RENAULT			
Faltenbalgsatz, Lenkung / Bellow Kit, steering system					
30681 ⊕⊗	1 4 6	RENAULT			
Spurstangenkopf / Tie-rod End					

**Vergleichsliste / Cross reference list**

Vergleichs-Nr. Compare No.	Artikelnummer Article No.	Vergleichs-Nr. Compare No.	Artikelnummer Article No.	Vergleichs-Nr. Compare No.	Artikelnummer Article No.
<b>RENAULT</b>					
77 00 762 843	29518				
77 00 783 449	18140				
77 00 783 450	18141				
77 01 464 015	12133				
77 01 464 037	12135				
77 01 464 693	18491				
77 01 468 883	12119				
77 01 469 230	30681				
77 01 469 231	12117				
77 01 469 231	12117				
77 01 469 497	30179				
77 01 469 617	30154				
77 04 000 681	22477				

**Neuaufnahmen / New to range**

Artikelnummer Article No.	Seite Page	Hersteller Manufacturer	Artikelnummer Article No.	Seite Page	Hersteller Manufacturer
12119 ▾⊕	2 3 4 6	RENAULT			
18141 ▾⊕	1 3 4 6	RENAULT			
22477	2 4 7	RENAULT			
29518 ⊕	2 5 7	RENAULT			
30154	2 3 5 7	RENAULT			
30179	5 7	RENAULT			
30681 ⊕♂	1 4 6	RENAULT			

**Geänderte Bestellnummer / Amended part numbers**

Artikelnummer alt Article No. old	Artikelnummer neu Article No. new	Artikelnummer alt Article No. old	Artikelnummer neu Article No. new	Artikelnummer alt Article No. old	Artikelnummer neu Article No. new
15634	30154				
22747	30179				

**Geänderte Bestellnummer / Amended part numbers**

Artikelnummer neu Article No. new	Artikelnummer alt Article No. old	Artikelnummer neu Article No. new	Artikelnummer alt Article No. old	Artikelnummer neu Article No. new	Artikelnummer alt Article No. old
30154	15634				
30179	22747				